

# MORNSUN®

## WRA\_P - 3WR2 & WRB\_P - 3WR2 Series 3W, WIDE INPUT, ISOLATED & REGULATED DUAL/SINGLE OUTPUT, DC-DC CONVERTER

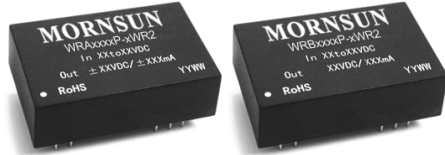

Patent Protection RoHS

### PART NUMBER SYSTEM

WRA2405P-3WR2

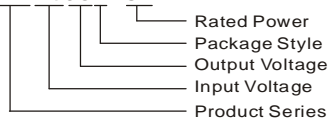

### FEATURES

- 2:1 wide input voltage range
- DIP Package
- Efficiency up to 86%
- 1.5KVDC isolation
- Short Circuit Protection(automatic recovery)
- Temperature range: -40°C ~ +85°C
- Meet CISPR22/EN55022 CLASS A

### APPLICATION

The WRA\_P-3WR2 & WRB\_P-3WR2 Series are specially designed for applications where a wide range input voltage power supplies are unregulated from the input power supply in a distributed power supply system on a circuit board.

These products apply to where:

- 1) Input voltage range  $\leq 2:1$ ;
- 2) 1.5KVDC input and output isolation;
- 3) Output regulated and low ripple noise is required.

### SELECTION GUIDE

Model Number	Input Voltage(VDC)		Output Voltage (VDC)	Output Current (mA)		Input Current (mA)(Typ.)		Reflected Ripple Current (mA, Typ.)	Max. Capacitive Load # ( $\mu$ F)	Efficiency (% Typ.) @ Max. Load
	Nominal (Range)	Max**		Max.	Min.	@Max. Load	@No Load			
WRA0505P-3WR2	5 (4.5-9)	11	±5	±300	±15	800	40	20	2200	75
*WRA0512P-3WR2			±12	±125	±6	790				
*WRA0515P-3WR2			±15	±100	±5	790				
WRB0505P-3WR2			5	600	30	822				
*WRB0512P-3WR2			12	250	13	790				
*WRB0515P-3WR2			15	200	10	790				
*WRA1205P-3WR2	12 (9-18)	20	±5	±300	±15	313	30	30	2200	80
*WRA1212P-3WR2			±12	±125	±6	309				
*WRA1215P-3WR2			±15	±100	±5	305				
WRB1205P-3WR2			12	600	30	313				
*WRB1212P-3WR2			12	250	13	309				
*WRB1215P-3WR2			15	200	10	305				
*WRA2405P-3WR2	24 (18-36)	40	±5	±300	±15	155	15	30	2200	81
*WRA2412P-3WR2			±12	±125	±6	153				
WRA2415P-3WR2			±15	±100	±5	149				
WRB2405P-3WR2			5	600	30	155				
*WRB2412P-3WR2			12	250	13	153				
*WRB2415P-3WR2			15	200	10	149				
*WRA4805P-3WR2	48 (36-75)	80	±5	±300	±15	77	5	5	2200	82
*WRA4812P-3WR2			±12	±125	±6	75				
*WRA4815P-3WR2			±15	±100	±5	74				
WRB4805P-3WR2			5	600	30	77				
*WRB4812P-3WR2			12	250	13	75				
WRB4815P-3WR2			15	200	10	74				

Note: 1. \*Designing. \*\*Input voltage can't exceed this value, or will cause the permanent damage.  
2. # For each output.

INPUT SPECIFICATIONS					
Item	Test Conditions	Min.	Typ.	Max.	Unit
Input Surge Voltage (1sec. max.)	5V input	-0.7	--	12	VDC
	12V input	-0.7	--	25	
	24V input	-0.7	--	50	
	48V input	-0.7	--	100	
Start-up Voltage	5V input	3.5	4	4.5	
	12V input	4.5	8	9	
	24V input	11	16	18	
	48V input	24	33	36	
Input Filter		π Filter			

OUTPUT SPECIFICATIONS					
Item	Test Conditions	Min.	Typ.	Max.	Unit
Output Power		0.15	--	3	W
Output Voltage Accuracy	5% to 100% load	--	±1	±3	%
No load output Voltage Accuracy		--	±1.5	±5	
Output Voltage Balance	Dual output, balanced loads	--	±0.5	±1	
Line Regulation	Full load, Input voltage from low to high	--	±0.2	±0.5	
Load Regulation	5% to 100% load	--	±0.2	±0.5	
Transient Recovery Time	25% load step change	--	0.5	2	
Transient Response Deviation		--	±2	±5	%
Temperature Drift	100% load	--	±0.02	±0.03	%/°C
Ripple*	20MHz Bandwidth	--	30	45	mVp-p
Noise*		--	45	60	
Output Power Protection	Input voltage range	120	--	--	%
Output Short Circuit Protection		Continuous, automatic recovery			
Note: 1. Dual output models unbalanced load: ±5%. 2.* Ripple and noise tested by "parallel cable" method. See detailed operation instructions at Testing of Power Converter section, application notes.					

COMMON SPECIFICATIONS					
Item	Test Conditions	Min.	Typ.	Max.	Unit
Isolation Voltage	Tested for 1 minute and leakage current less than 1 mA	1500	--	--	VDC
Isolation Resistance	Test at 500VDC	1000	--	--	MΩ
Isolation Capacitance	Input/Output, 100KHz/1V	--	120	--	pF
Switching Frequency	100% load, Stand Input voltage	--	200	--	KHz
MTBF	MIL-HDBK-217F @25°C	1000	--	--	K hours
Case Material		Plastic (UL94-V0)			
Weight		--	14	--	g

ENVIRONMENTAL SPECIFICATIONS					
Item	Test Conditions	Min.	Typ.	Max.	Unit
Storage Humidity	Non condensing	--	--	95	%
Operating Temperature	Power derating (above 85°C)	-40	--	85	°C
Storage Temperature		-55	--	125	
Temp. rise at full load	Ta=25°C	--	25	--	
Lead Temperature	1.5mm from case for 10 seconds	--	--	300	
Cooling		Free air convection			

## EMC SPECIFICATIONS

EMI	CE	CISPR22/EN55022	CLASS A(Without External Circuit)/ CLASS B ( External Circuit Refer to Figure1-② or Figure 3 )	
	RE	CISPR22/EN55022	CLASS A(Without External Circuit)/ CLASS B ( External Circuit Refer to Figure1-② or Figure 3 )	
EMS	ESD	IEC/EN61000-4-2	Contact $\pm 4KV$ / Air $\pm 8KV$ perf. Criteria B	
	RS	IEC/EN61000-4-3	10V/m perf. Criteria A	
	EFT	IEC/EN61000-4-4	$\pm 2KV$	perf. Criteria B ( External Circuit Refer to Figure1-① )
		IEC/EN61000-4-4	$\pm 4KV$	perf. Criteria B ( External Circuit Refer to Figure 3 )
	Surge	IEC/EN61000-4-5	$\pm 2KV$	perf. Criteria B ( External Circuit Refer to Figure1-② or Figure 3 )
	CS	IEC/EN61000-4-6	3 Vr.m.s	perf. Criteria A
Voltage dips, short and interruptions immunity		IEC/EN61000-4-29	0%-70% perf. Criteria B	

## EMC RECOMMENDED CIRCUIT

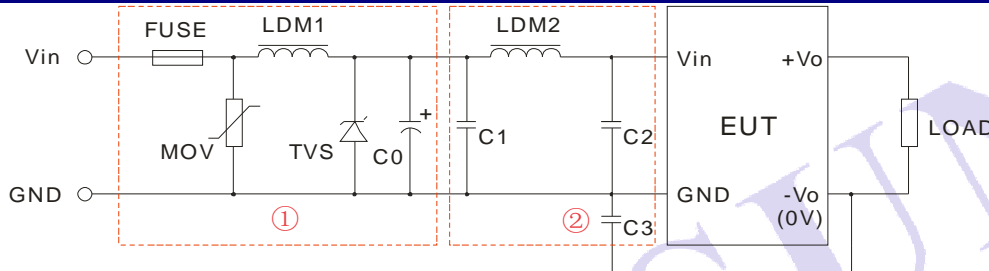

(Figure1)

parameters	Vin:5V	Vin:12V	Vin:24V	Vin:48V
FUSE	Choose according to practical input current			
MOV	--	--	10D560K	10D101K
LDM1	--	--	56 $\mu$ H	
TVS	SMCJ13A	SMCJ28A	SMCJ48A	SMCJ90A
C0	680 $\mu$ F/16V	680 $\mu$ F/25V	120 $\mu$ F/50V	120 $\mu$ F/100V
C1	4.7 $\mu$ F /50V			4.7 $\mu$ F /100V
LDM2	12 $\mu$ H			
C2	4.7 $\mu$ F /50V			4.7 $\mu$ F /100V
C3	1nF/2KV			

Note: 1. In Figure 1, part ① is EMS Recommended external circuit, part ② is EMI recommended external circuit. Choose according to requirements.  
2. If there is no recommended parameters, the model no require the external component.

## EMC RECOMMENDED CIRCUIT PCB LAYOUT

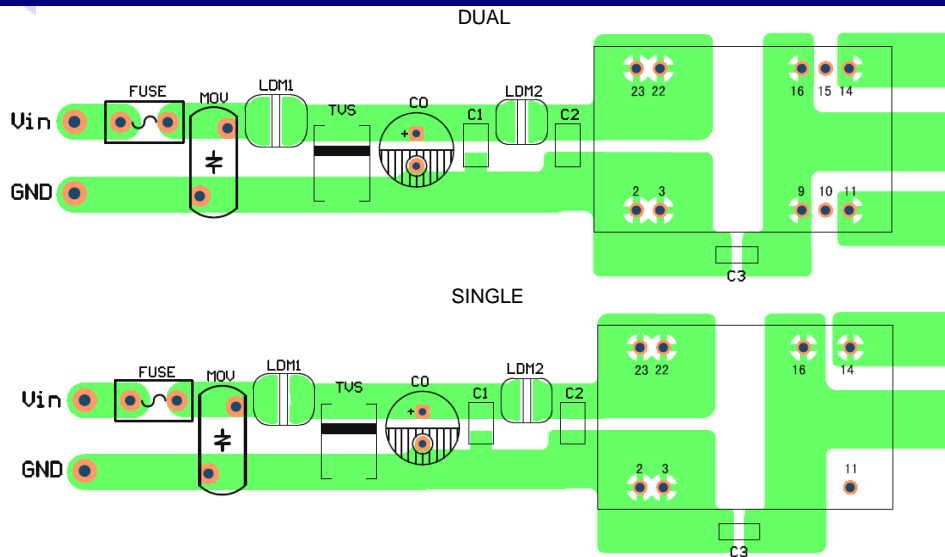

(Figure 2)

## EMC MODULE RECOMMENDED CIRCUIT

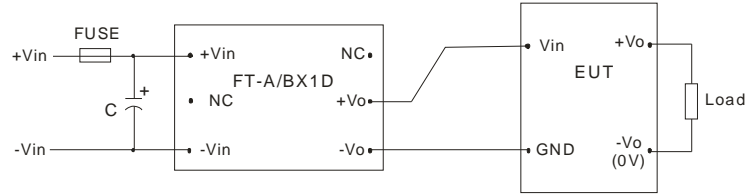

Nominal Voltage < 48V, C ≥ 330uF/50V  
 Nominal Voltage = 48V, C ≥ 330uF/100V

(Figure 3)

## EMC MODULE RECOMMENDED CIRCUIT PCB LAYOUT

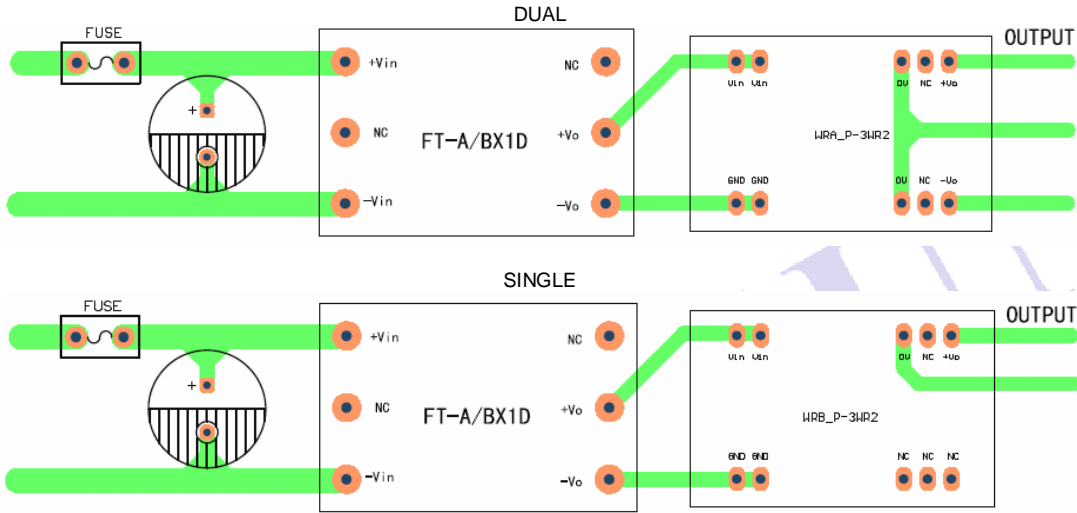

(Figure 4)

## EMI TEST WAVEFORM (NOMINAL AND FULL LOAD)

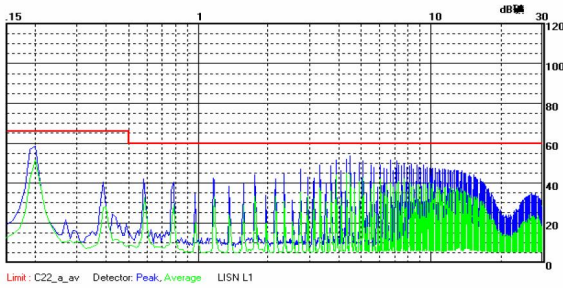

WRA2415P-3WR2 Without External Circuit Power+ (Class A)

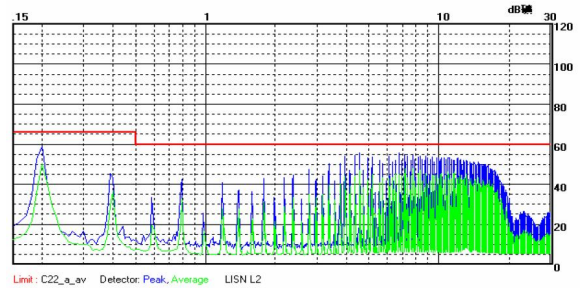

WRA2415P-3WR2 Without External Circuit Power- (Class A)

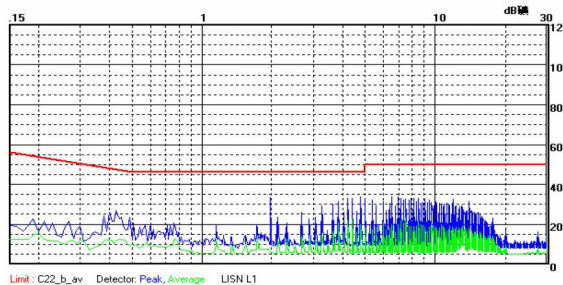

WRA2415P-3WR2 With External Circuit Power+ (Class B)

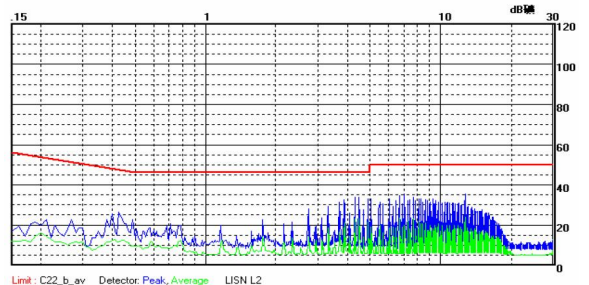

WRA2415P-3WR2 With External Circuit Power- (Class B)

# PRODUCT TYPICAL CURVE

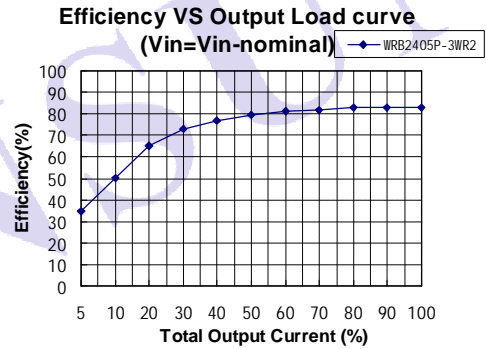
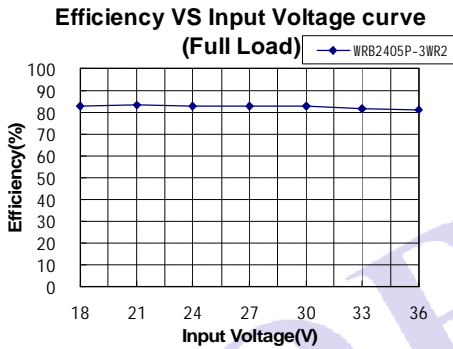
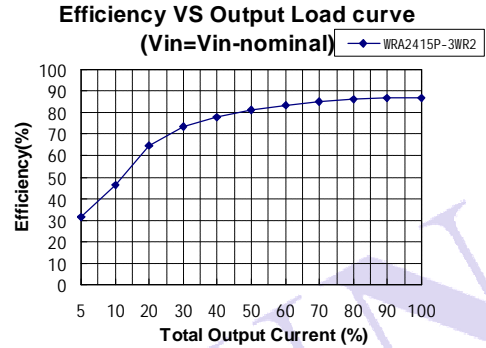
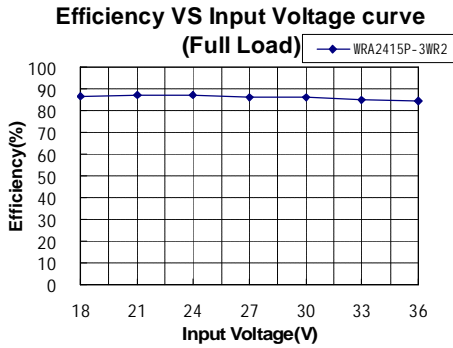
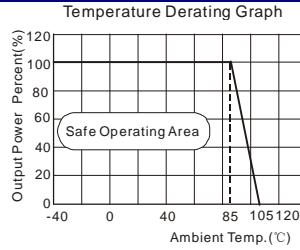

# OUTLINE DIMENSIONS, RECOMMENDED FOOTPRINT & PACKAGING

### MECHANICAL DIMENSIONS

(Front View)

(Bottom View)

Pin	Single	Dual
2,3	GND	GND
9	NC	0V
10,15	NC	NC
11	NC	-Vo
14	+Vo	+Vo
16	0V	0V
22,23	Vin	Vin

NC: No connection

Note:  
Unit:mm[inch]  
Pin diameter tolerances: ± 0.10mm[± 0.004inch]  
General tolerances: ± 0.25mm[± 0.010inch]

### RECOMMENDED FOOTPRINT

Note: grid 2.54\*2.54mm.

### TUBE OUTLINE DIMENSIONS

Note:  
Unit:mm[inch]  
General tolerances: ± 0.50mm[± 0.020inch]  
L=530mm[20.866inch] Devices per tube quantity: 15pcs  
L=220mm[8.661inch] Devices per tube quantity: 6pcs  
Short tube inner package dimensions: L\*W\*H= 255\*170\*90mm  
Short tube outer package dimensions: L\*W\*H= 375\*280\*270mm  
Long tube inner package dimensions: L\*W\*H= 580\*200\*100mm  
Long tube outer package dimensions(with two inner package boxes): L\*W\*H= 600\*215\*220mm  
Long tube outer package dimensions(with three inner package boxes): L\*W\*H= 600\*215\*325mm

## TEST CONFIGURATIONS

### Input Reflected-Ripple Current Test Setup

Input reflected-ripple current is measured with an inductor  $L_{in}$  and Capacitor  $C_{in}$  to simulate source impedance.

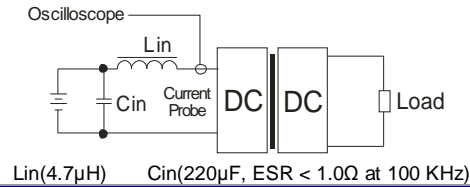

## DESIGN CONSIDERATIONS

### 1) Requirement on output load

To ensure this module can operate efficiently and reliably, During operation, the minimum output load could not be less than 5% of the full load. otherwise ripple maybe increase dramatically. If the actual output power is very small, please connect a resistor with proper resistance at the output end in parallel to increase the load, suppose to use the resistance of 5% rated power, or use our company's products with a lower rated output power.

### 2) Recommended circuit

All the WRA\_P-3WR2 & WRB\_P-3WR2 Series have been tested according to the following recommended testing circuit before leaving factory (see Figure 5).

If you want to further decrease the input/output ripple, you can increase a capacitance properly or choose capacitors with low ESR. However, the capacitance of the output filter capacitor must be proper. If the capacitance is too big, a startup problem might arise. For every channel of output, provided the safe and reliable operation is ensured, the greatest capacitance of its filter capacitor must less than the Max. Capacitive Load.

General:  $C_{in}$ : 5V&12V 100 $\mu$ F  
24V&48V 10 $\mu$ F~47 $\mu$ F  
 $C_{out}$ : 10 $\mu$ F/100mA

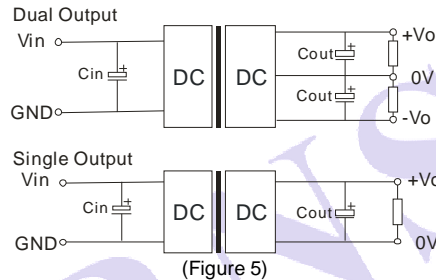

### 3) Input current

When it is used in unregulated power supply, be sure that the fluctuating range of the power supply and the rippled voltage do not exceed the module standard. Input current of power supply should afford the flash startup current of this kind of DC/DC module (Figure 6).

General:  $V_{in}$ :5V  $I_p$  =1400mA  
 $V_{in}$ :12V  $I_p$  =620mA  
 $V_{in}$ :24V  $I_p$  =300mA  
 $V_{in}$ :48V  $I_p$  =150mA

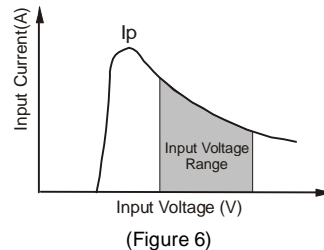

### 4) Cannot use in parallel and hot swap

Note:

1. Min. load shouldn't be less than 5%, otherwise ripple maybe increase dramatically. Operation under minimum load will not damage the converter, however, they may not meet all specification listed.
2. Max. Capacitive Load tested at input voltage range and full load.
3. All specifications measured at  $T_a=25^{\circ}\text{C}$ , humidity<75%, nominal input voltage and rated output load unless otherwise specified.
4. In this datasheet, all the test methods of indications are based on our corporate standards.
5. All characteristics are for listed model, non-standard models may perform differently, please contact our technical person for more detail.
6. Contact us for your specific requirement.
7. Specifications subject to change without prior notice.

## MORNSUN Science & Technology Co.,Ltd.

Address: No. 5, Kehui St. 1, Kehui development center, Science Ave., Guangzhou Science City, Luogang district, Guangzhou,P.R.China.

Tel: 86-20-28203030

Fax:86-20-38601272

[Http://www.mornsun-power.com](http://www.mornsun-power.com)