

20W, wide input isolated & regulated single output, DIP packaging, DC-DC converter

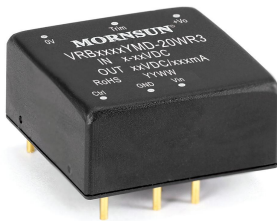

Patent Protection RoHS

### FEATURES

- Wide input voltage range (2:1)
- High efficiency up to 91%
- Isolation voltage : 1.5K VDC
- Input under-voltage protection, output short circuit, over-current, over-voltage protection
- Operating temperature range: -40°C to +105°C
- International standard pin-out
- Meets EN62368 standards(Pending)

VRB\_YMD-20WR3 series are isolated 20W DC-DC products with 2:1 input voltage. They feature efficiency up to 91%, 1500VDC isolation, operating temperature of -40°C to +105°C, input under-voltage protection, output over-voltage, output over-current, output short circuit protection, which make them widely applied in industrial control, electric power, instruments and communication fields.

### Selection Guide

Certification	Part No.	Input Voltage (VDC)		Output		Efficiency <sup>②</sup> (%Min./Typ.) @ Full Load	Max. Capacitiv e Load(μF)
		Nominal (Range)	Max. <sup>①</sup>	Output Voltage (VDC)	Output Current (mA) (Max./Min.)		
CE (Pending)	VRB1203YMD-20WR3	12 (9-18)	20	3.3	5000/0	84/86	10000
	VRB1205YMD-20WR3			5	4000/0	87/89	10000
	VRB1212YMD-20WR3			12	1667/0	87/89	1600
	VRB1215YMD-20WR3			15	1333/0	88/90	1000
	VRB1224YMD-20WR3			24	833/0	88/90	500
	VRB2403YMD-20WR3	24 (18-36)	40	3.3	5000/0	86/88	10000
	VRB2405YMD-20WR3			5	4000/0	88/90	10000
	VRB2412YMD-20WR3			12	1667/0	88/90	1600
	VRB2415YMD-20WR3			15	1333/0	89/91	1000
	VRB2424YMD-20WR3			24	833/0	89/91	500
	VRB4803YMD-20WR3	48 (36-75)	80	3.3	5000/0	86/88	10000
	VRB4805YMD-20WR3			5	4000/0	88/90	10000
	VRB4812YMD-20WR3			12	1667/0	89/91	1600
	VRB4815YMD-20WR3			15	1333/0	89/91	1000
	VRB4824YMD-20WR3			24	833/0	89/91	500

Notes:

① Absolute maximum rating without damage on the converter, but it isn't recommended;

② Efficiency is measured in nominal input voltage and rated output load; A2S (wiring) and A4S (rail) Model due to input reverse polarity protection, minimum efficiency greater than Min.-2 is qualified.

### Input Specifications

Item	Operating Conditions		Min.	Typ.	Max.	Unit
Input Current (full load / no-load)	12VDC nominal input series, nominal input voltage	3.3V output	--	1599/40	1637/70	mA
		5V output	--	1873/45	1916/70	
		12V output	--	1873/7	1916/20	
		15V output	--	1852/7	1894/20	
		24V output	--	1852/12	1894/20	
	24VDC nominal input series, nominal input voltage	3.3V output	--	782/30	800/50	
		5V output	--	926/35	947/55	
		12V output	--	926/6	947/15	
		15V output	--	916/6	937/15	
		24V output	--	916/10	937/20	

Input Current (full load / no-load)	48VDC nominal input series, nominal input voltage	3.3V output	--	391/15	400/30	mA
		5V output	--	463/20	474/30	
		12V output	--	458/3	469/15	
		15V output	--	458/3	469/15	
		24V output	--	458/4	469/15	
Reflected Ripple Current	Nominal input series,	--	30	--		
Surge Voltage (1sec. max.)	12VDC nominal input series	-0.7	--	25		VDC
	24VDC nominal input series	-0.7	--	50		
	48VDC nominal input series	-0.7	--	100		
Starting Voltage	12VDC nominal input series	--	--	9		VDC
	24VDC nominal input series	--	--	18		
	48VDC nominal input series	--	--	36		
Input under-voltage Protection	12VDC nominal input series	5.5	6.5	--		VDC
	24VDC nominal input series	12	15.5	--		
	48VDC nominal input series	26	30	--		
Starting Time	Nominal input voltage & constant resistance load	--	10	--		ms
Input Filter		Pi filter				
Hot Plug		Unavailable				
Ctrl*	Module switch on	Ctrl suspended or connected to TTL high level (3.5-12VDC)				
	Module switch off	Ctrl pin connected to GND or low level (0-1.2VDC)				
	Input current when switched off	--	2	7		mA

Note: \*The voltage of Ctrl pin is relative to input pin GND.

## Output Specifications

Item	Operating Conditions	Min.	Typ.	Max.	Unit	
Output Voltage Accuracy	0%-100% load	--	±1	±3	%	
Line Regulation	Full load, the input voltage is from low voltage to high voltage	--	±0.2	±0.5		
Load Regulation	5%-100% load	--	±0.5	±1		
Transient Recovery Time		--	300	500	μs	
Transient Response Deviation	25% load step change, nominal input voltage	3.3, 5V output	--	±5	±8	%
		Others	--	±3	±5	
Temperature Coefficient	Full load	--	--	±0.03	%/°C	
Ripple & Noise <sup>①</sup>	20MHz bandwidth, 5%-100% load	--	50	100	mV p-p	
Trim	Input voltage range	90	--	110	%Vo	
Output Over-voltage Protection		110	--	160		
Output Over-current Protection		110	150	190	%Io	
Short circuit Protection	Input voltage range	Hiccup, Continuous, self-recovery				

Note: ①0%-5% load ripple&Noise is no more than 5%Vo. Ripple and noise are measured by "parallel cable" method, please see DC-DC Converter Application Notes for specific operation.

## General Specifications

Item	Operating Conditions	Min.	Typ.	Max.	Unit
Insulation Voltage	Input-output, with the test time of 1 minute and the leak current lower than 1mA	1500	--	--	VDC
	Input/output-case with the test time of 1 minute and the leak current lower than 1mA	1000	--	--	
Insulation Resistance	Input-output, insulation voltage 500VDC	1000	--	--	MΩ
Isolation Capacitance	Input-output, 100KHz/0.1V	--	2000	--	pF

Operating Temperature	see Fig. 1	3.3V, 5V output	-40	--	+95	°C
		Others	-40	--	+105	
Storage Temperature			-55	--	+125	
Storage Humidity	Non-condensing		5	--	95	%RH
Lead Temperature	Welding spot is 1.5mm away from the casing, 10 seconds		--	--	+300	°C
Vibration			10-150Hz, 5G, 0.75mm. along X, Y and Z			
Switching Frequency	PWM mode	3.3V, 5V output	--	300	--	KHz
		Others	--	270	--	
MTBF	MIL-HDBK-217F@25°C		1000	--	--	K hours

Note:\*This series of products with reduced frequency technology.The switching frequency of the full test, when the load is light, the switching frequency decline.

### Physical Specifications

Casing Material	Aluminum alloy
Dimension	25.40*25.40*11.70 mm
Weight	15g(Typ.)
Cooling method	Free air convection

### EMC Specifications

EMI	CE	CISPR32/EN55032	CLASS B (see Fig.3-② for recommended circuit)	
	RE	CISPR32/EN55032	CLASS B (see Fig.3-② for recommended circuit)	
EMS	ESD	IEC/EN61000-4-2	Contact ±6KV, Air ±8KV	perf. Criteria B
	RS	IEC/EN61000-4-3	10V/m	perf. Criteria A
	EFT	IEC/EN61000-4-4	±2KV (see Fig.3-① for recommended circuit)	perf. Criteria A
	Surge	IEC/EN61000-4-5	line to line ±2KV (see Fig.3-① for recommended circuit)	perf. Criteria B
	CS	IEC/EN61000-4-6	3 Vr.m.s	perf. Criteria A

### Product Characteristic Curve

VRB12\_YMD-20WR3 series  
Nominal input voltage, 3.3V, 5V output

VRB12\_YMD-20WR3 series  
Nominal input voltage, 12V, 15V, 24V output

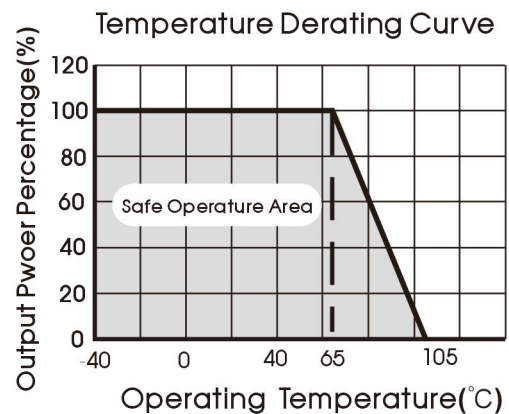
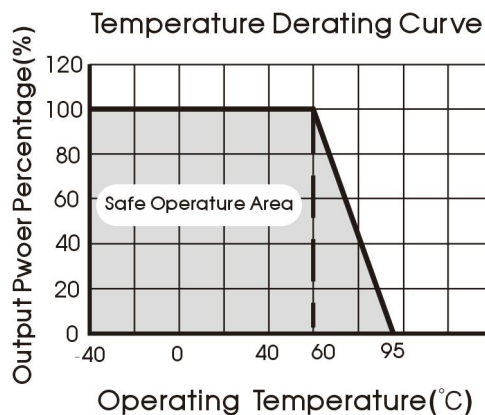

VRB24\_YMD-20WR3/VRB48\_YMD-20WR3 series  
Nominal input voltage, 3.3V, 5V output

VRB24\_YMD-20WR3/VRB48\_YMD-20WR3 series  
Nominal input voltage, 12V, 15V, 24V output

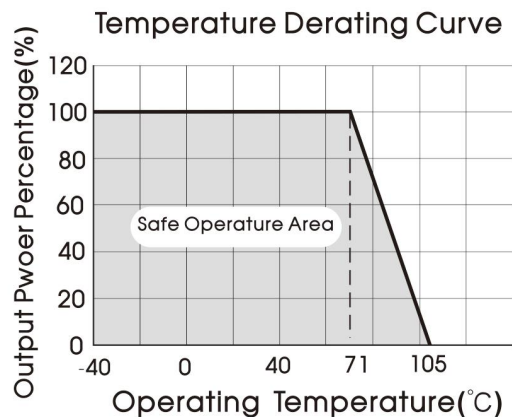
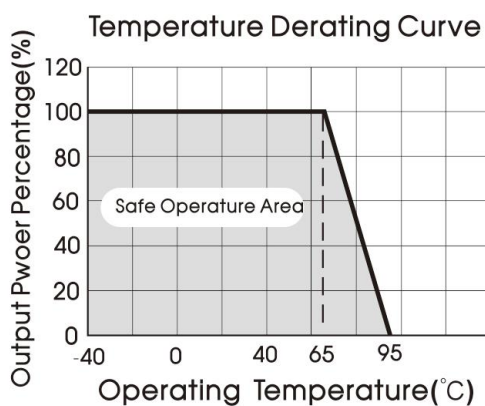
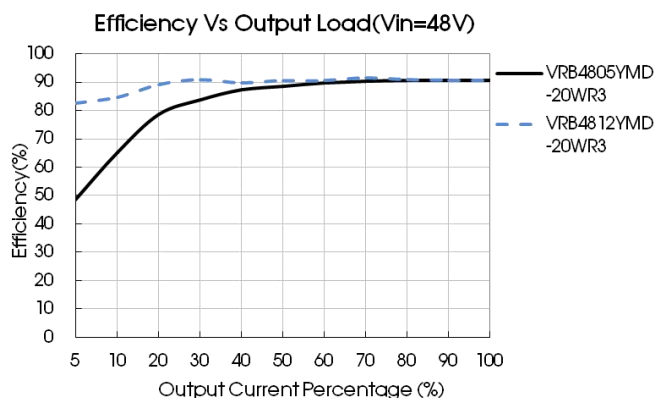
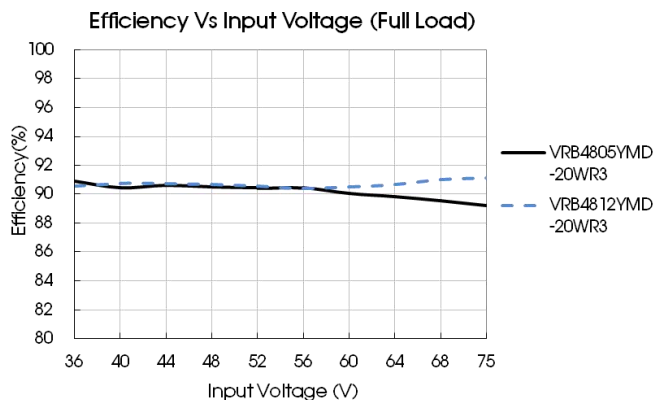
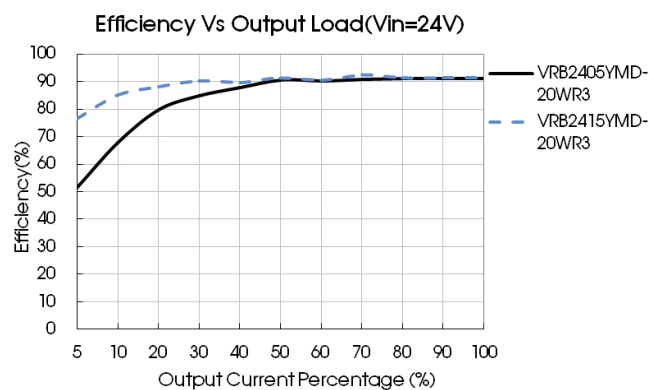
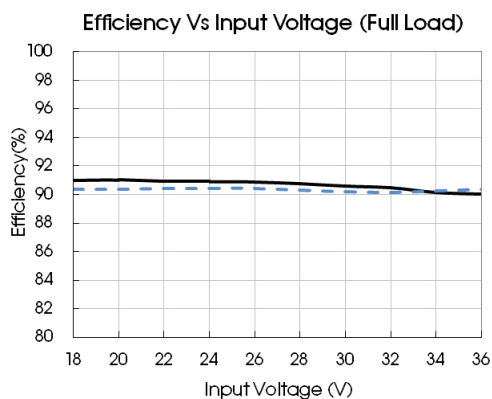
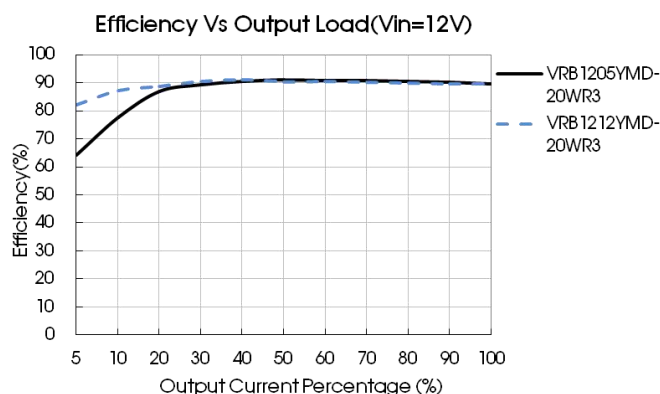
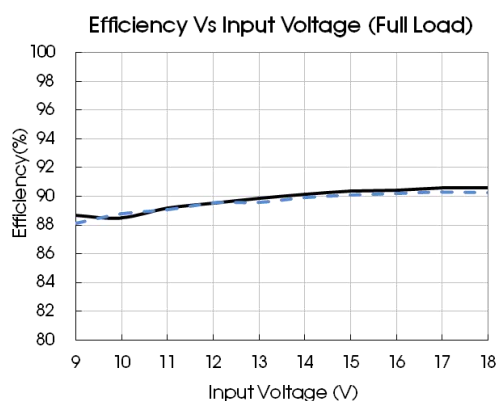

Fig. 1



Design Reference

1. Typical application

All the DC/DC converters of this series are tested according to the recommended circuit (see Fig. 2) before delivery. If it is required to further reduce input and output ripple, properly increase the input & output of additional capacitors Cin and Cout or select capacitors of low equivalent impedance provided that the capacitance is no larger than the max. capacitive load of the product.

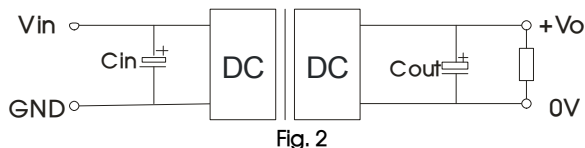

Vout (VDC)	Cin (μF)	Cout (μF)
3.3/5/12/15	100	100
24		47

2. EMC solution-recommended circuit

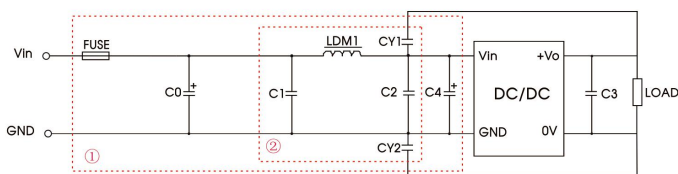

Fig. 3

Notes: Part ① in the Fig. 3 is used for EMC test and part ② for EMI filtering; selected based on needs.

Parameter description:

Model	Vin: 12V, 24V	Vin:48V
FUSE	Choose according to actual input current	
C0, C4	330μF/50V	330μF/100V
C1, C2	4.7μF/50V	4.7μF/100V
C2	Refer to the Cout in Fig.2	
LDM1	2.2μH/4A	2.2μH/2A
CY1/CY2	1nF/2KV	

3. Application of Trim and calculation of Trim resistance

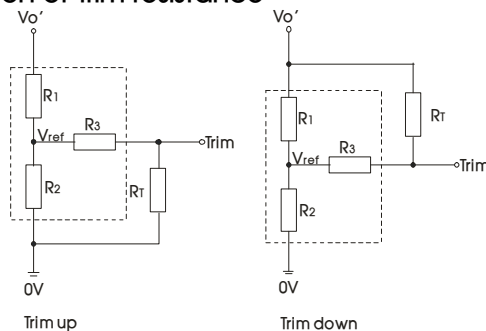

Applied circuits of Trim (Part in broken line is the interior of models)

Calculation formula of Trim resistance:

$$\begin{aligned} \text{up: } R_T &= \frac{\alpha R_2}{R_2 - \alpha} - R_3 & \alpha &= \frac{V_{ref}}{V_{o'} - V_{ref}} \cdot R_1 \\ \text{down: } R_T &= \frac{\alpha R_1}{R_1 - \alpha} - R_3 & \alpha &= \frac{V_{o'} - V_{ref}}{V_{ref}} \cdot R_2 \end{aligned}$$

R<sub>T</sub> is Trim resistance  
α is a self-defined parameter, with no real meaning.

Vout(V)	R1(KΩ)	R2(KΩ)	R3(KΩ)	Vref(V)
3.3	4.829	2.87	15	1.24
5	2.894	2.87	10	2.5
12	11.000	2.87	17.4	2.5
15	14.494	2.87	17.4	2.5
24	24.872	2.87	20	2.5

4. It is not allowed to connect modules output in parallel to enlarge the power

5. For more information please find DC-DC converter application notes on [www.mornsun-power.com](http://www.mornsun-power.com)



Dimensions and Recommended Layout

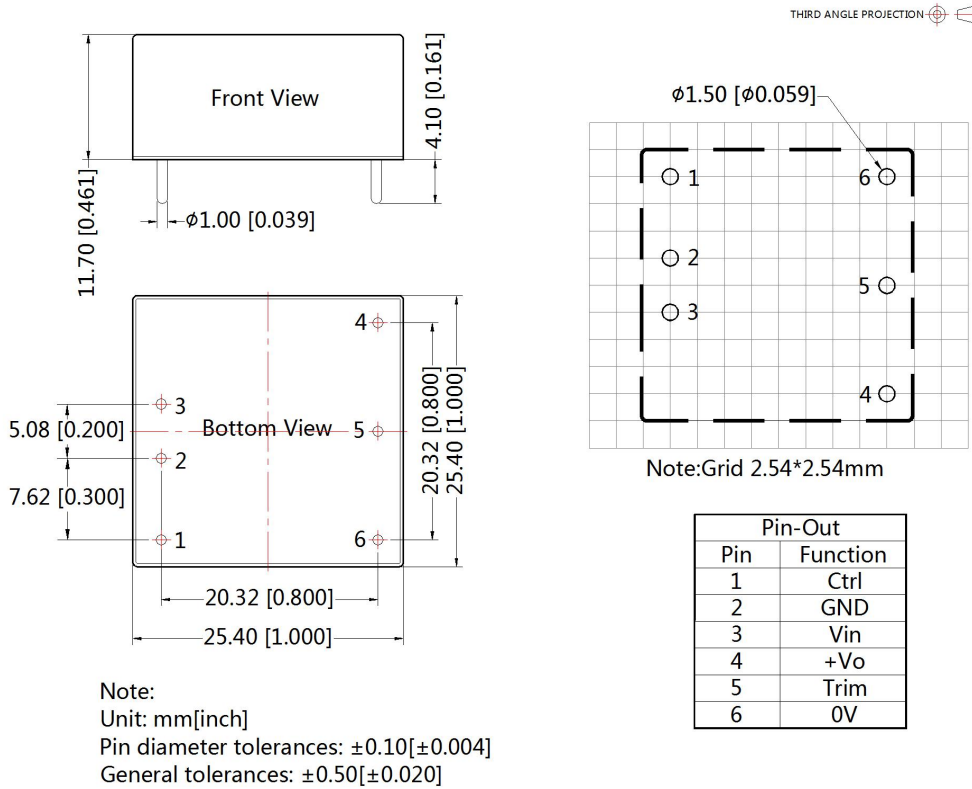

Note:

1. Packing information please refer to Product Packing Information which can be downloaded from [www.mornsun-power.com](http://www.mornsun-power.com). Packing bag number : 58210003 (DIP) ;
2. The maximum capacitive load offered were tested at input voltage range and full load;
3. Unless otherwise specified, parameters in this datasheet were measured under the conditions of  $T_a=25^{\circ}\text{C}$ , humidity<75%RH with nominal input voltage and rated output load;
4. All index testing methods in this datasheet are based on Company's corporate standards;
5. We can provide product customization service, please contact our technicians directly for specific information;
6. Products are related to laws and regulations: see "Features" and "EMC";
7. Our products shall be classified according to ISO14001 and related environmental laws and regulations, and shall be handled by qualified units.

Mornsun Guangzhou Science & Technology Co., Ltd.

Address: No. 5, Kehui St. 1, Kehui Development Center, Science Ave., Guangzhou Science City, Luogang District, Guangzhou, P. R. China  
Tel: 86-20-38601850-8801 Fax: 86-20-38601272 E-mail: [info@mornsun.cn](mailto:info@mornsun.cn)