

DC/DC Converter

VRA_ZP-6WR3 & VRB_ZP-6WR3 Series

MORNSUN®

6W isolated DC-DC converter in DIP package,
Wide input and regulated dual/single output



Patent Protection RoHS



VRA_ZP-6WR3 & VRB_ZP-6WR3 series products are of 6W output power, wide range of voltage input of 4.5-9VDC, 9-18VDC, 18-36VDC, 36-75VDC isolation voltage of 1500VDC, input under-voltage protection, output over-voltage, over-current, short circuit protection and EMI meets CISPR32/EN55032 CLASS A without external components (except for 5VDC input); these products are widely used in fields such as industrial control, electric power, instruments and communication.

FEATURES

- Wide 2:1 input voltage range
- High efficiency up to 88%
- No-load power consumption as low as 0.09W
- I/O isolation test voltage 1.5k VDC
- Operating ambient temperature range: -40°C ~ +85°C
- Meets CISPR32/EN55032 CLASS A, without extra components (except for 5VDC input)
- Input under-voltage protection, output short-circuit, over-current, over-voltage protection
- Industry standard pin-out
- EN62368 approved

Selection Guide

Certification	Part No.	Input Voltage (VDC)		Output		Full Load Efficiency ² (%) Min./Typ.	Max. Capacitive Load ³ (μF)
		Nominal (Range)	Max. ^①	Voltage (VDC)	Current (mA) (Max./Min.)		
CE	VRA0505ZP-6WR3	5 (4.5-9)	12	±5	±600/0	76/78	1000
	VRA0512ZP-6WR3			±12	±250/0	82/84	470
	VRA0515ZP-6WR3			±15	±200/0	82/84	220
	VRA0524ZP-6WR3			±24	±125/0	82/84	100
	VRB0505ZP-6WR3			5	1200/0	76/78	1000
	VRB0512ZP-6WR3			12	500/0	82/84	470
	VRB0515ZP-6WR3			15	400/0	82/84	220
	VRB0524ZP-6WR3			24	250/0	82/84	100
	VRA1205ZP-6WR3			12 (9-18)	20	±5	±600/0
	VRA1212ZP-6WR3	±12	±250/0			82/84	330
	VRA1215ZP-6WR3	±15	±200/0			83/85	220
	VRA1224ZP-6WR3	±24	±125/0			82/84	100
	VRB1203ZP-6WR3	3.3	1500/0			73/75	1800
	VRB1205ZP-6WR3	5	1200/0			78/80	1000
	VRB1212ZP-6WR3	12	500/0			82/84	470
	VRB1215ZP-6WR3	15	400/0			83/85	220
	VRB1224ZP-6WR3	24	250/0			83/85	100
	VRA2405ZP-6WR3	24 (18-36)	40	±5	±600/0	81/83	680
	VRA2412ZP-6WR3			±12	±250/0	84/86	330
	VRA2415ZP-6WR3			±15	±200/0	85/87	220
	VRA2424ZP-6WR3			±24	±125/0	83/85	100
	VRB2403ZP-6WR3			3.3	1500/0	76/78	1800
	VRB2405ZP-6WR3			5	1200/0	80/82	1000
	VRB2412ZP-6WR3			12	500/0	83/85	470
VRB2415ZP-6WR3	15			400/0	84/86	220	
VRB2424ZP-6WR3	24			250/0	84/86	100	

MORNSUN®

MORNSUN GUANGZHOU SCIENCE & TECHNOLOGY CO.,LTD.

2019.02.25-A/3

Page 1 of 6

MORNSUN Guangzhou Science & Technology Co., Ltd. reserves the copyright and right of final interpretation

CE	VRA4805ZP-6WR3	48 (36-75)	80	±5	±600/0	81/83	680
	VRA4812ZP-6WR3			±12	±250/0	85/87	330
	VRA4815ZP-6WR3			±15	±200/0	83/85	220
	VRA4824ZP-6WR3			±24	±125/0	83/85	100
	VRB4803ZP-6WR3			3.3	1500/0	77/79	1800
	VRB4805ZP-6WR3			5	1200/0	81/83	1000
	VRB4812ZP-6WR3			12	500/0	85/87	470
	VRB4815ZP-6WR3			15	400/0	86/88	220
	VRB4824ZP-6WR3			24	250/0	85/87	100

Notes:

- ① Exceeding the maximum input voltage may cause permanent damage;
- ② Efficiency is measured in nominal input voltage and rated output load;
- ③ The specified maximum capacitive load for positive and negative output is identical.

Input Specifications

Item	Operating Conditions		Min.	Typ.	Max.	Unit
Input Current (full load / no-load)	5VDC input	5V / ±5V output	--	1538/10	1578/30	mA
		Others	--	1428/10	1463/30	
	12VDC input	3.3V output	--	550/7	566/25	
		Others	--	607/7	641/25	
	24VDC input	3.3V output	--	265/7	272/25	
		Others	--	296/7	313/25	
	48VDC input	3.3V output	--	131/7	134/25	
		Others	--	147/7	155/25	
Reflected Ripple Current	5VDC input		--	50	--	
	Others		--	20	--	
Surge Voltage (1sec. max.)	5VDC input		-0.7	--	16	VDC
	12VDC input		-0.7	--	25	
	24VDC input		-0.7	--	50	
	48VDC input		-0.7	--	100	
Start-up Voltage	5VDC input		--	--	4.5	VDC
	12VDC input		--	--	9	
	24VDC input		--	--	18	
	48VDC input		--	--	36	
Under-voltage Protection	5VDC input		3	3.5	--	
	12VDC input		5.5	6.5	--	
	24VDC input		13	15	--	
	48VDC input		26	30	--	
Input Filter			Pi filter			
Hot Plug			Unavailable			

Output Specifications

Item	Operating Conditions		Min.	Typ.	Max.	Unit
Voltage Accuracy	5VDC input, 0%-100% load ^①	Positive output	--	±1	±2	%
		Negative output	--	±1	±3	
	Others	Positive output	--	±1	±3	
		Negative output	--	±1	±3	
Linear Regulation	Input voltage variation from low to high at full load	Positive output	--	±0.2	±0.5	
		Negative output	--	±0.5	±1	
Load Regulation ^②	5VDC input, 0%-100% load	Positive output	--	--	±1	
		Negative output	--	--	±1.5	

Load Regulation ^①	other input, 5%-100% load ^②	Positive output	--	±0.5	±1	%
		Negative output	--	±0.5	±1.5	
Cross Regulation	Dual output, main circuit with 50% load, auxiliary circuit with 10%-100% load		--	--	±5	
Transient Recovery Time			--	300	500	μs
Transient Response Deviation	25% load step change, Nominal input voltage	3.3V/5V/±5V output	--	±5	±8	%
		Others	--	±3	±5	
Temperature Coefficient	Full load		--	--	±0.03	%/°C
Ripple & Noise ^③	20MHz bandwidth, 5%-100% load		--	--	100	mV p-p
Over-voltage Protection			110	--	160	%Vo
Over-current Protection	Input voltage range		110	140	190	%Io
Short-circuit Protection			Continuous, self-recovery			

Note: ① At 0%~5% load, the Max. output voltage accuracy of ±5VDC output converter is ±5%;
 ② When testing from 0% to 100% load working conditions, load regulation index of ±5%;
 ③ Ripple & Noise at < 5% load is 5%Vo max. The "parallel cable" method is used for Ripple and Noise test, please refer to DC-DC Converter Application Notes for specific information.

General Specifications

Item	Operating Conditions	Min.	Typ.	Max.	Unit
Isolation	Input-output Electric Strength Test for 1 minute with a leakage current of 1mA max.	1500	--	--	VDC
	Input/output-case Electric Strength Test for 1 minute with a leakage current of 1mA max.	1500	--	--	
Insulation Resistance	Input-output resistance at 500VDC	1000	--	--	MΩ
Isolation Capacitance	Input-output capacitance at 100KHz/0.1V	--	1000	--	pF
Operating Temperature	See Fig. 1	-40	--	85	°C
Storage Temperature		-55	--	+125	
Storage Humidity	Non-condensing	5	--	95	%RH
Pin Soldering Resistance Temperature	Soldering spot is 1.5mm away from case for 10 seconds	--	--	300	°C
Vibration		10-150Hz, 5G, 30 Min. along X, Y and Z			
Switching Frequency *	PWM mode	--	300	--	KHz
MTBF	MIL-HDBK-217F@25°C	1000	--	--	K hours

Note: * Switching frequency is measured at full load. The module reduces the switching frequency for light load (below 50%) efficiency improvement.

Mechanical Specifications

Case Material	Aluminum alloy	
Dimensions	32.00 × 20.00 × 10.80mm	
Weight	5VDC input	12.0g(Typ.)
	Others	14.0g(Typ.)
Cooling Method	Free air convection	

Electromagnetic Compatibility (EMC)

Emissions	CE	5VDC input	CISPR32/EN55032 CLASS B (see Fig.3-② for recommended circuit)		
		Others	CISPR32/EN55032 CLASS A (without external components)/ CLASS B (see Fig.4-② for recommended circuit)		
	RE	5VDC input	CISPR32/EN55032 CLASS B (see Fig.3-② for recommended circuit)		
		Others	CISPR32/EN55032 CLASS A (without external components)/ CLASS B (see Fig.4-② for recommended circuit)		
Immunity	ESD		IEC/EN61000-4-2	Contact ±4KV	perf. Criteria B
	RS		IEC/EN61000-4-3	10V/m	perf. Criteria A
	EFT	5VDC input	IEC/EN61000-4-4	±2KV (see Fig.3-① for recommended circuit)	perf. Criteria B
		Others	IEC/EN61000-4-4	±2KV (see Fig.4-① for recommended circuit)	perf. Criteria B

	Surge	5VDC input	IEC/EN61000-4-5	line to line ± 2 KV (see Fig.3-① for recommended circuit)	perf. Criteria B
		Others	IEC/EN61000-4-5	line to line ± 2 KV (see Fig.4-① for recommended circuit)	perf. Criteria B
	CS		IEC/EN61000-4-6	3 Vr.m.s	perf. Criteria A

Typical Characteristic Curves

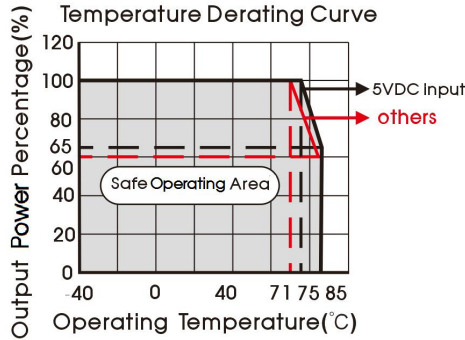
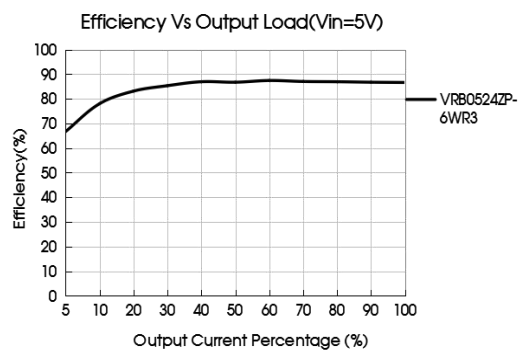
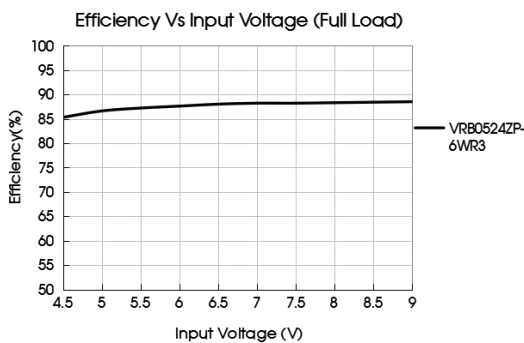
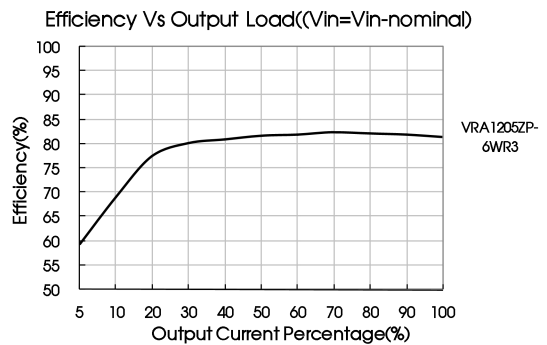
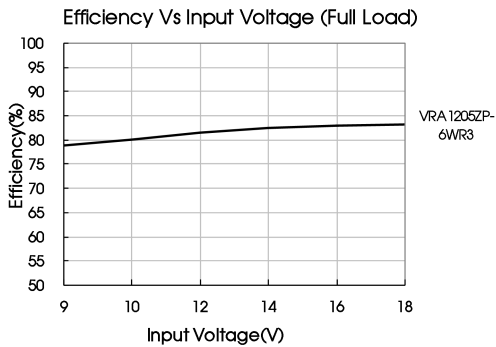
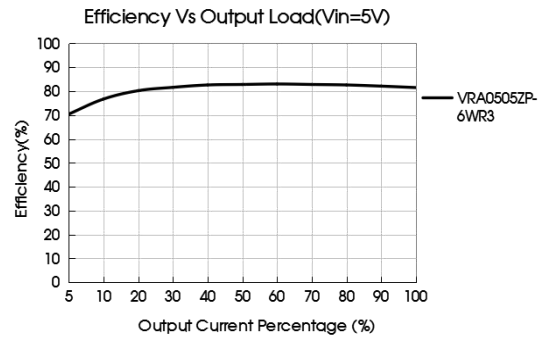
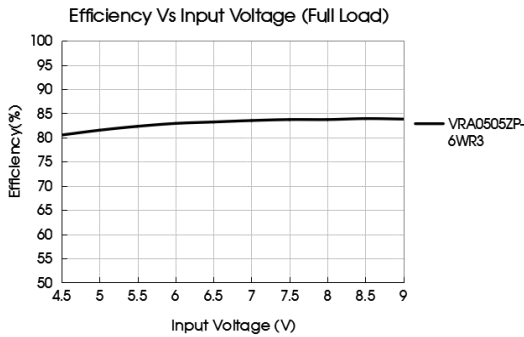
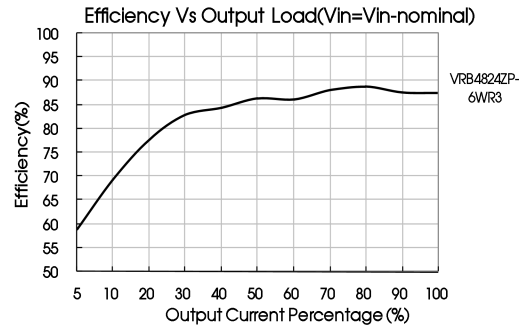
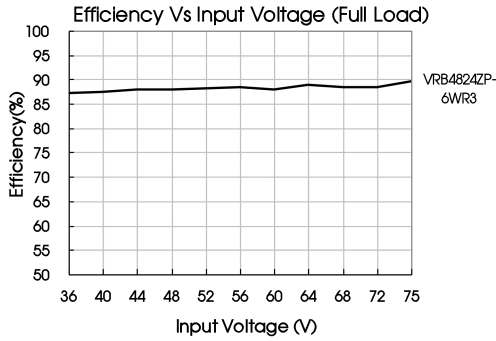

Fig. 1





Design Reference

1. Typical application

All the DC/DC converters of this series are tested according to the recommended circuit (see Fig. 2) before delivery. If it is required to further reduce input and output ripple, properly increase the input & output of additional capacitors Cin and Cout or select capacitors of low equivalent impedance provided that the capacitance is no larger than the max. capacitive load of the product.

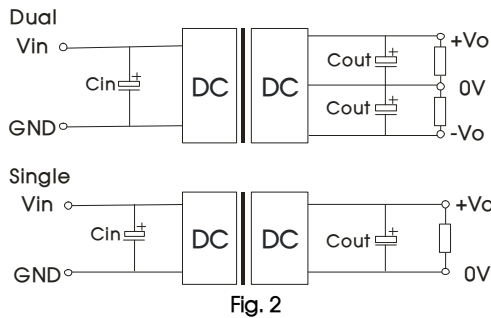

Vin(VDC)	Cin	Cout
5/12/24	100µF	10µF
48	10µF - 47µF	

2. EMC compliance circuit

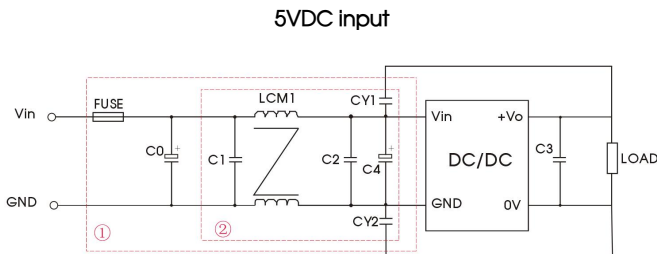

Fig. 3

Notes: For EMC tests we use Part ① in Fig. 3 for immunity and part ② for emissions test. Selecting based on needs.

Parameter description:

Model	Vin: 5V
FUSE	Select fuse value according to actual input current
C0	2200µF/35V
C1/C2	4.7µF/50V
C3	Refer to the Cout in Fig.2
C4	100µF/35V
LCM1	2.2mH, recommended to use MORNSUN's FL2D-30-222
CY1, CY2	2.2nF/2KV

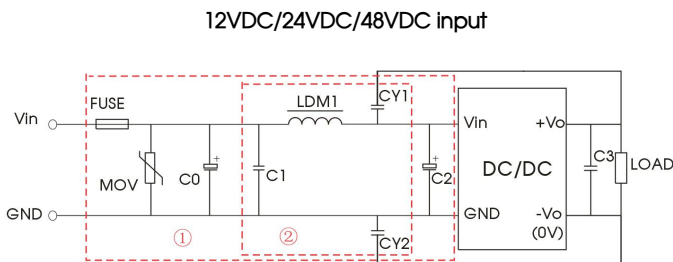

Fig. 4

Notes: For EMC tests we use Part ① in Fig. 4 for immunity and part ② for emissions test. Selecting based on needs.

Parameter description:

Model	Vin:12V	Vin:24V	Vin:48V
FUSE	Select fuse value according to actual input current		
MOV	S14K20	S20K30	S14K60
C0	1000µF/35V	1000µF/50V	680µF/100V
C2	100µF/35V	100µF/50V	100µF/100V
C1	1µF/50V		1µF/100V
C3	Refer to the Cout in Fig.2		
LDM1	4.7µH		
CY1, CY2	1nF/2KV		

- The products do not support parallel connection of their output
- For additional information please refer to DC-DC converter application notes on www.mornsun-power.com

Dimensions and Recommended Layout

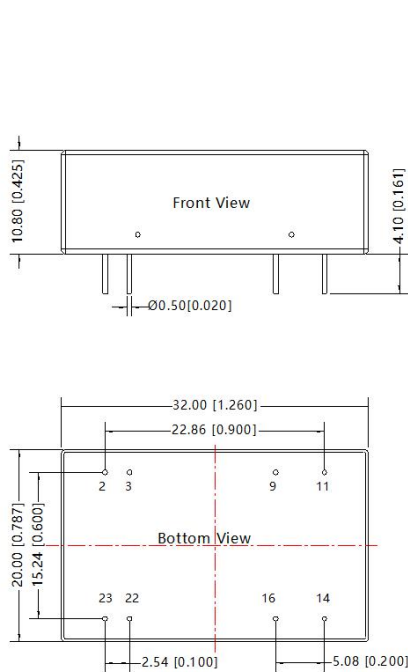

Note:
 Unit :mm [inch]
 Pin diameter tolerances :± 0.10 [± 0.004]
 General tolerances:± 0.50 [± 0.020]

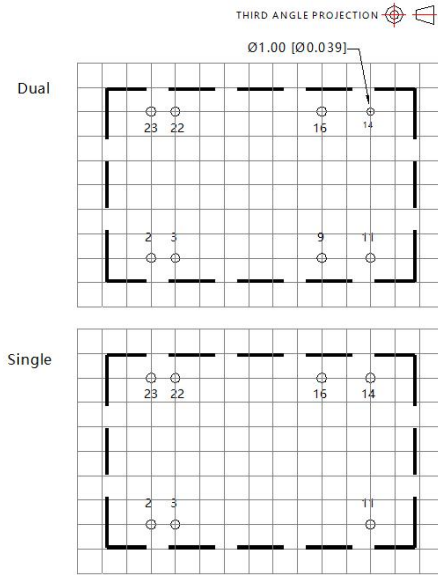

Note:Grid 2.54*2.54mm

Pin-Out		
Pin	Single	Dual
2,3	GND	GND
9*	No Pin	0V
11	NC	-Vo
14	+Vo	+Vo
16	0V	0V
22,23	Vin	Vin

* Note: 5V input product without 9th pin
 NC: Pin to be isolated from circuit

Notes:

- For additional information on Product Packaging please refer to www.mornsun-power.com. Packaging bag number : 58210008;
- The maximum capacitive load offered were tested at input voltage range and full load;
- Unless otherwise specified, parameters in this datasheet were measured under the conditions of Ta=25°C, humidity<75%RH with nominal input voltage and rated output load;
- All index testing methods in this datasheet are based on company corporate standards;
- We can provide product customization service, please contact our technicians directly for specific information;
- Products are related to laws and regulations: see "Features" and "EMC";
- Our products shall be classified according to ISO14001 and related environmental laws and regulations, and shall be handled by qualified units.

Mornsun Guangzhou Science & Technology Co., Ltd.

Address: No. 5, Kehui St. 1, Kehui Development Center, Science Ave., Guangzhou Science City, Huangpu District, Guangzhou, P. R. China
 Tel: 86-20-38601850 Fax: 86-20-38601272 E-mail: info@mornsun.cn www.mornsun-power.com