

# MORNSUN®

## URA\_(X)D-10WR2& URB\_(X)D-10WR2 Series 10W, ULTRA-WIDE INPUT ISOLATED& REGULATED DUAL/SINGLE OUTPUT DIP PACKAGING, DC-DC CONVERTER



Patent Protection RoHS

### PART NUMBER SYSTEM

URB2405(X)D-10WR2

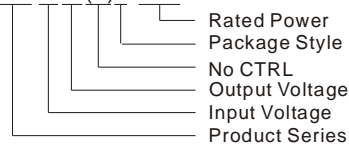

### FEATURES

- 4:1 wide input voltage range
- Efficiency up to 87%
- 1.5KVDC isolation
- Short circuit protection
- Output over voltage protection
- Output over current protection
- Operating Temperature range: -40°C ~ +85°C
- Industry standard pinout
- Low ripple & noise
- Meet CISPR22/EN55022 CLASS A

### APPLICATION

The URA\_(X)D-10WR2&URB\_(X)D-10WR2 series offer 10W of output, with 4:1 wide input voltage of 9-36VDC, 18-75VDC and features 1500VDC isolation, output over voltage and short-circuit protection. The products meet CISPR22/EN55022 CLASS A. All models are particularly suited to industrial control, electric power, instrumentation, tele-communications etc.

### SELECTION GUIDE

Model Number	Input Voltage(VDC)		Output Voltage (VDC)	Output Current (mA)		Input Current (mA)(typ.)		Reflected Ripple Current (mA,typ.)	Max. Capacitive Load(μF)	Efficiency (%. typ.) @Max. Load
	Nominal (Range)	Max**		Max.	Min.	@Max. Load	@No Load			
*URA2405(X)D-10WR2	24 (9-36)	40	±5	±1000	±50	508	12	40	680	82
*URA2412(X)D-10WR2			±12	±416	±21	484			220	86
*URA2415(X)D-10WR2			±15	±333	±16	479			100	87
URB2403(X)D-10WR2			3.3	2400	120	527			2200	79
URB2405(X)D-10WR2			5	2000	100	508			2200	82
URB2412(X)D-10WR2			12	833	42	484			470	86
URB2415(X)D-10WR2			15	667	33	479			330	87
*URB2424(X)D-10WR2			24	416	21	479			100	87
URA4805(X)D-10WR2	48 (18-75)	80	±5	±1000	±50	254	6	30	680	82
*URA4812(X)D-10WR2			±12	±416	±21	242			150	86
*URA4815(X)D-10WR2			±15	±333	±16	239			100	87
*URB4803(X)D-10WR2			3.3	2400	120	271			2200	77
URB4805(X)D-10WR2			5	2000	100	254			2200	82
URB4812(X)D-10WR2			12	833	42	242			330	86
URB4815(X)D-10WR2			15	667	33	239			220	87
*URB4824(X)D-10WR2			24	416	21	239			100	87

Note: 1.\*designing.  
2.\*\*Input voltage can't exceed this value, or will cause the permanent damage.  
3."X" means the model without CTRL pin.

### INPUT SPECIFICATIONS

Item	Test Conditions	Min.	Typ.	Max.	Unit
Input Surge Voltage (1sec. max.)	24VDC input	-0.7	--	50	VDC
	48VDC input	-0.7	--	100	
Start-up Voltage	24VDC input	--	--	9	
	48VDC input	--	--	18	

No-load Input Power		--	0.3	0.5	W
Input Filter		π Filter			
Ctrl *	Models ON	Ctrl open or connect TTL high level (3.5-12VDC)			
	Models OFF	Ctrl connect GND or low level (0-1.2VDC)			
	Input current (Models OFF)	--	1	3	mA
Note: *The Ctrl pin voltage is referenced to GND.					

## OUTPUT SPECIFICATIONS

Item	Test Conditions	Min.	Typ.	Max.	Unit
Output Power		0.5	--	10	W
Output Voltage Accuracy		--	±1	±2	%
Output Voltage Balance	Dual output, balanced Loads	--	±0.5	±1.5	
Line Regulation	Full load, Input voltage from low to high	--	±0.2	±0.5	
Load Regulation	5% to 100% load	--	±0.5	±1	
Cross Regulation	Dual output, main output 50% load, Supplement output from 10% to 100% load	--	--	±5	
Transient Recovery Time	25% load step change	--	300	500	μs
Transient Response Deviation		--	±3	±5	%
Temperature Drift	100% load	--	--	±0.03	%/°C
Ripple*	20MHz bandwidth	--	15	35	mVp-p
Noise*		--	40	80	
Output Over Voltage Protection	Input voltage range	110	120	140	%Vo
Over Current Protection		120	150	180	%Io
Output Short Circuit Protection		Continuous, automatic recovery			
Note: Dual output models unbalanced load: ±5%.					
* Ripple and noise tested by "parallel cable" method. See detailed operation instructions at Testing of Power Converter section, application notes.					

## COMMON SPECIFICATIONS

Item	Test Conditions	Min.	Typ.	Max.	Unit
Isolation Voltage	Tested for 1 minute and leakage current less than 1 mA	1500	--	--	VDC
Isolation Resistance	Test at 500VDC	1000	--	--	MΩ
Isolation Capacitance	Input/Output, 100KHz/0.1V	--	1000	--	pF
Switching Frequency	PWM mode	--	350	--	KHz
MTBF	MIL-HDBK-217F @25°C	1000	--	--	K hours
Case Material		Aluminum Alloy			
Weight		--	22	--	g

## ENVIRONMENTAL SPECIFICATIONS

Item	Test Conditions	Min.	Typ.	Max.	Unit
Storage Humidity	Non condensing	5	--	95	%
Operating Temperature	Power derating (above 71°C)	-40	--	85	°C
Storage Temperature		-55	--	125	
The Max. Case Temperature	Operating Temperature curve range	--	--	105	
Lead Temperature	1.5mm from case for 10 seconds	--	--	300	
Cooling		Free air convection			
Shake		10-55Hz, 10G, 30 Min. along X, Y and Z			

## EMC SPECIFICATIONS

EMI	CE	CISPR22/EN55022 CLASS A (Without External Circuit) / CLASS B (External Circuit Refer to Figure1-② or Figure 3)
	RE	CISPR22/EN55022 CLASS A (Without External Circuit) / CLASS B (External Circuit Refer to Figure1-② or Figure 3)

EMS	ESD	IEC/EN61000-4-2	Contact ±4KV	perf. Criteria B
	RS	IEC/EN61000-4-3	10V/m	perf. Criteria A
	EFT	IEC/EN61000-4-4	±2KV	perf. Criteria B (External Circuit Refer to Figure1-①)
		IEC/EN61000-4-4	±4KV	perf. Criteria B (External Circuit Refer to Figure 3)
	Surge	IEC/EN61000-4-5	±2KV	perf. Criteria B (External Circuit Refer to Figure1-①or Figure 3)
	CS	IEC/EN61000-4-6	3 Vr.m.s	perf. Criteria A
Voltage dips, short and interruptions immunity		IEC/EN61000-4-29	0%-70%	perf. Criteria B

## EMC RECOMMENDED CIRCUIT

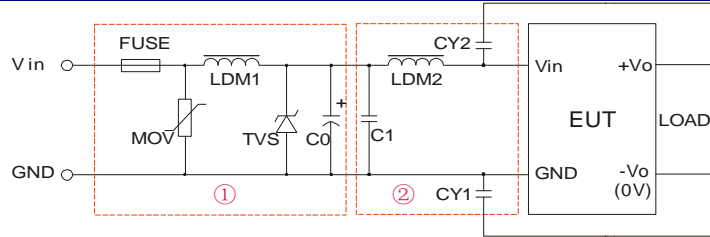

(Figure1)

Recommended external circuit parameters:

Model	URA24_(X)D-10WR2 URB24_(X)D-10WR2	URA48_(X)D-10WR2 URB48_(X)D-10WR2
FUSE	Choose according to practical input current	
MOV	10D560K	10D101K
LDM1	56μH	
TVS	SMCJ48A	SMCJ90A
C0	120μF/50V	120μF/100V
C1	225K/50V	225K/100V
LDM2	4.7μH	
CY1	102K/2000V	
CY2	102K/2000V	

Note: In Figure 1, part① is EMS Recommended external circuit, part② is EMI recommended external circuit. Choose according to requirements.

## EMC RECOMMENDED CIRCUIT PCB LAYOUT

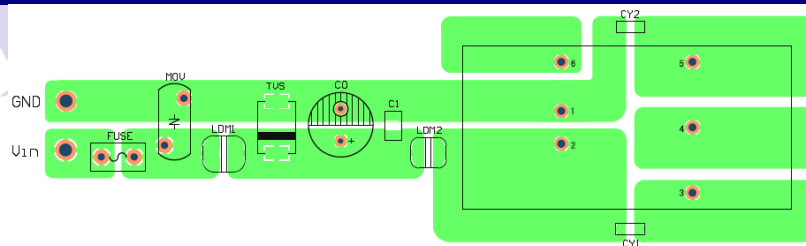

(Figure 2)

## EMC MODULE APPLICATION CIRCUIT

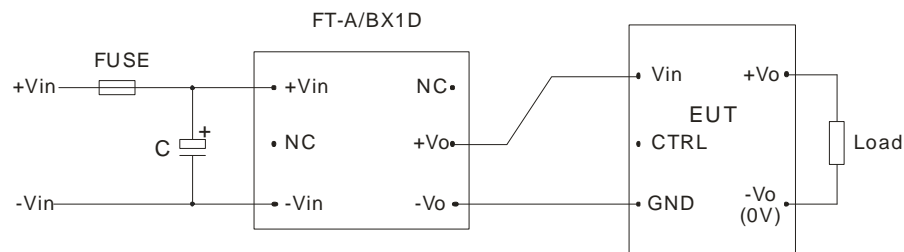

When nominal voltage <48V,  $C \geq 330\mu\text{F}/50\text{V}$

When nominal voltage =48V,  $C \geq 330\mu\text{F}/100\text{V}$

(Figure 3)

# EMC MODULE RECOMMENDED CIRCUIT PCB LAYOUT

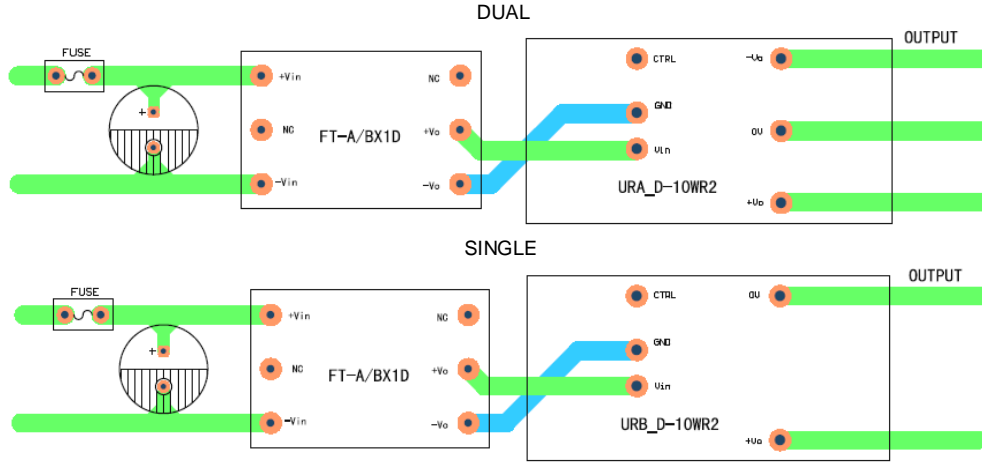

(Figure 4)

## EMI TEST WAVEFORM (FULL LOAD)

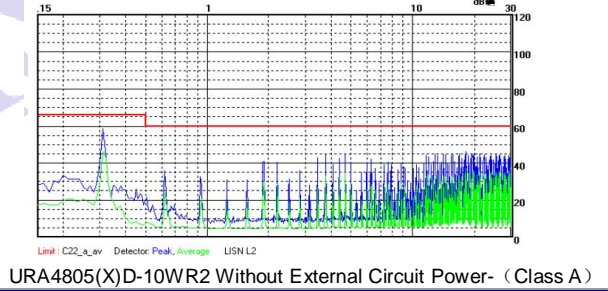
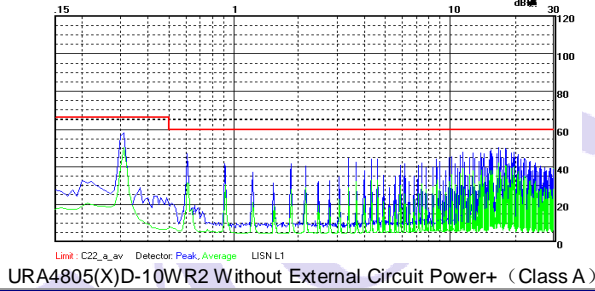
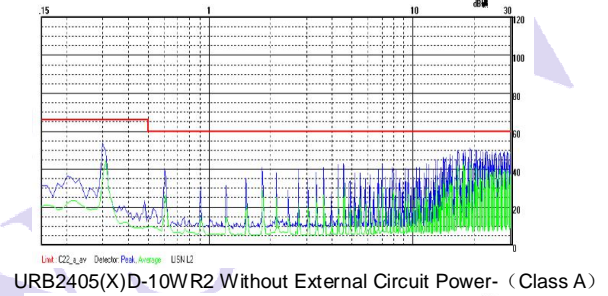
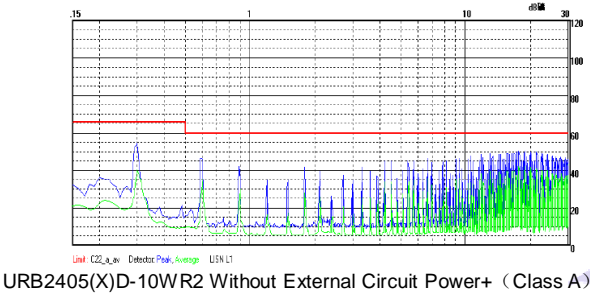

## PRODUCT TYPICAL CURVE

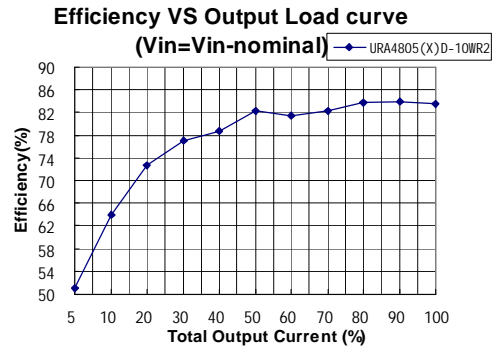
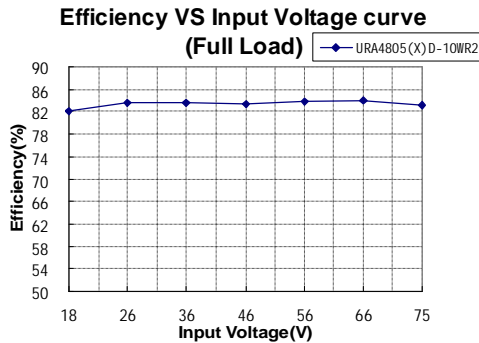
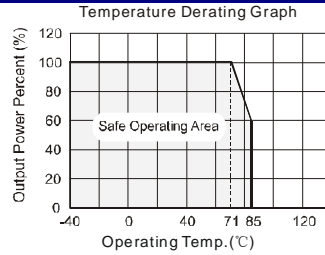

**Efficiency VS Input Voltage curve  
(Full Load)**

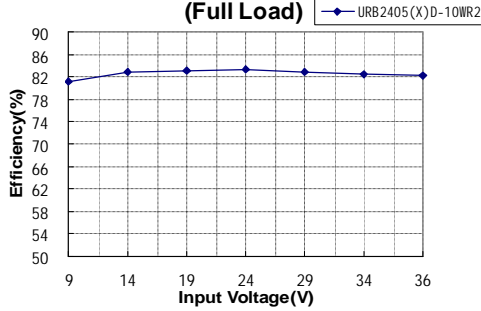

**Efficiency VS Output Load curve  
(Vin=Vin-nominal)**

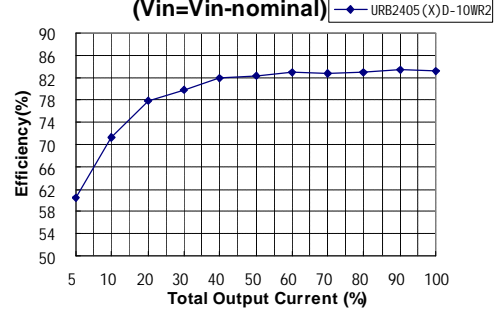

**OUTLINE DIMENSIONS, RECOMMENDED FOOTPRINT & PACKAGING**

**MECHANICAL DIMENSIONS**

FOOTPRINT DETAILS		
Pin	Single	Dual
1	GND	GND
2	Vin	Vin
3	+Vo	+Vo
4	No Pin	0V
5	0V	-Vo
6*	CTRL	CTRL

\*URA/B\_XD-10WR2 series without this pin.

Note:  
 Unit:mm[inch]  
 Pin diameter tolerances: ±0.10mm[±0.004inch]  
 Pin height tolerances: ±0.50mm[±0.020inch]  
 General tolerances: ±0.30mm[±0.012inch]

**RECOMMENDED FOOTPRINT**

Note: grid 2.54\*2.54mm.

**TUBE OUTLINE DIMENSIONS**

Unit :mm[inch]  
 General tolerances: ±0.50mm[±0.020inch]  
 L=220mm[8.661inch] Pcs/Tube:7  
 Inner package dimensions: L\*W\*H= 255\*170\*80mm  
 Outer package dimensions(with six inner packaging boxes):  
 L\*W\*H= 375\*280\*270mm

**TEST CONFIGURATIONS**

**Input Reflected-Ripple Current Test Setup**

Input reflected-ripple current is measured with an inductor Lin and Capacitor Cin to simulate source impedance.

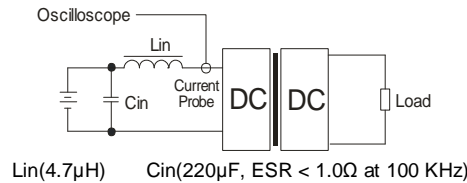

**DESIGN CONSIDERATIONS**

**1) Recommended circuit**

All the URA\_(X)D-10WR2 & URB\_(X)D-10WR2 Series have been tested according to the following recommended testing circuit before leaving factory (see Figure 5).

If you want to further decrease the input/output ripple, you can increase a capacitance properly or choose capacitors with low ESR, but the greatest capacitance of its filter capacitor must less than the Max. Capacitive Load.

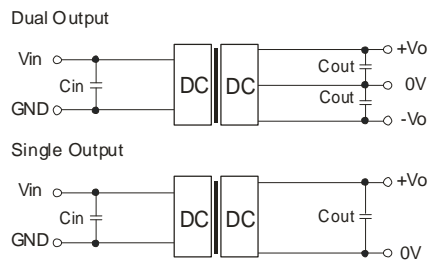

(Figure 5)

## 2) Cannot use in parallel and hot swap

### Note:

1. Min. load shouldn't be less than 5%, otherwise ripple maybe increase dramatically. Operation under minimum load will not damage the converter, however, they may not meet all specification listed.
2. Max. Capacitive Load tested at input voltage range and full load.
3. All specifications measured at  $T_a=25^{\circ}\text{C}$ , humidity<75%, nominal input voltage and rated output load unless otherwise specified.
4. In this datasheet, all the test methods of indications are based on our corporate standards.
5. All characteristics are for listed model, non-standard models may perform differently, please contact our technical person for more detail.
6. Contact us for your specific requirement.
7. Specifications subject to change without prior notice.

### **MORNSUN Science & Technology Co.,Ltd.**

Address: No. 5, Kehui St. 1, Kehui development center, Science Ave., Guangzhou Science City, Luogang district, Guangzhou,P.R.China.

Tel: 86-20-28203030

Fax:86-20-38601272

[Http://www.mornsun-power.com](http://www.mornsun-power.com)