

uA9636AC DUAL LINE DRIVER WITH ADJUSTABLE SLEW RATE

SLLS110B – OCTOBER 1980 – REVISED MAY 1995

- Meets or Exceeds the Requirements of ANSI Standards EIA/TIA-423-B and -232-E and ITU Recommendations V.10 and V.28
- Output Slew Rate Control
- Output Short-Circuit-Current Limiting
- Wide Supply Voltage Range
- 8-Pin Package
- Designed to Be Interchangeable With National DS9636A

D OR P PACKAGE
(TOP VIEW)

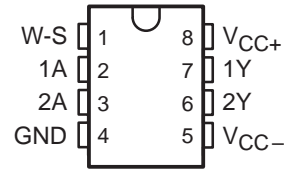

description

The uA9636AC is a dual, single-ended line driver designed to meet ANSI Standards EIA/TIA-423-B and EIA/TIA-232-E and ITU Recommendations V.10 and V.28. The slew rates of both amplifiers are controlled by a single external resistor, $R_{(WS)}$, connected between the wave-shape-control (W-S) terminal and GND. Output current limiting is provided. Inputs are compatible with TTL and CMOS and are diode protected against negative transients. This device operates from ± 12 V and is supplied in an 8-pin package.

The uA9636AC is characterized for operation from 0°C to 70°C.

logic symbol†

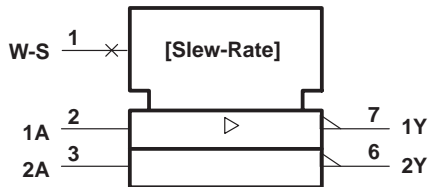

† This symbol is in accordance with ANSI/IEEE Std 91-1984 and IEC Publication 617-12.

logic diagram

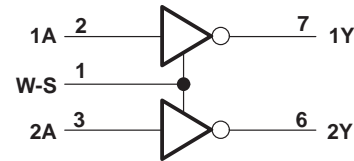

Please be aware that an important notice concerning availability, standard warranty, and use in critical applications of Texas Instruments semiconductor products and disclaimers thereto appears at the end of this data sheet.

PRODUCTION DATA information is current as of publication date. Products conform to specifications per the terms of Texas Instruments standard warranty. Production processing does not necessarily include testing of all parameters.

**TEXAS
INSTRUMENTS**

POST OFFICE BOX 655303 • DALLAS, TEXAS 75265

Copyright © 1995, Texas Instruments Incorporated

uA9636AC DUAL LINE DRIVER WITH ADJUSTABLE SLEW RATE

SLLS110B – OCTOBER 1980 – REVISED MAY 1995

schematics of inputs and outputs

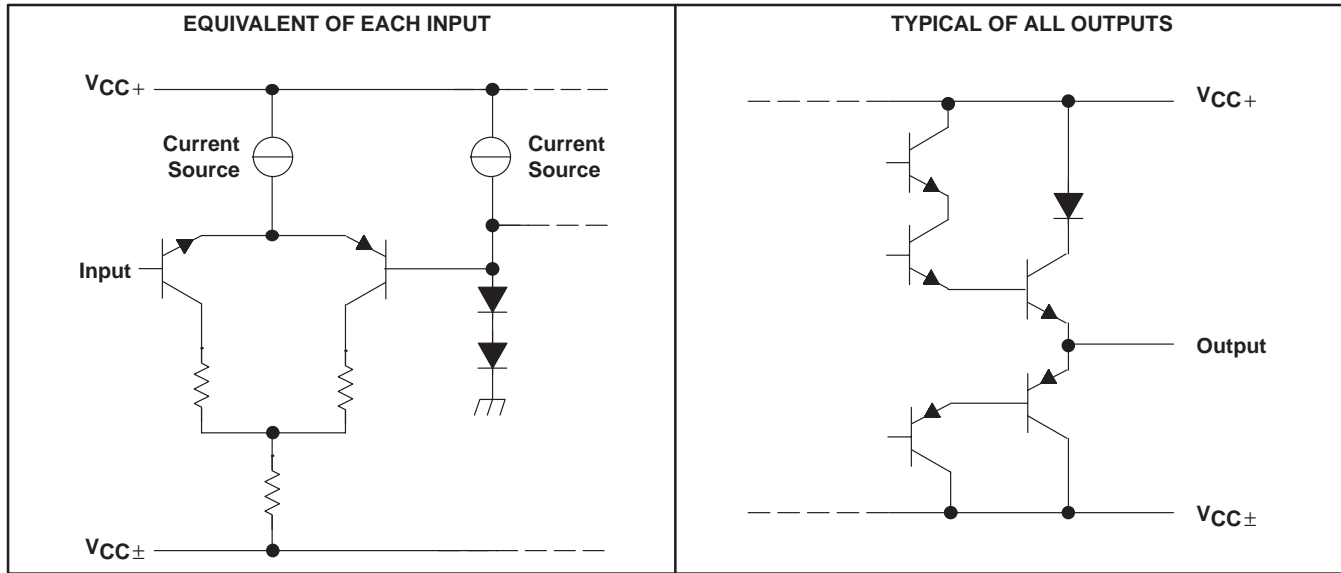

absolute maximum ratings over operating free-air temperature range (unless otherwise noted)†

Positive supply voltage range, V_{CC+} (see Note 1)	V_{CC-} to 15 V
Negative supply voltage range, V_{CC-}	0.5 V to -15 V
Output voltage, V_O	± 15 V
Output current, I_O	± 150 mA
Continuous total power dissipation	See Dissipation Rating Table
Operating free-air temperature range, T_A	0°C to 70°C
Storage temperature range, T_{stg}	-65°C to 150°C
Lead temperature 1,6 mm (1/16 inch) from case for 10 seconds	260°C

† Stresses beyond those listed under "absolute maximum ratings" may cause permanent damage to the device. These are stress ratings only, and functional operation of the device at these or any other conditions beyond those indicated under "recommended operating conditions" is not implied. Exposure to absolute-maximum-rated conditions for extended periods may affect device reliability.

NOTE 1: All voltage values are with respect to the network ground terminal.

DISSIPATION RATING TABLE

PACKAGE	$T_A \leq 25^\circ\text{C}$ POWER RATING	DERATING FACTOR ABOVE $T_A = 25^\circ\text{C}$	$T_A = 70^\circ\text{C}$ POWER RATING
D	725 mW	5.8 mW/°C	464 mW
P	1000 mW	8.0 mW/°C	640 mW

recommended operating conditions

	MIN	NOM	MAX	UNIT
Positive supply voltage, V_{CC+}	10.8	12	13.2	V
Negative supply voltage, V_{CC-}	-10.8	-12	-13.2	V
High-level input voltage, V_{IH}	2			V
Low-level input voltage, V_{IL}			0.8	V
Wave-shaping resistor, $R_{(WS)}$	10		1000	k Ω
Operating free-air temperature, T_A	0		70	°C



POST OFFICE BOX 655303 • DALLAS, TEXAS 75265

uA9636AC

DUAL LINE DRIVER WITH ADJUSTABLE SLEW RATE

SLLS110B – OCTOBER 1980 – REVISED MAY 1995

electrical characteristics over recommended ranges of free-air temperature, supply voltage, and wave-shaping resistance (unless otherwise noted)

PARAMETER		TEST CONDITIONS		MIN	TYP [†]	MAX	UNIT
V _{IK}	Input clamp voltage	I _I = -15 mA		-1.1	-1.5		V
V _{OH}	High-level output voltage	V _I = 0.8 V	R _L = ∞	5	5.6	6	V
			R _L = 3 kΩ to GND	5	5.6	6	
			R _L = 450 Ω to GND	4	5.4	6	
V _{OL}	Low-level output voltage	V _I = 2 V	R _L = ∞	-6 [‡]	-5.7	-5	V
			R _L = 3 kΩ to GND	-6 [‡]	-5.6	-5	
			R _L = 450 Ω to GND	-6 [‡]	-5.4	-4	
I _{IH}	High-level input current	V _I = 2.4 V				10	μA
		V _I = 5.5 V				100	
I _{IL}	Low-level input current	V _I = 0.4 V			-20	-80	μA
I _O	Output current (power off)	V _{CC±} = 0, V _O = ±6 V				±100	μA
I _{OS}	Short-circuit output current [§]	V _I = 2 V		15	25	150	mA
		V _I = 0		-15	-40	-150	
r _O	Output resistance	R _L = 450 Ω			25	50	Ω
I _{CC+}	Positive supply current	V _{CC} = ±12 V, R _(WS) = 100 kΩ,	V _I = 0, Output open		13	18	mA
I _{CC-}	Negative supply current	V _{CC} = ±12 V, R _(WS) = 100 kΩ,	V _I = 0, Output open		-13	-18	mA

[†] All typical values are at V_{CC} = ±12 V, T_A = 25°C.

[‡] The algebraic convention, in which the less-positive (more-negative) limit is designated as minimum, is used in this data sheet for logic voltage levels, e.g., when -5 V is the maximum, the minimum is a more-negative voltage.

[§] Not more than one output should be shorted to ground at a time.

switching characteristics, V_{CC±} = ±12 V, T_A = 25°C (see Figure 1)

PARAMETER		TEST CONDITIONS		MIN	TYP	MAX	UNIT
t _{TLH}	Transition time, low- to high-level output	R _L = 450 kΩ, C _L = 30 pF	R _(WS) = 10 kΩ	0.8	1.1	1.4	μs
			R _(WS) = 100 kΩ	8	11	14	
			R _(WS) = 500 kΩ	40	55	70	
			R _(WS) = 1 MΩ	80	110	140	
t _{THL}	Transition time, high- to low-level output	R _L = 450 kΩ, C _L = 30 pF	R _(WS) = 10 kΩ	0.8	1.1	1.4	μs
			R _(WS) = 100 kΩ	8	11	14	
			R _(WS) = 500 kΩ	40	55	70	
			R _(WS) = 1 MΩ	80	110	140	



uA9636AC DUAL LINE DRIVER WITH ADJUSTABLE SLEW RATE

SLLS110B – OCTOBER 1980 – REVISED MAY 1995

PARAMETER MEASUREMENT INFORMATION

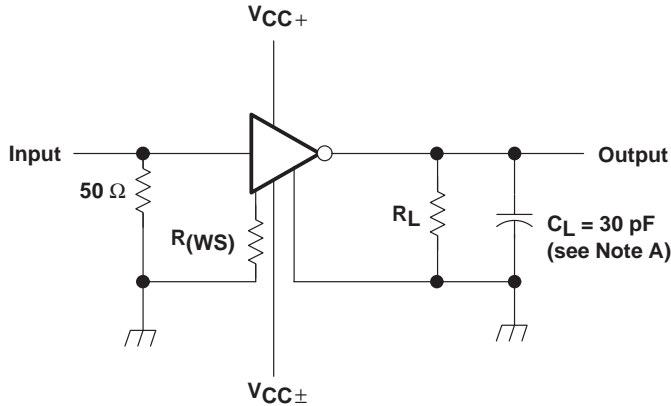

TEST CIRCUIT

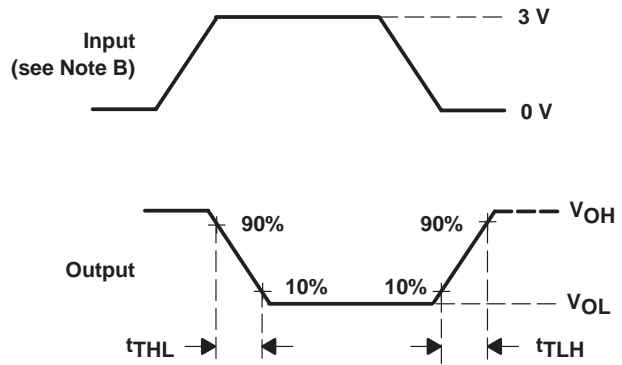

VOLTAGE WAVEFORMS

- NOTES: A. C_L includes probe and jig capacitance.
 B. The input pulse is supplied by a generator having the following characteristics: $t_r \leq 10$ ns, $t_f \leq 10$ ns, $Z_0 = 50 \Omega$, $PRR \leq 1$ kHz, duty cycle = 50%.

Figure 1. Test Circuit and Voltage Waveforms

TYPICAL CHARACTERISTICS

OUTPUT VOLTAGE
vs
INPUT VOLTAGE

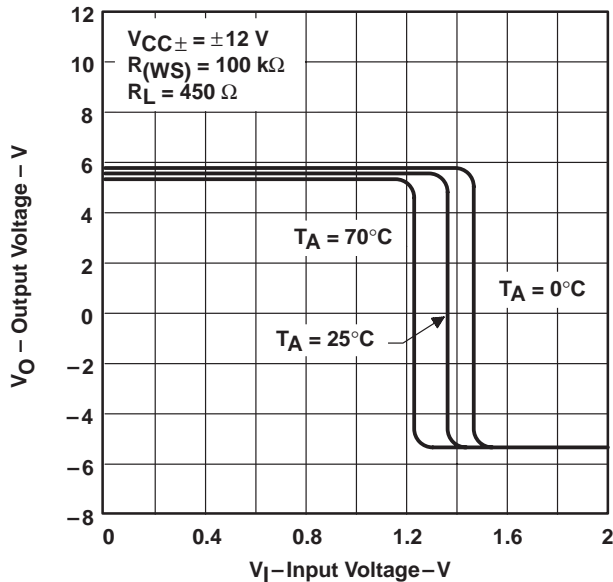

Figure 2

INPUT CURRENT
vs
INPUT VOLTAGE

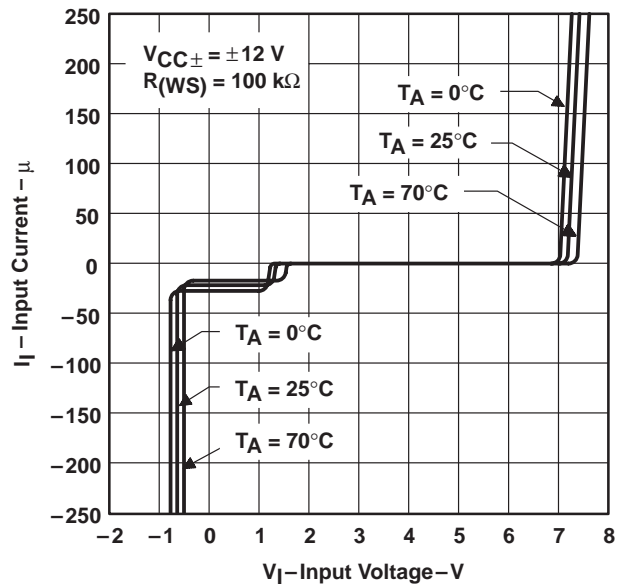
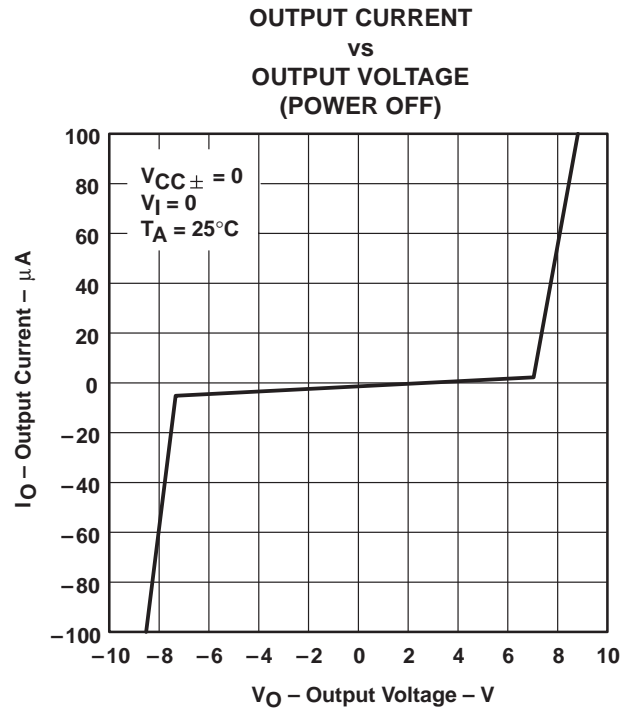
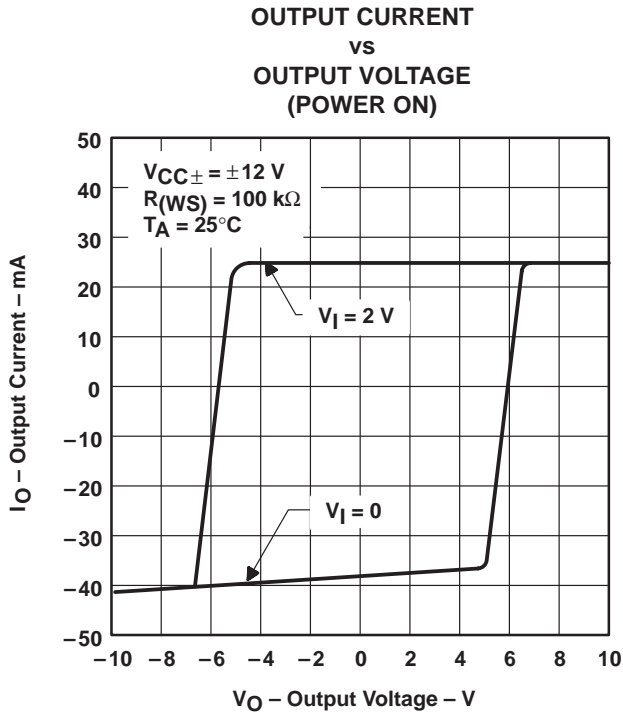
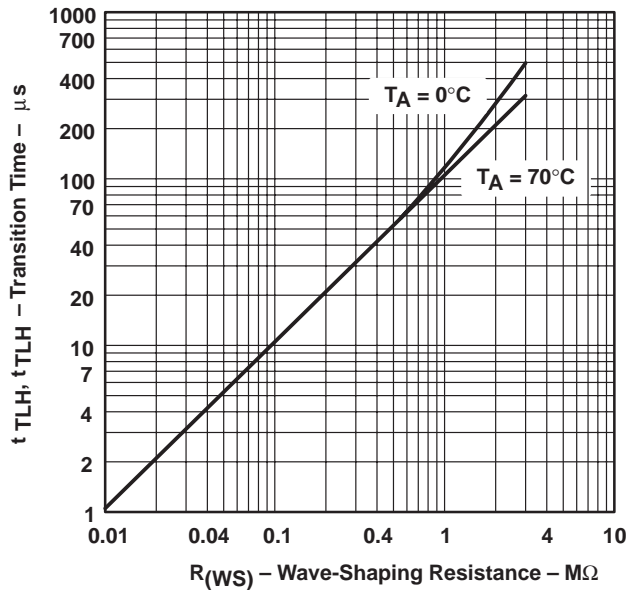

Figure 3

TYPICAL CHARACTERISTICS



**TRANSITION TIME
vs
WAVE-SHAPING RESISTANCE**



uA9636AC DUAL LINE DRIVER WITH ADJUSTABLE SLEW RATE

SLLS110B – OCTOBER 1980 – REVISED MAY 1995

APPLICATION INFORMATION

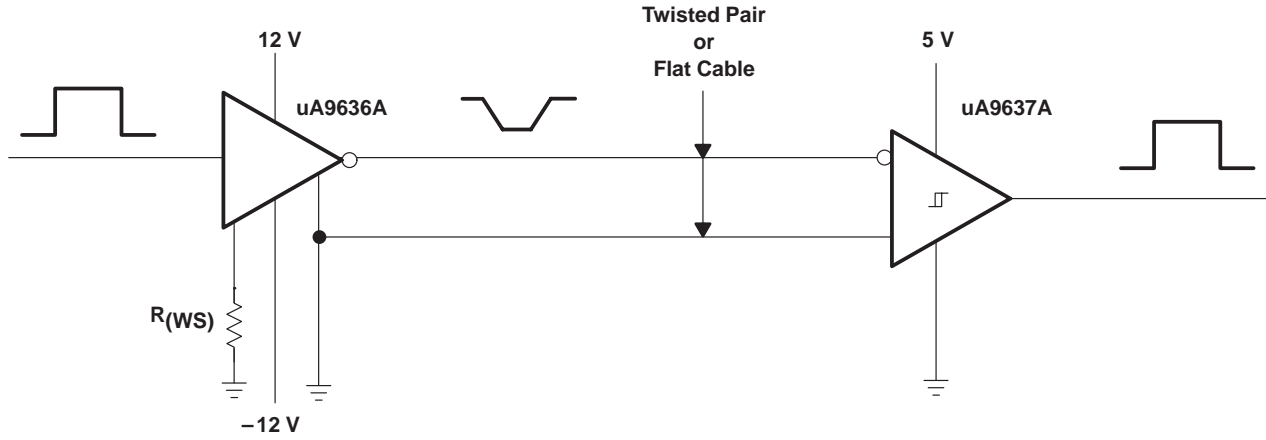

Figure 7. EIA/TIA-423-B System Application

PACKAGING INFORMATION

Orderable Device	Status ⁽¹⁾	Package Type	Package Drawing	Pins	Package Qty	Eco Plan ⁽²⁾	Lead/Ball Finish	MSL Peak Temp ⁽³⁾
UA9636ACD	ACTIVE	SOIC	D	8	75	Green (RoHS & no Sb/Br)	CU NIPDAU	Level-1-260C-UNLIM
UA9636ACDE4	ACTIVE	SOIC	D	8	75	Green (RoHS & no Sb/Br)	CU NIPDAU	Level-1-260C-UNLIM
UA9636ACDG4	ACTIVE	SOIC	D	8	75	Green (RoHS & no Sb/Br)	CU NIPDAU	Level-1-260C-UNLIM
UA9636ACDR	ACTIVE	SOIC	D	8	2500	Green (RoHS & no Sb/Br)	CU NIPDAU	Level-1-260C-UNLIM
UA9636ACDRE4	ACTIVE	SOIC	D	8	2500	Green (RoHS & no Sb/Br)	CU NIPDAU	Level-1-260C-UNLIM
UA9636ACDRG4	ACTIVE	SOIC	D	8	2500	Green (RoHS & no Sb/Br)	CU NIPDAU	Level-1-260C-UNLIM
UA9636ACJG	OBSOLETE	CDIP	JG	8		TBD	Call TI	Call TI
UA9636ACP	ACTIVE	PDIP	P	8	50	Pb-Free (RoHS)	CU NIPDAU	N / A for Pkg Type
UA9636ACPE4	ACTIVE	PDIP	P	8	50	Pb-Free (RoHS)	CU NIPDAU	N / A for Pkg Type

⁽¹⁾ The marketing status values are defined as follows:

ACTIVE: Product device recommended for new designs.

LIFEBUY: TI has announced that the device will be discontinued, and a lifetime-buy period is in effect.

NRND: Not recommended for new designs. Device is in production to support existing customers, but TI does not recommend using this part in a new design.

PREVIEW: Device has been announced but is not in production. Samples may or may not be available.

OBSOLETE: TI has discontinued the production of the device.

⁽²⁾ Eco Plan - The planned eco-friendly classification: Pb-Free (RoHS), Pb-Free (RoHS Exempt), or Green (RoHS & no Sb/Br) - please check <http://www.ti.com/productcontent> for the latest availability information and additional product content details.

TBD: The Pb-Free/Green conversion plan has not been defined.

Pb-Free (RoHS): TI's terms "Lead-Free" or "Pb-Free" mean semiconductor products that are compatible with the current RoHS requirements for all 6 substances, including the requirement that lead not exceed 0.1% by weight in homogeneous materials. Where designed to be soldered at high temperatures, TI Pb-Free products are suitable for use in specified lead-free processes.

Pb-Free (RoHS Exempt): This component has a RoHS exemption for either 1) lead-based flip-chip solder bumps used between the die and package, or 2) lead-based die adhesive used between the die and leadframe. The component is otherwise considered Pb-Free (RoHS compatible) as defined above.

Green (RoHS & no Sb/Br): TI defines "Green" to mean Pb-Free (RoHS compatible), and free of Bromine (Br) and Antimony (Sb) based flame retardants (Br or Sb do not exceed 0.1% by weight in homogeneous material)

⁽³⁾ MSL, Peak Temp. -- The Moisture Sensitivity Level rating according to the JEDEC industry standard classifications, and peak solder temperature.

Important Information and Disclaimer:The information provided on this page represents TI's knowledge and belief as of the date that it is provided. TI bases its knowledge and belief on information provided by third parties, and makes no representation or warranty as to the accuracy of such information. Efforts are underway to better integrate information from third parties. TI has taken and continues to take reasonable steps to provide representative and accurate information but may not have conducted destructive testing or chemical analysis on incoming materials and chemicals. TI and TI suppliers consider certain information to be proprietary, and thus CAS numbers and other limited information may not be available for release.

In no event shall TI's liability arising out of such information exceed the total purchase price of the TI part(s) at issue in this document sold by TI to Customer on an annual basis.

TAPE AND REEL INFORMATION

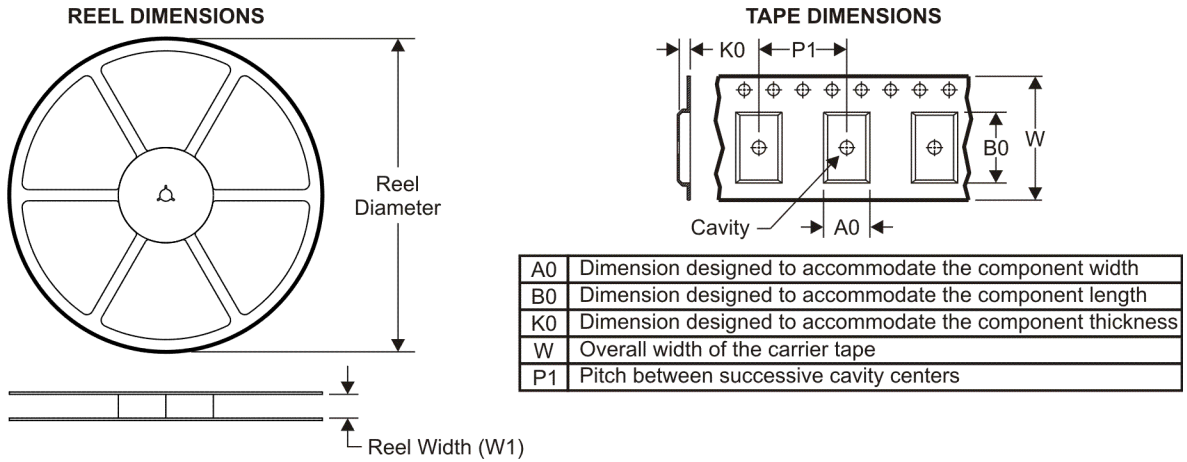

QUADRANT ASSIGNMENTS FOR PIN 1 ORIENTATION IN TAPE



*All dimensions are nominal

Device	Package Type	Package Drawing	Pins	SPQ	Reel Diameter (mm)	Reel Width W1 (mm)	A0 (mm)	B0 (mm)	K0 (mm)	P1 (mm)	W (mm)	Pin1 Quadrant
UA9636ACDR	SOIC	D	8	2500	330.0	12.4	6.4	5.2	2.1	8.0	12.0	Q1

TAPE AND REEL BOX DIMENSIONS



*All dimensions are nominal

Device	Package Type	Package Drawing	Pins	SPQ	Length (mm)	Width (mm)	Height (mm)
UA9636ACDR	SOIC	D	8	2500	340.5	338.1	20.6

JG (R-GDIP-T8)

CERAMIC DUAL-IN-LINE



- NOTES: A. All linear dimensions are in inches (millimeters).
 B. This drawing is subject to change without notice.
 C. This package can be hermetically sealed with a ceramic lid using glass frit.
 D. Index point is provided on cap for terminal identification.
 E. Falls within MIL STD 1835 GDIP1-T8

P (R-PDIP-T8)

PLASTIC DUAL-IN-LINE PACKAGE



- NOTES:
- A. All linear dimensions are in inches (millimeters).
 - B. This drawing is subject to change without notice.
 - C. Falls within JEDEC MS-001 variation BA.

D (R-PDSO-G8)

PLASTIC SMALL OUTLINE



4040047-3/M 06/11

D (R-PDSO-G8)

PLASTIC SMALL OUTLINE



4211283-2/E 08/12

- NOTES:
- A. All linear dimensions are in millimeters.
 - B. This drawing is subject to change without notice.
 - C. Publication IPC-7351 is recommended for alternate designs.
 - D. Laser cutting apertures with trapezoidal walls and also rounding corners will offer better paste release. Customers should contact their board assembly site for stencil design recommendations. Refer to IPC-7525 for other stencil recommendations.
 - E. Customers should contact their board fabrication site for solder mask tolerances between and around signal pads.

IMPORTANT NOTICE

Texas Instruments Incorporated and its subsidiaries (TI) reserve the right to make corrections, enhancements, improvements and other changes to its semiconductor products and services per JESD46C and to discontinue any product or service per JESD48B. Buyers should obtain the latest relevant information before placing orders and should verify that such information is current and complete. All semiconductor products (also referred to herein as "components") are sold subject to TI's terms and conditions of sale supplied at the time of order acknowledgment.

TI warrants performance of its components to the specifications applicable at the time of sale, in accordance with the warranty in TI's terms and conditions of sale of semiconductor products. Testing and other quality control techniques are used to the extent TI deems necessary to support this warranty. Except where mandated by applicable law, testing of all parameters of each component is not necessarily performed.

TI assumes no liability for applications assistance or the design of Buyers' products. Buyers are responsible for their products and applications using TI components. To minimize the risks associated with Buyers' products and applications, Buyers should provide adequate design and operating safeguards.

TI does not warrant or represent that any license, either express or implied, is granted under any patent right, copyright, mask work right, or other intellectual property right relating to any combination, machine, or process in which TI components or services are used. Information published by TI regarding third-party products or services does not constitute a license to use such products or services or a warranty or endorsement thereof. Use of such information may require a license from a third party under the patents or other intellectual property of the third party, or a license from TI under the patents or other intellectual property of TI.

Reproduction of significant portions of TI information in TI data books or data sheets is permissible only if reproduction is without alteration and is accompanied by all associated warranties, conditions, limitations, and notices. TI is not responsible or liable for such altered documentation. Information of third parties may be subject to additional restrictions.

Resale of TI components or services with statements different from or beyond the parameters stated by TI for that component or service voids all express and any implied warranties for the associated TI component or service and is an unfair and deceptive business practice. TI is not responsible or liable for any such statements.

Buyer acknowledges and agrees that it is solely responsible for compliance with all legal, regulatory and safety-related requirements concerning its products, and any use of TI components in its applications, notwithstanding any applications-related information or support that may be provided by TI. Buyer represents and agrees that it has all the necessary expertise to create and implement safeguards which anticipate dangerous consequences of failures, monitor failures and their consequences, lessen the likelihood of failures that might cause harm and take appropriate remedial actions. Buyer will fully indemnify TI and its representatives against any damages arising out of the use of any TI components in safety-critical applications.

In some cases, TI components may be promoted specifically to facilitate safety-related applications. With such components, TI's goal is to help enable customers to design and create their own end-product solutions that meet applicable functional safety standards and requirements. Nonetheless, such components are subject to these terms.

No TI components are authorized for use in FDA Class III (or similar life-critical medical equipment) unless authorized officers of the parties have executed a special agreement specifically governing such use.

Only those TI components which TI has specifically designated as military grade or "enhanced plastic" are designed and intended for use in military/aerospace applications or environments. Buyer acknowledges and agrees that any military or aerospace use of TI components which have **not** been so designated is solely at the Buyer's risk, and that Buyer is solely responsible for compliance with all legal and regulatory requirements in connection with such use.

TI has specifically designated certain components which meet ISO/TS16949 requirements, mainly for automotive use. Components which have not been so designated are neither designed nor intended for automotive use; and TI will not be responsible for any failure of such components to meet such requirements.

Products

Audio	www.ti.com/audio
Amplifiers	amplifier.ti.com
Data Converters	dataconverter.ti.com
DLP® Products	www.dlp.com
DSP	dsp.ti.com
Clocks and Timers	www.ti.com/clocks
Interface	interface.ti.com
Logic	logic.ti.com
Power Mgmt	power.ti.com
Microcontrollers	microcontroller.ti.com
RFID	www.ti-rfid.com
OMAP Mobile Processors	www.ti.com/omap
Wireless Connectivity	www.ti.com/wirelessconnectivity

Applications

Automotive and Transportation	www.ti.com/automotive
Communications and Telecom	www.ti.com/communications
Computers and Peripherals	www.ti.com/computers
Consumer Electronics	www.ti.com/consumer-apps
Energy and Lighting	www.ti.com/energy
Industrial	www.ti.com/industrial
Medical	www.ti.com/medical
Security	www.ti.com/security
Space, Avionics and Defense	www.ti.com/space-avionics-defense
Video and Imaging	www.ti.com/video

TI E2E Community e2e.ti.com