

# STA341M

Silicon NPN, PNP Triple Diffused Planar

## Maximum Ratings

(Ta = 25°C)

Item	Symbol	Ratings		Unit
		NPN	PNP	
Collector-to-Base Voltage	V <sub>CB0</sub>	30	-30	V
Collector-to-Emitter Voltage	V <sub>CE0</sub>	30	-30	V
Emitter-to-Base Voltage	V <sub>EB0</sub>	6	-6	V
Collector Current	I <sub>c</sub>	1	-1	A
Base Current	I <sub>B</sub>	0.1	-0.1	A
Total Power Dissipation	P <sub>T</sub>	2.2 (Ta = 25°C)		W
Operating Junction Temperature	T <sub>J</sub>	150		°C
Storage Temperature	T <sub>stg</sub>	-40 ~ +150		°C

## Electrical Characteristics

(Ta = 25°C)

Item	Symbol	Conditions	NPN			PNP			Unit
			Specification			Specification			
			min	typ	max	min	typ	max	
Collector Cut-off Current	I <sub>cBO</sub>	V <sub>CB</sub> = -30V			10	V <sub>CB</sub> = -30V			μA
Emitter Cut-off Current	I <sub>eBO</sub>	V <sub>EB</sub> = 6V			10	V <sub>EB</sub> = -6V			mA
Collector-to-Emitter Voltage	V <sub>CE0</sub>	I <sub>c</sub> = 10mA	30			I <sub>c</sub> = -10mA	-30		V
DC Forward Current Transfer Ratio	h <sub>FE</sub>	V <sub>CE</sub> = 4V, I <sub>c</sub> = 0.3A	100			V <sub>CE</sub> = -4V, I <sub>c</sub> = -0.3A	100		
Collector-to-Emitter Saturation Voltage	V <sub>CE(sat)</sub>	I <sub>c</sub> = 300mA, I <sub>B</sub> = 10mA			0.5	I <sub>c</sub> = -300mA, I <sub>B</sub> = -10mA			-0.5 V
Turn on Time	t <sub>on</sub>	I <sub>c</sub> = 0.3A I <sub>B1</sub> = -I <sub>B2</sub> = 10mA		0.22		I <sub>c</sub> = -0.3A I <sub>B1</sub> = -I <sub>B2</sub> = -10mA		0.25	μs
Storage Time	t <sub>stg</sub>			1.4				0.54	μs
Fall Time	t <sub>f</sub>			0.28				0.3	μs

## Equivalent Circuit Diagram

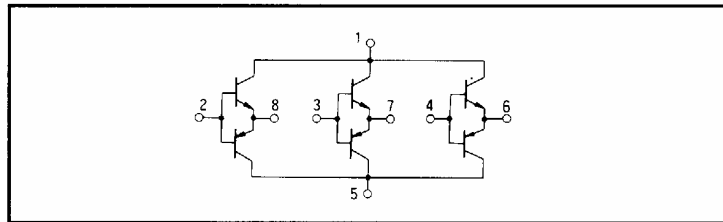

## Characteristic Curves

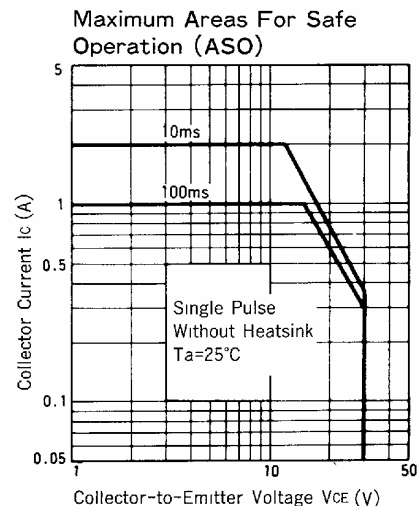
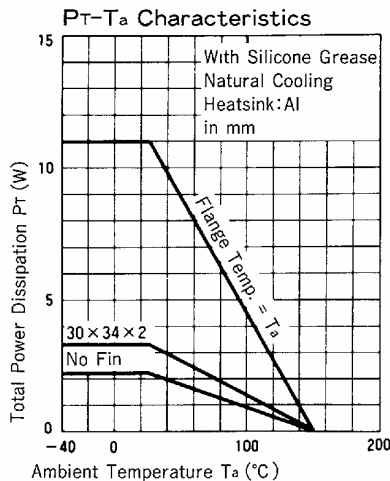

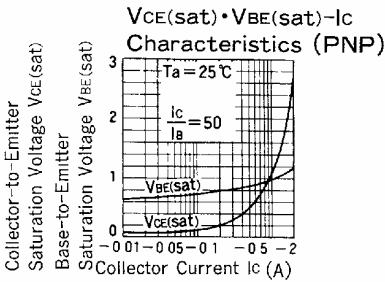
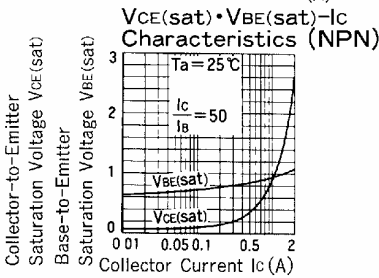
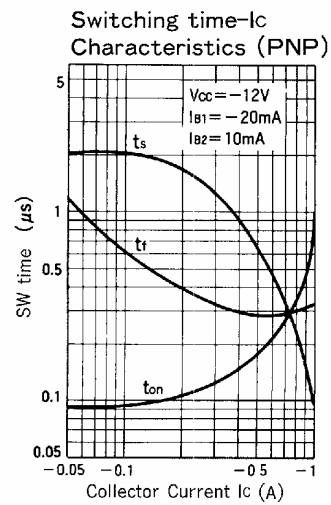
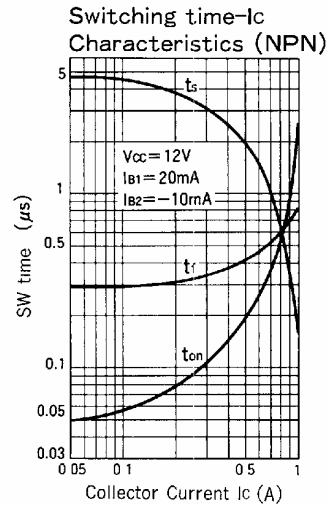
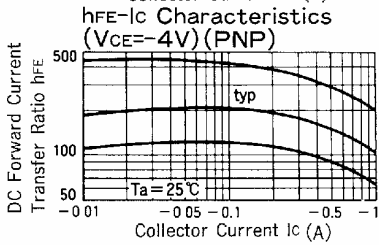
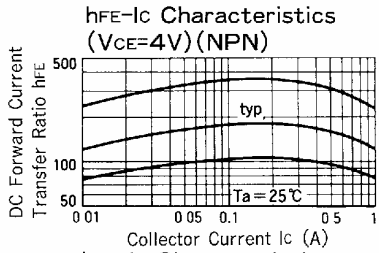
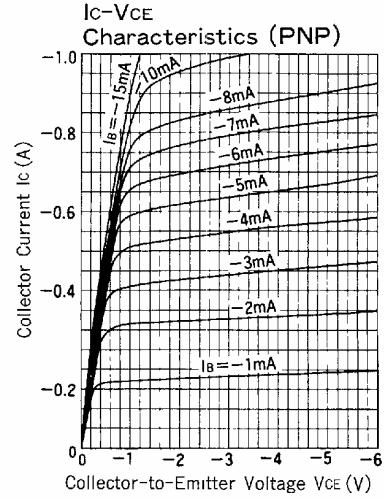
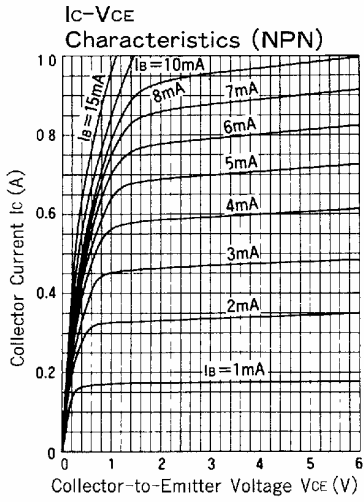

# Notes on using products

## Outline Drawings (Unit:in mm)

### STA Family

#### STA300 Series

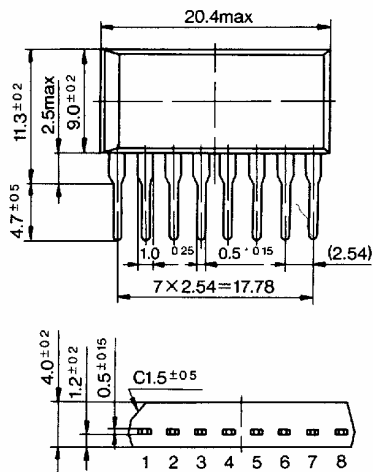

Weight Approx. 2.0g

#### STA400 Series

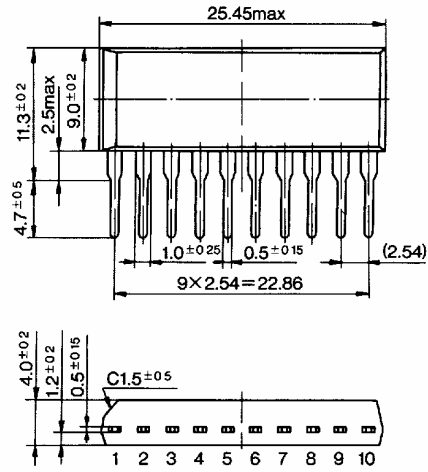

Weight Approx. 2.6g

### SMA Family

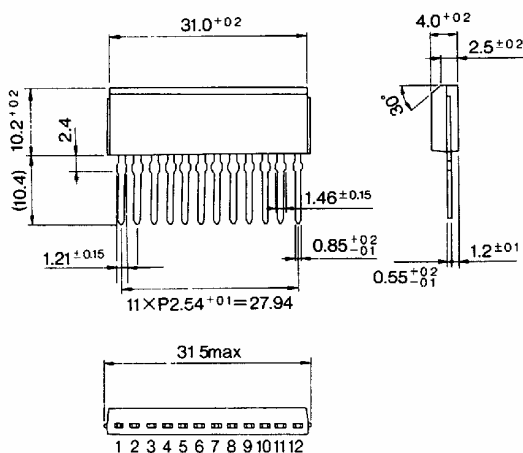

Weight Approx. 4.0g

### SLA Family

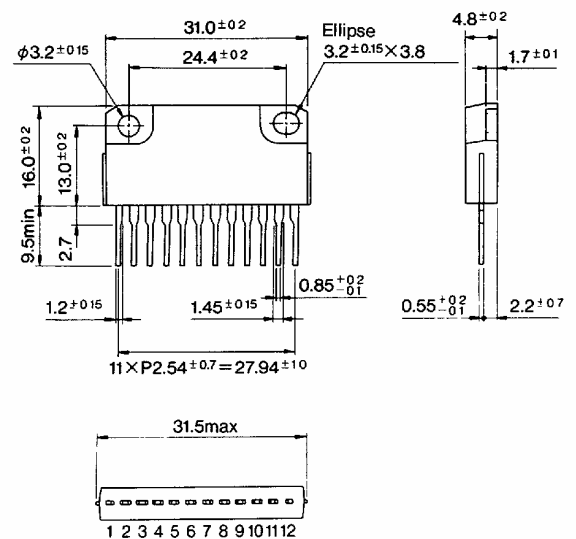

Weight Approx. 6.0g