

GaAIAs-IR-Lumineszenzdiode (880 nm) GaAIAs Infrared Emitter (880 nm)

SFH 485 P

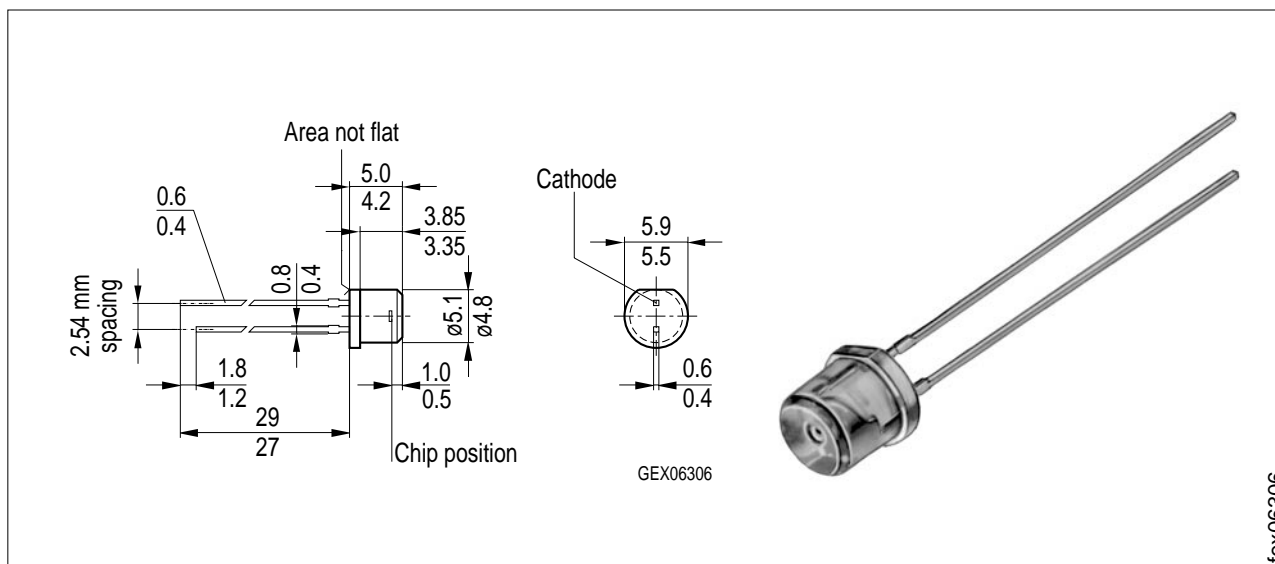

Maße in mm, wenn nicht anders angegeben/Dimensions in mm, unless otherwise specified.

Wesentliche Merkmale

- GaAIAs-IR-Lumineszenzdiode, hergestellt im Schmelzepitaxieverfahren
- Enge Toleranz: Chipoberfläche/Bauteiloberkante
- Gute spektrale Anpassung an Si-Fotoempfänger
- Sehr plane Oberfläche
- Gehäusegleich mit SFH 217

Anwendungen

- Lichtschranken für Gleich- und Wechsellichtbetrieb bis 500 kHz
- LWL

Features

- GaAIAs infrared emitting diode, fabricated in a liquid phase epitaxy process
- Small tolerance: Chip surface to case surface
- Good spectral match to silicon photodetectors
- Plane surface
- Same package as SFH 217

Applications

- Light-reflection switches for steady and varying intensity (max. 500 kHz)
- Fibre optic transmission

Typ Type	Bestellnummer Ordering Code	Gehäuse Package
SFH 485 P	Q62703-Q516	5-mm-LED-Gehäuse, plan, klares violettes Epoxy-Gießharz, Lötspieße im 2.54-mm-Raster ($1/10''$), Anodenkennzeichnung: kürzerer Anschluß 5 mm LED package (T $1\frac{3}{4}$), plane violet-colored transparent epoxy resin, solder tabs lead spacing 2.54 mm ($1/10''$), anode marking: short lead.

Grenzwerte ($T_A = 25\text{ °C}$)

Maximum Ratings

Bezeichnung Description	Symbol Symbol	Wert Value	Einheit Unit
Betriebs- und Lagertemperatur Operating and storage temperature range	$T_{op}; T_{stg}$	- 55 ... + 100	°C
Sperrschichttemperatur Junction temperature	T_j	100	°C
Sperrspannung Reverse voltage	V_R	5	V
Durchlaßstrom Forward current	I_F	100	mA
Stoßstrom, $\tau \leq 10\ \mu\text{s}$ Surge current	I_{FSM}	2.5	A
Verlustleistung Power dissipation	P_{tot}	200	mW
Wärmewiderstand, freie Beinchenlänge max. 10 mm Thermal resistance, lead length between package bottom and PC-board max. 10 mm	R_{thJA}	375	K/W

Kennwerte ($T_A = 25\text{ °C}$)

Characteristics

Bezeichnung Description	Symbol Symbol	Wert Value	Einheit Unit
Wellenlänge der Strahlung Wavelength at peak emission $I_F = 100\text{ mA}$	λ_{peak}	880	nm
Spektrale Bandbreite bei 50 % von I_{max} , $I_F = 100\text{ mA}$ Spectral bandwidth at 50 % of I_{max}	$\Delta\lambda$	80	nm
Abstrahlwinkel Half angle	φ	± 40	Grad deg.
Aktive Chipfläche Active chip area	A	0.16	mm ²
Abmessungen der aktiven Chipfläche Dimension of the active chip area	$L \times B$ $L \times W$	0.4×0.4	mm
Abstand Chipoberfläche bis Gehäusevorderseite Distance chip front to case surface	H	0.5 ... 1	mm

Kennwerte ($T_A = 25\text{ °C}$)
Characteristics (cont'd)

Bezeichnung Description	Symbol Symbol	Wert Value	Einheit Unit
Schaltzeiten, I_e von 10 % auf 90 % und von 90 % auf 10 %, bei $I_F = 100\text{ mA}$, $R_L = 50\ \Omega$ Switching times, I_e from 10 % to 90 % and from 90 % to 10 %, $I_F = 100\text{ mA}$, $R_L = 50\ \Omega$	t_r, t_f	0.6/0.5	μs
Kapazität Capacitance $V_R = 0\text{ V}$, $f = 1\text{ MHz}$	C_o	25	pF
Durchlaßspannung Forward voltage $I_F = 100\text{ mA}$, $t_p = 20\text{ ms}$ $I_F = 1\text{ A}$, $t_p = 100\ \mu\text{s}$	V_F	1.5 (< 1.8) 3.0 (< 3.8)	V
Sperrstrom Reverse current $V_R = 5\text{ V}$	I_R	0.01 (≤ 1)	μA
Gesamtstrahlungsfluß Total radiant flux $I_F = 100\text{ mA}$, $t_p = 20\text{ ms}$	Φ_e	25	mW
Temperaturkoeffizient von I_e bzw. Φ_e , $I_F = 100\text{ mA}$ Temperature coefficient of I_e or Φ_e , $I_F = 100\text{ mA}$	TC_I	- 0.5	%/K
Temperaturkoeffizient von V_F , $I_F = 100\text{ mA}$ Temperature coefficient of V_F , $I_F = 100\text{ mA}$	TC_V	- 2	mV/K
Temperaturkoeffizient von λ_{peak} , $I_F = 100\text{ mA}$ Temperature coefficient of λ_{peak} , $I_F = 100\text{ mA}$	TC_λ	0.25	nm/K

Strahlstärke I_e in Achsrichtung

gemessen bei einem Raumwinkel $\Omega = 0.01\text{ sr}$

Grouping at radiant intensity I_e in axial direction

at a solid angle of $\Omega = 0.01\text{ sr}$

Bezeichnung Description	Symbol	Werte Values	Einheit Unit
Strahlstärke Radiant intensity $I_F = 100\text{ mA}$, $t_p = 20\text{ ms}$	I_e	> 3.15	mW/sr
Strahlstärke Radiant intensity $I_F = 1\text{ A}$, $t_p = 100\ \mu\text{s}$	$I_{e\text{ typ.}}$	48	mW/sr

Relative spectral emission

$$I_{rel} = f(\lambda)$$

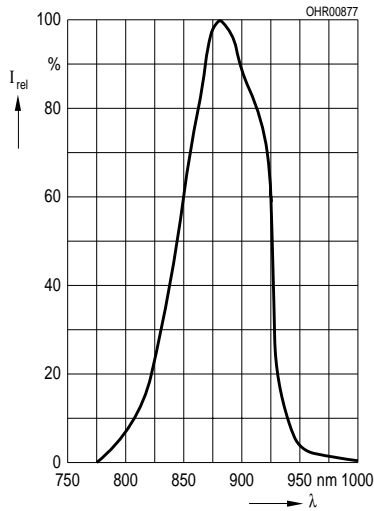

Radiant intensity $\frac{I_e}{I_e(100\text{ mA})} = f(I_F)$

Single pulse, $t_p = 20 \mu\text{s}$

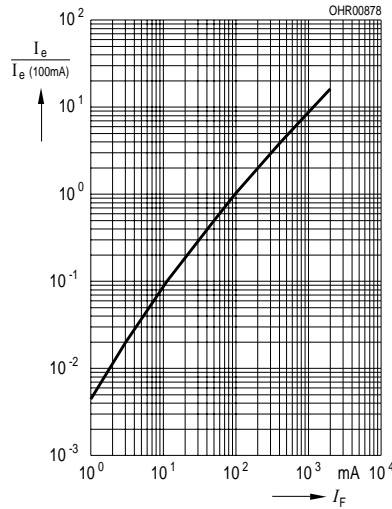

Max. permissible forward current

$$I_F = f(T_A)$$

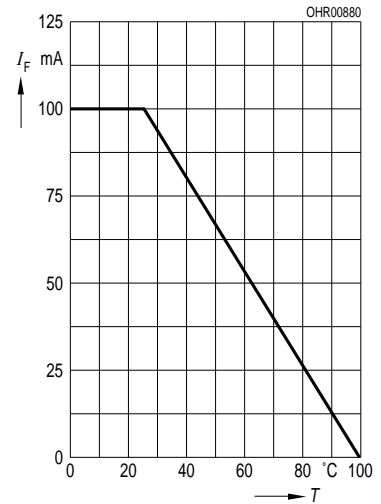

Forward current, $I_F = f(V_F)$

Single pulse, $t_p = 20 \mu\text{s}$

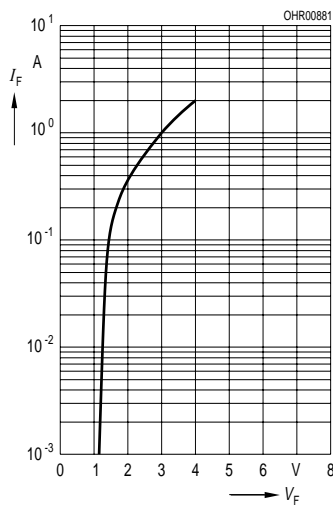

Permissible pulse handling capability

$I_F = f(\tau)$, $T_A = 25 \text{ }^\circ\text{C}$,
duty cycle $D =$ parameter

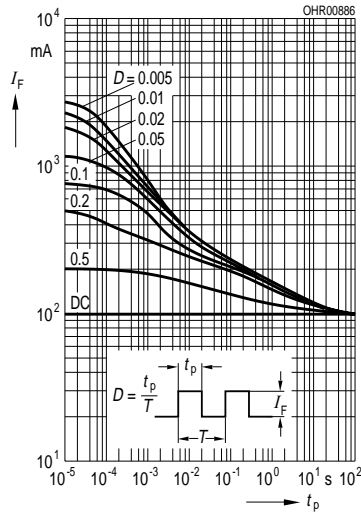

Forward current versus lead length between the package bottom and the PC-board $I_F = f(l)$, $T_A = 25 \text{ }^\circ\text{C}$

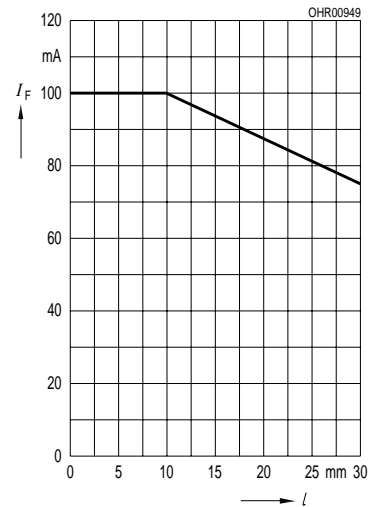

Radiation characteristics $I_{rel} = f(\varphi)$

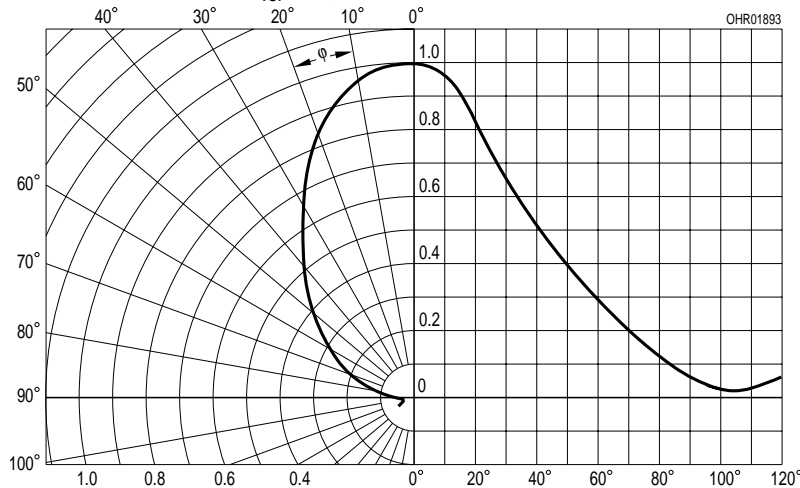

This datasheet has been downloaded from:

www.DatasheetCatalog.com

Datasheets for electronic components.