

PV Charge Controller

SBC-6108 / 6112 / 6120 / 6130

User's Manual

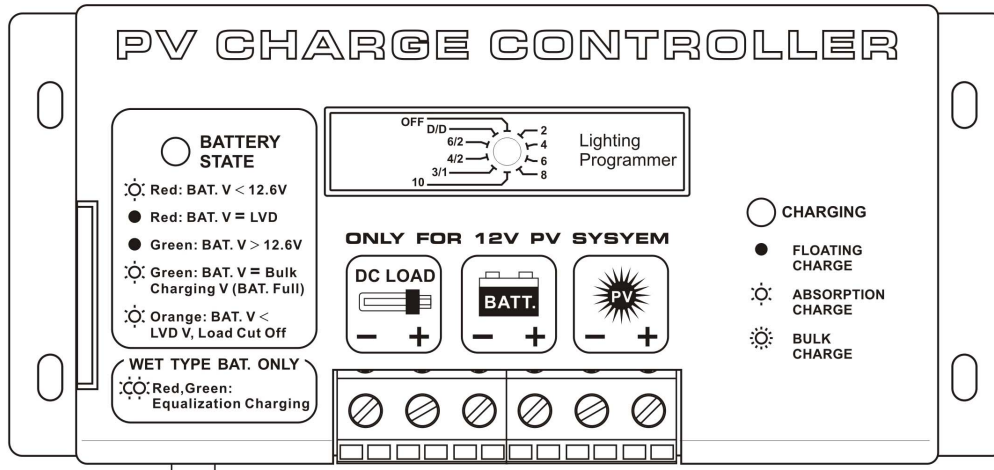

Table of Contents

Precautions and Specifications	1
1. Introduction	2
2. Control and Indicator	2
3. Installation and Indication	3
3.1 Connection.....	3
3.2 LED Indicator.....	3
3.3 Charging LED Indicator.....	4
3.4 The Dip Switch.....	4
3.4.1 Bulk Charge Voltage Setting for Sealed and Wet-type Lead Acid Battery.....	4
3.4.2 Select the Auto-Equalization charging and Night-Light Mode.....	4
4. PV Charge Control Mode	5
4.1 3-Stage Charge Control.....	5
4.2 Equalization Charging Mode (Automatic or Manual).....	6
4.2.1 Automatic Equalization Charging.....	6
4.2.2 Manual Equalization Charging.....	6
4.3 12V DC Load Terminal- Control Mode.....	6
4.3.1 Low Voltage Disconnect (LVD).....	6
4.3.2 Low Voltage Reconnect (LVR).....	6
4.3.3 Night-Light Mode Programs.....	6
4.4 Temperature Sensor (Optional).....	8
4.5 Over Temperature Protection.....	8
5. Remote Signal Terminal (Optional)	8

Precautions

1. Before using the charge/load controller, read all the instructions and cautionary markings on the charge/load controller, the batteries and the photovoltaic panels.
2. Do not attempt to repair the controller. Incorrect re-assembly may result in a risk of electric shock or fire.
3. To reduce risk of electric shock, disconnect all wiring before attempting any maintenance or cleaning. Turning off controls will not reduce this risk. PV panels produce power when exposed to light – cover them with opaque material before servicing.
4. Working in Vicinity of a Lead Acid Battery is dangerous. Batteries generate EXPLOSIVE gases during normal operation. Provide ventilation to outdoors from the highest point of the battery compartment.
5. This charge/load controller is intended to be used with a battery supply of 12VDC nominal voltage.
6. Be extra cautious to reduce the possibility of dropping a metal tool onto batteries. It might spark or short-circuit batteries or other electrical parts that may cause explosion. Cover wrench handles with plastic tape or vinyl dip coating material.

Specifications

Models

Battery voltage	12V
Maximum PV panel open circuit voltage	26V
Continuous load/charge current	8A 12A 20A 30A
Maximum charge current (5 mins)	10A 15A 25A 35A
Maximum load current (5 mins)	10A 20A 25A 35A
Operation current(no Load and no PV)	15mA
Voltage across terminals (PV to Battery)	0.6V 0.6V 0.8V 1.2V
Voltage across terminals (Battery to Load)	0.3V 0.3V 0.4V 0.6V
Electronic Blocking <i>(To protect against reverse polarity connection of PV panel and to block current from battery to PV panel when voltage of battery is higher than PV panel)</i>	Yes
Battery reverse polarity protection	Yes
Overcharge & Over-discharge protection	Yes
Battery status LED indication	5-State LED Indications
Charging status indication	3-State LED Indications
Recommended wire size	#12AWG #10AWG
Weight	0.44 kg
Dimension (WxDxH)	150 x 85 x 45 mm
Fuse	15A 20A 30A 40A
Operating ambient temperature	-10 to 50 °C
Over temperature protection	Yes
Battery charging float voltage setting	Factory Preset 13.4V
Battery charging bulk voltage setting	Factory Preset 14.3V
DC load control mode (For DC load terminal):	
Low Voltage Disconnect(LVD)	Factory Preset 11.5V
Low Voltage Reconnect(LVR)	Factory Preset 12.5V

SBC-6100 Series

6108	6112	6120	6130
12V			
26V			
8A	12A	20A	30A
10A	15A	25A	35A
10A	20A	25A	35A
15mA			
0.6V	0.6V	0.8V	1.2V
0.3V	0.3V	0.4V	0.6V
Yes			
Yes			
Yes			
5-State LED Indications			
3-State LED Indications			
#12AWG		#10AWG	
0.44 kg			
150 x 85 x 45 mm			
15A	20A	30A	40A
-10 to 50 °C			
Yes			
Factory Preset 13.4V			
Factory Preset 14.3V			
Factory Preset 11.5V			
Factory Preset 12.5V			

1. Introduction

The SBC-6108/6112/6120/6130 PV Charge Controller is designed for use with all types of 12V photovoltaic(PV) panels/systems and different types of 12V batteries, such as wet or sealed lead acid, lead calcium, lead antimony battery.

Numerous features are provided to maximize the performance of the system:

- Electronic Blocking (To protect against reverse polarity connection of PV panel and block current from battery to PV Panel when voltage of Battery is higher than PV panel),
- Suitable for PV panels with Open Circuit Voltage from 17 to 23V,
- Rated charging/load current 8A(SBC-6108) / 12A(SBC-6112) / 20A(SBC-6120) / 30A(SBC-6130),
- PWM Charging,
- Build-In Microprocessor for PV charge control to maximize the charging efficiency,
- Overcharge and Over-discharge Protection,
- 3-stage Charge Control(Bulk, Absorption & Float) to allow battery be left unattended for long period ,
- Over Temperature Protection,
- Night Light Mode 10 selections
- Short-Circuit Protection at load terminal & Battery Reverse Polarity Protection at Battery Connection Terminal,
- Tri-Color LED indication of system and battery conditions,
- **Optional** Temperature Sensor for compensated battery charging,
- **Optional** Remote Signal Terminal.

2. Control and Indicator

The following diagram shows the hardware interface of the PV Charge Controller.

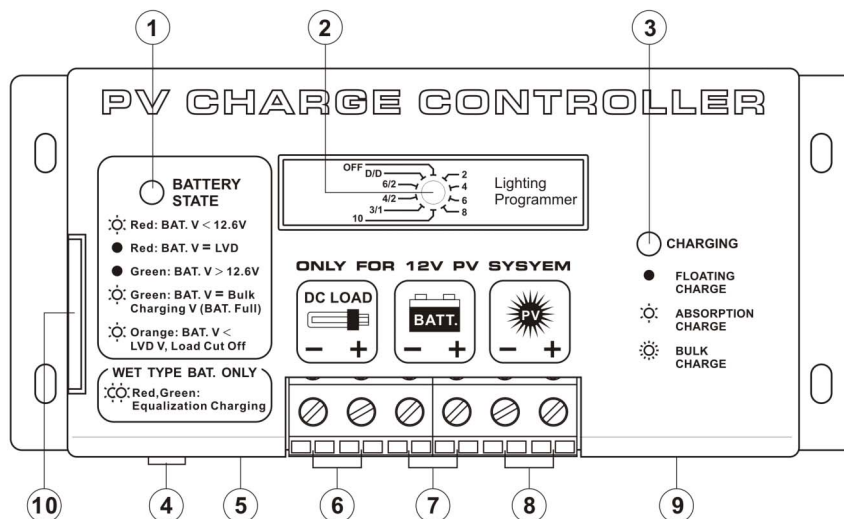

Figure. 1 Front view of PV Charge Controller

1. Battery LED Indicator
2. Lighting Programmer (Night-Light Mode Selections)
3. Charging LED Indicator
4. Reset button (see Section 3.4)
5. Temperature Sensor (Optional)
6. 12V DC Load terminal with Low Voltage Disconnect/NIGHT-LIGHT mode (Section 4.3)
7. 12V Battery connection terminal
8. PV Panel connection terminal
9. Remote Signal Terminal (Optional)
10. Side Door (open to access switches for setting)

3. Installation and Indication

3.1 Connection

The PV Charge Controller should be connected as follow:

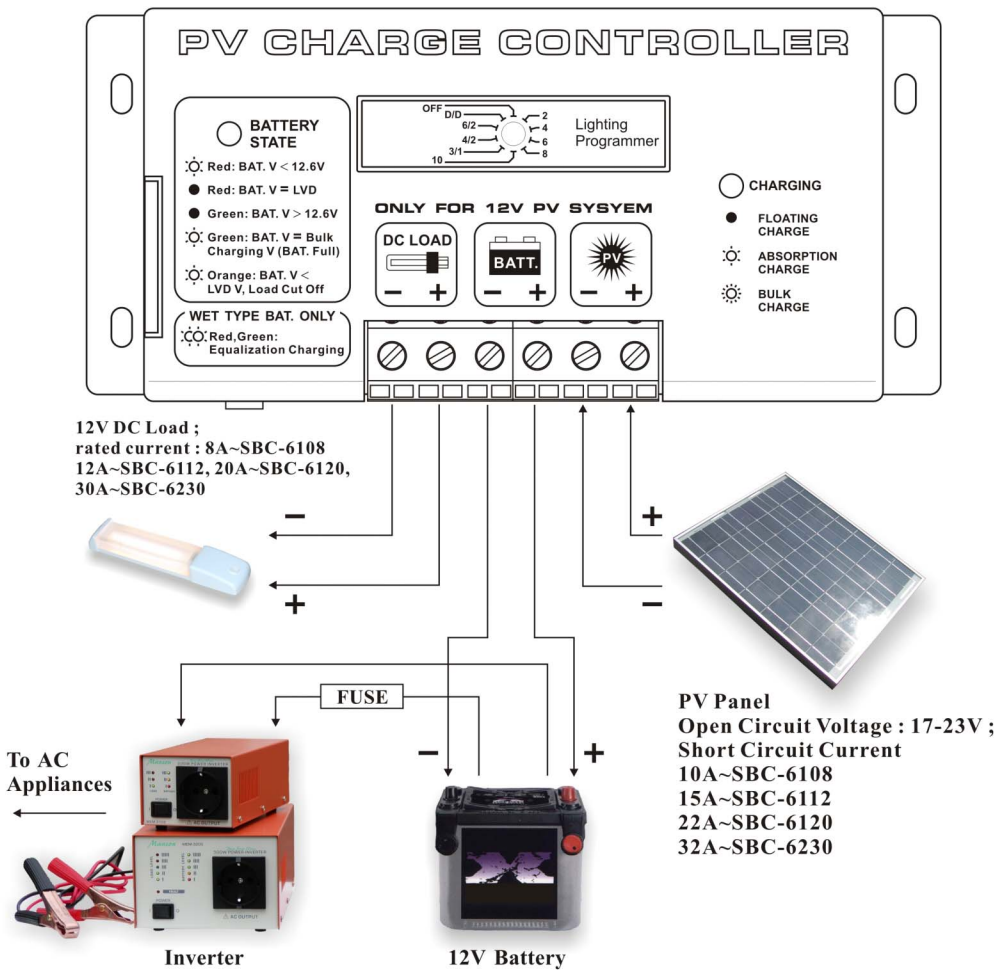

Figure. 2 Connection of PV Charge Controller

This controller has **Electronic Blocking** feature, therefore, it is not necessary to connect a diode between the PV module and the Controller.

The recommended wire size is #12AWG(SBC-6108/6112) / #10AWG(SBC-6120/6130).

It is recommended that the PV Charge Controller should be installed in a dry, sheltered location away from sources of high temperature and moisture.

3.2 LED Indicator

Red Flashing.....	Battery Voltage is lower than 12.6V
Constant Red.....	Battery Voltage has reached Low Voltage Disconnect(LVD)
Constant Green.....	Battery Voltage is higher than 12.6V
Green Flashing.....	Battery Voltage has reached Bulk Charging Setting. (Fully Charged)
Orange Flashing.....	Battery Voltage is lower than Low Voltage Disconnect (LVD) Voltage Setting and load has been disconnected.
Red-Green Flashing.....	Equalization Charging in process.

Table 1 LED Indications

3.3 Charging LED Indicator

It shows 3 charging modes – Bulk, Absorption and Float Charge.

<u>Charging LED Indicator</u>	<u>Charging Status</u>
Fast Flashing Green_____	Bulk Charge
Slow Flashing Green_____	Absorb Charge
Constant Green_____	Float Charge
LED off_____	No Charging

Table 2 Charging LED Indicator

3.4 The Dip Switch

Open the side door, you can see the dipswitch

The dip switch are used to select the **AUTO/MANUAL** equalization charging, **night-light mode ON/OFF selection** and **WET/SEALED** type Lead-Acid battery selection.

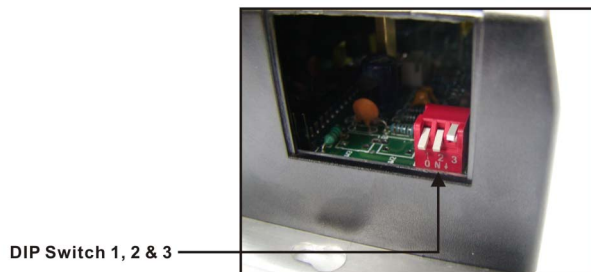

Figure. 3

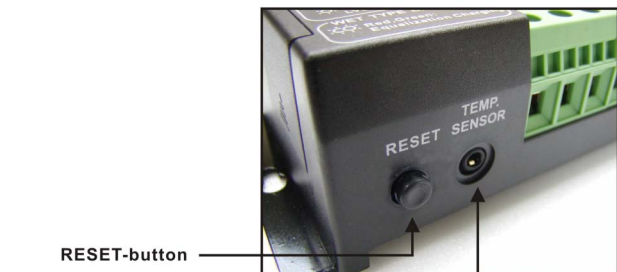

Figure. 4

Factory Preset

The following table shows the factory preset values of the PV Charge Controller :

Bulk Voltage	14.3V (Sealed-type lead acid battery)
Float Voltage	13.5V
Low Voltage Disconnect	11.5V
Low Voltage Reconnect	12.5V
Night Light Mode Option	Off (refer to section 4.3.3 table 5)

Table 3 Preset values of the adjustable parameters

3.4.1 Bulk Voltage Setting for Sealed and Wet-type Lead Acid Battery

The bulk voltage of sealed gel-type and wet-type lead acid battery are different.

The preset Bulk Setpoint (14.3V) is for typical Sealed Gel-type Lead Acid Battery.

The Dip switch 3 is set to **OFF position** .

For typical Wet-type Lead Acid Battery, set the Dip switch 3 to **ON position**.

The bulk voltage is 14.8V for Wet-type Lead Acid battery.

3.4.2 Select the Auto - Equalization Charging and Night-Light Mode

The dip switch 1 is for Night-Light Mode , switch 2 for Equalization Charging mode.

THE PV CHARGE CONTROLLER IS FACTORY PRESET FOR USE WITH SEAL TYPE BATTERY THAT IS : NO AUTO EQUILIZATION CHARGING BECAUSE DIP SWITCH 2 IS AT ON POSITION.

* Equalization(Eq.) charging is only for wet-type Lead Acid Battery

When Auto-Equalization Charging is set at ON mode, Equalization charge will occur for 2 hours once every thirty days.

Use the dip switch to select equalization charging and night-light mode as below:



AUTO Equalization Charging*	Night-Light Mode	Dip Switch Settings
OFF	<i>OFF</i>	 Dip switch 1 – <i>OFF</i> Dip switch 2 – ON Dip switch 3 - <i>OFF</i> <div style="border: 1px solid black; padding: 2px; display: inline-block; margin-left: 10px;">Factory Preset</div>
OFF	<i>ON</i>	 Dip switch 1 – <i>ON</i> Dip switch 2 – ON Dip switch 3 - <i>OFF</i>
ON	<i>OFF</i>	 Dip switch 1 – <i>OFF</i> Dip switch 2 – OFF Dip switch 3 - ON
ON	<i>ON</i>	 Dip switch 1 – <i>ON</i> Dip switch 2 – OFF Dip switch 3 - ON

Table 4 Dip Switch Functions

4. PV Charge Control Mode

The SBC-6100 Series PV Charge Controller can operate in the several modes. This includes the 3-stage Charge Control, Equalization Charging Mode, DC Load Control Mode, NIGHT-LIGHT mode, Temperature Sensing and Over Temperature Protection features.

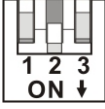
4.1 3-Stage Charge Control

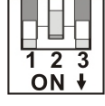
The main function of charge controller is to regulate the flow of electricity from the photovoltaic panels to the batteries. In PV systems with batteries, the batteries must be protected from overcharging and be maintained at fully charged state.

The PV Charge Controller uses the Micro-Processor and PWM (Pulse Width Modulation) to give optimal and safe charging .

It makes varying On-Off pulses of electrical energy from the photovoltaic(PV) panel in charging the battery according to the battery state. It has 3 stages of charging, as follows:

a. BULK CHARGE – At this mode, a preset maximum constant amount of current (amps) is fed into the battery as no PWM is present. As the battery is being charged up , the voltage of the battery increases gradually.

b. ABSORPTION CHARGE – After the preset voltage is reached (approximately 14.3 volts for a 12 volt system) the voltage is then held constant. As the battery continues to be charged at constant voltage, the charging current decreases. The charging voltage is held at the Bulk Voltage Setting for one full hour with various rapid On-Off pulses (PWM). It then switches to Float Charge Mode.

c. FLOAT CHARGE –The controller will maintain the battery voltage at the float voltage setting by giving shorter On-pulse charge to make up for any detected self discharge of the battery. When the battery voltage drops below the Float Voltage Setting for a total period of 5 minutes, a new charging cycle is activated in Bulk Charge.

The three stages charging method works well with the chemical reaction that occurs as a battery is being charged. When a battery is more discharged, a regulated maximum current can be applied, since there is a lot of material available for the reactions to occur.

As the battery refills, less and less chemical material is available for the reaction. By using PWM to slowly reducing the charge current, while maintaining a preset high voltage, the battery is more closely refilled at the reaction rate of the chemicals. Finally, the Float voltage keeps the battery fully charged at all times taking care of the self discharge .

4.2 Equalization Charging Mode (Automatic or Manual)

WARNING: Equalization Charging is only for Wet-type Lead Acid Battery.

The Equalization Charging Voltage is factory pre-set to the Bulk Voltage + 1 Volt.

The battery manufacturer should be consulted. Clean, distilled water will need to be added to the battery AFTER the equalization process.

4.2.1 Automatic Equalization Charging

Automatic Equalization charge is only available when battery voltage is higher than the Low Voltage Disconnect (LVD) voltage , see 4.3.1.

To set Automatic Equalization Charging, set the dip switch 2 to OFF position.

The PV Charge Controller will perform Equalization charging for 2 hours once every 30 days

During equalization charge , it can be stopped any time by pressing the Reset button once and the controller will return to the charging mode before the Equalization charge.

4.2.2 Manual Equalization Charging

Set the Night-Light Mode, dip switch 1 to off position and set the dip switch 2 to ON position.

Press and hold the Reset button for 10seconds and the equalization charge will go on for two hours.

During equalization charge, it can be stopped any time by pressing the Reset button once and the controller will return to the charging mode before the Equalization charge.

4.3 12V DC Load Terminal – Control Mode

The 12V DC load terminal is designed for low power DC load such as street light.

It prevents over-discharging the battery and has 10 Night-Light timer programs.

4.3.1 Low Voltage Disconnect (LVD)

When the battery voltage is lower than the Low Voltage Disconnect (LVD) setting for 5 minutes, the LED will blink orange once every 2 seconds and the load will be cut off. After the load is cut off, user can press the Reset button once to switch on the load for a grace period of 10 minutes for emergency purpose.

4.3.2 Low Voltage Reconnect (LVR)

When the battery voltage is higher than Low Voltage Reconnect (LVR) setting for 5 minutes, the controller will automatically reconnect the load.

4.3.3 NIGHT-LIGHT Mode Programs

In the night-light mode, we have 10 selections.

To Activate the NIGHT-LIGHT Mode, switch the dipswitch 1 to ON position.

Then, use the lighting programmer to select one of the night-light mode selections.(see Table 5)

After activating, when the PV panel voltage is lower than 3.5V for 10 minute, the Controller will turn on the light for a preset period of time according to the option selected.
 When the PV panel voltage is higher than 3.5V for 10minute, the Controller will turn off the light.

In NIGHT-LIGHT Mode, press and hold the Reset button can switch on the Light to test the light.

Also, when the battery is lower than the Low Voltage Disconnect (LVD) for 5 minutes, the load will be cut off.

When the battery voltage becomes higher than Low Voltage Reconnect (LVR) setting for 5 minutes, the controller will automatically reconnect the load again.

The following chart shows the night light mode selections.

LCD Display	Explanation	SUNSET	NIGHT	SUNRISE
OFF	OFF			
2 HR ON	2 HOURS ON			
4 HR ON	4 HOURS ON			
6 HR ON	6 HOURS ON			
8 HR ON	8 HOURS ON			
10 HR ON	10 HOURS ON			
3 / OFF / 1	3 / OFF / 1			
4 / OFF / 2	4 / OFF / 2			
6 / OFF / 2	6 / OFF / 2			
DK--DN	Dusk to Dawn			

Table 5

DESCRIPTION:

OFF – Load remain turned off.

X Hours On – Load is turned on for X hours after sunset.

Y / OFF / Z – Load is turned on for Y hours after sunset, turned off during the night, then turned on again Z hours before sunrise.

Dusk to Dawn – Load is turned on all night.

Measure Night Length

The load timer options that turn the load on again before sunrise require that the PV charge controller to measure the length of the night. The default value of night length is 12 hours after installation (or disconnect then reconnect the battery). The local length of night will take the moving average of 4 consecutive nights.

If the solar array is disconnected during service, the controller will then record premature night duration. This wrong night length data will be outdated after another 4 days of normal service. Alternatively, the above error can be corrected by disconnect then reconnect the battery.

Verify Night-Light Mode selection

To verify the night-light mode selection. During night-light mode, press the reset button once. The green LED will flash once per second. Count these LED flashes to confirm the correct selection.

Each of the 10 night-light mode options has a unique number of flashes. These are as follows:

Switch Setting	# of Flashes
OFF	0
2 Hours On	1
4 Hours On	2
6 Hours On	3
8 Hours On	4
10 Hours On	5
3 / OFF / 1	6
4 / OFF / 2	7
6 / OFF / 2	8
Dusk to Dawn	9

Table 6

Note: Do not press the reset button when the LED is flashing during the verification.

4.4 Temperature Sensor (Optional)

When an external temperature sensor (optional accessory) is installed, the controller will adjust the Bulk and Float Charge Voltage according to the temperature of the battery type. The regulation setpoint is 25°C. The Controller adjusts the BULK and FLOAT setpoints -0.03V/ °C.

Only the factory provided temperature sensor (optional accessory) can be used.

If no temperature sensor is installed, the controller will set the temperature of the battery at 25°C.

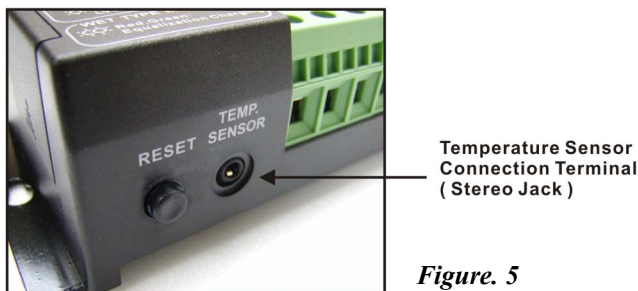

Figure. 5

4.5 Over Temperature Protection

The operation temperature of the transistors of the PV Charge Controller is also continuously monitored. If excessive temperature is detected, the charge controller transistors will repeatedly and rapidly turn On and Off to reduce the charging rate so as to reduce the transistors' temperature. In case the charging current (from the solar panel) is reduced to zero and over temperature condition still persists, the load will also be disconnected.

When the temperature has dropped to the working range, the PV panel and the load will be connected again.

5. Remote Signal Terminal (Optional)

The PV controller has a remote signal output terminal (Optional) which can:

1. control the ON/OFF operation of equipment such as inverter hooked up to the battery bank to operate along with the night-light mode program and share the safeguard function such as low battery disconnect and reconnect.
2. make extension connection of the battery status LED to allow remote monitoring Battery bank status (see Section 3.2)

Activate the feature

Please follow the steps below:

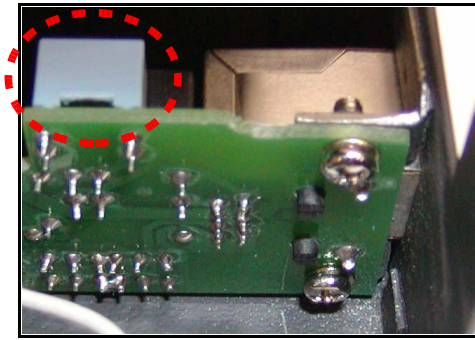

1. Open the case of the controller, there should be a small control board near the Remote Signal Terminal as shown in figure 5.

Figure. 6

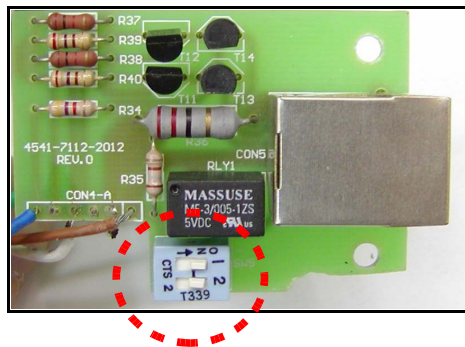

2. On the small control board, there is a sky blue color dip switch. Turn the dip switch 1 and 2 to ON position as shown in figure 6.

Figure. 7

Connection

Use the RJ-45 connector (8-pin) to make extension of Battery status LED and control ON/OFF of the Equipments.

The pins configuration and connection are as follow:

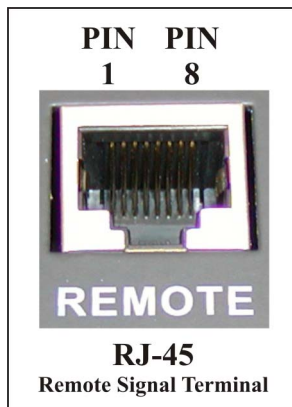

Figure. 8

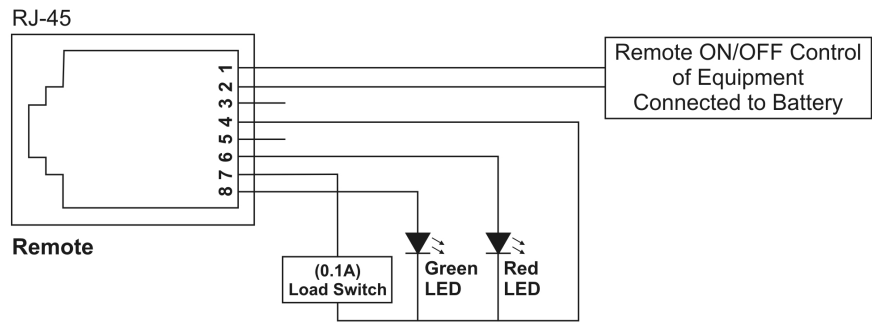

Figure. 9 Connection diagram of RJ-45 to Equipments.

Pin 1 & 2	On/Off Control Signal synchronized with Night-light Mode
Pin 7 & 4	High/Low control signal (12V,0V) up to 0.1A, synchronized with Night Light mode
Pin 6 & 4	Shows the battery status Red LED (See Section 3.2)
Pin 8 & 4	Shows the battery status Green LED (See Section 3.2)

Table 7 Pins configuration

Note: Pin 3 and 5 are not used in Remote Signal Terminal.