

New energy 200 - 1500VDC over wide and over high input voltage isolation converter

FEATURES

- Ultra wide input voltage range: 200 - 1500VDC
- Industrial grade operating temperature: -40°C to +70°C
- 4000VAC high isolation voltage
- High efficiency, Low ripple & noise
- Input under-voltage protection, reverse input voltage protection, Output short circuit, over-current, over-voltage protection
- Meets UL 1741, CSA-C22.2 No.107.1, EN6210 standards (Pending)
- Mounting: PCB mounting, DIN-Rail mounting available



PVxx-29Bxx series —is 200-1500VDC ultra wide input voltage regulated DC-DC converter, which has advantages such as high efficiency, high reliability and high safety isolation. The series products are widely used in industries such as photovoltaic power generation and high voltage frequency conversion, provide a stable operating voltage for the load device. Its multiple protection features can enhance the safety performance of the module power supply and the load under abnormal working conditions. For harsh EMC environment, this series of product must use the referred application circuit.

Selection Guide

Certification	Part No.*	Output Power	Nominal Output Voltage and Current(Vo/Io)	Efficiency (800VDC, %/Typ.)	Max. Capacitive Load(μF) (Normal temperature full load)
CSA/CE (Pending)	PV15-29B05	10W	5V/2000mA	64	6000
	PV15-29B12	15W	12V/1250mA	71	2000
	PV15-29B15		15V/1000mA	72	1200
	PV15-29B24		24V/625mA	74	470
UL/CSA/CE (Pending)	PV40-29B12	40W	12V/3330mA	78	3000
	PV40-29B15		15V/2670mA	82	1500
	PV40-29B24		24V/1670mA	83	680

Note:*Part No. with suffix of "A8""A10" means DIN-Rail mounting (e.g.PV15-29B05A8/ PV15-29B05A10 means DIN-Rail mounting; A8 DIN-Rail package products built-in high-voltage fuse and EMC filter module, meets UL/CSA/CE standards (Pending) (PV40*A8); meets CSA/CE standards (Pending) (PV15*A8); A10 DIN-Rail package products have no high-voltage fuse and EMC filter module, meets UL/CSA/CE standards (Pending) (PV40*A10); meets CSA/CE standards (Pending) (PV15*A10).

Input Specifications

Item	Operating Conditions		Min.	Typ.	Max.	Unit
Input Voltage Range			200	--	1500	VDC
Input current	200VDC	PV15	--	--	120	mA
		PV40	--	--	320	
	800VDC	PV15	--	--	30	
		PV40	--	--	80	
	1500VDC	PV15	--	--	16	
		PV40	--	--	42	
Inrush current	200VDC			--	50	A
	1500VDC			--	150	
Under-voltage protection			Under voltage protection range: 170 - 185V Under voltage release range: 180 - 195V			
External input fuse (A8 Special package series include fuse)			15A/1500VDC, necessary			
Hot Plug			Unavailable			

Output Specifications

Item	Operating Conditions	Min.	Typ.	Max.	Unit
Output Voltage Accuracy		--	±2	--	%
Line Regulation	Full load	--	±1	--	
Load Regulation	0% - 100% load	--	±1	--	
Ripple & Noise*	20MHz bandwidth (peak-peak value)	--	150	300	mV
Temperature Drift Coefficient		--	±0.02	±0.15	%/°C
Short Circuit Protection		Continuous, self-recovery			
Over-current Protection		120% - 320%Io, self-recovery			
Over-voltage Protection	PV15-29B05	≤8VDC			
	PV15-29B12	≤20VDC			
	PV15-29B15	≤20VDC			
	PV15-29B24	≤30VDC			
	PV40-29B12	≤20VDC			
	PV40-29B15	≤20VDC			
	PV40-29B24	≤30VDC			
Min. Load		0	--	--	%
Delay Time**	200 - 1500VDC	--	--	3	s

Note: * Ripple and noise are measured by "parallel cable" method, please see AC-DC Converter Application Notes for specific operation.
 **Delay Time test condition: Full input voltage range, full output load range (The cooling time between Input power-off and the next input Power-on is bigger than 15s).

General Specifications

Item	Operating Conditions	Min.	Typ.	Max.	Unit	
Isolation Voltage	Input-output Test time: 1min	4000	--	--	VAC	
Operating Temperature		-40	--	+70	°C	
Storage Temperature		-40	--	+85		
Storage Humidity		--	--	95	%RH	
Welding Temperature	Wave-soldering	260 ± 5°C; time: 5 - 10s				
	Manual-welding	360 ± 10°C; time: 3 - 5s				
Power Derating	-40°C to 0°C (200 - 300VDC)	PV15-29B05/12/15	0.75	--	--	% / °C
		PV15-29B24/ PV40-29Bxx	1.5	--	--	
	-40°C to -15°C (1000 - 1500VDC)	PV15-29Bxx	1.2	--	--	
		PV40-29Bxx	0	--	--	
	+50°C to +70°C	PV15-29Bxx	1.5	--	--	
	PV40-29Bxx	2.5	--	--		
Switching Frequency		--	65	--	kHz	
Safety Standard		UL 1741, CSA-C22.2 No.107.1, EN62109				
Safety Certification		UL 1741, CSA-C22.2 No.107.1, EN62109 Pending)				
Altitude		--	--	5000	m	
MTBF		MIL-HDBK-217F@25°C ≥ 300,000 h				

Physical Specifications

Casing Material		Black flame-retardant and heat-resistant plastic (UL94 V-0)	
Dimensions	Horizontal package	125.00*75.00*40.00 mm	
	A8 Din-Rail mounting	146.00*138.00*55.00 mm	
	A10 Din-Rail mounting	129.00*102.00*49.00 mm	
Weight	Horizontal package	PV15	400g (Typ.)
		PV40	434g (Typ.)
	A8 Din-Rail mounting	PV15	710g (Typ.)
		PV40	744g (Typ.)
	A10 Din-Rail mounting	PV15	460g (Typ.)
		PV40	494g (Typ.)
Cooling method	Free air convection		

Note: Avoid washing the shell with the PCB water directly, We recommend to use alcohol to clean or wipe it.

EMC Specifications

EMI	CE	CISPR32/EN55032	CLASS A(See Fig. 2 for recommended circuit)	
	RE	CISPR32/EN55032	CLASS A(See Fig. 2 for recommended circuit)	
EMS	ESD	IEC/EN61000-4-2	Contact ±6KV/Air ±8KV	Perf. Criteria B
	RS	IEC/EN61000-4-3	10V/m	perf. Criteria A
	EFT	IEC/EN61000-4-4	±2KV (See Fig. 2 for recommended circuit)	perf. Criteria B
	Surge	IEC/EN61000-4-5	line to line±1KV (See Fig. 2 for recommended circuit)	perf. Criteria B
	CS	IEC/EN61000-4-6	10Vr.m.s	perf. Criteria A
	PFM	IEC/EN61000-4-8	10A/m	perf. Criteria A

Note: A8 meet the above EMC performance, no external recommended circuit.

Product Characteristic Curve

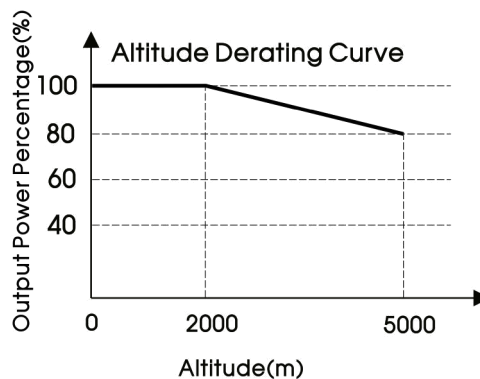
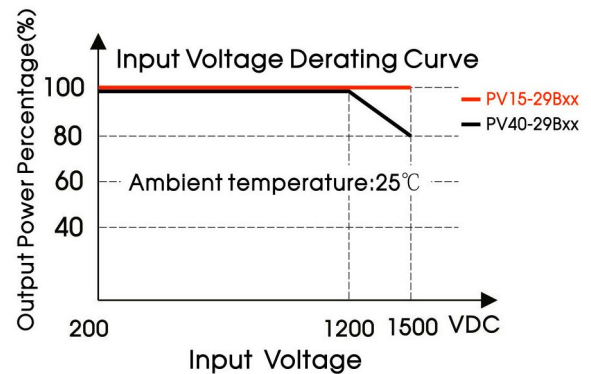
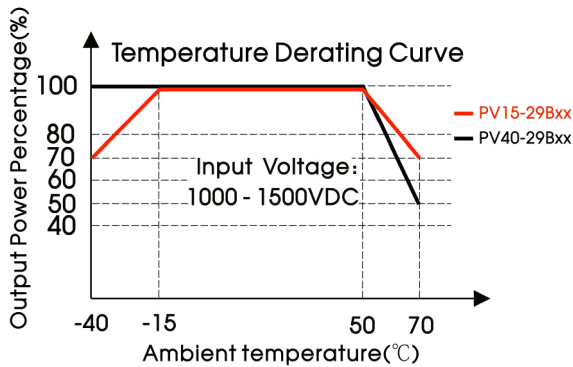
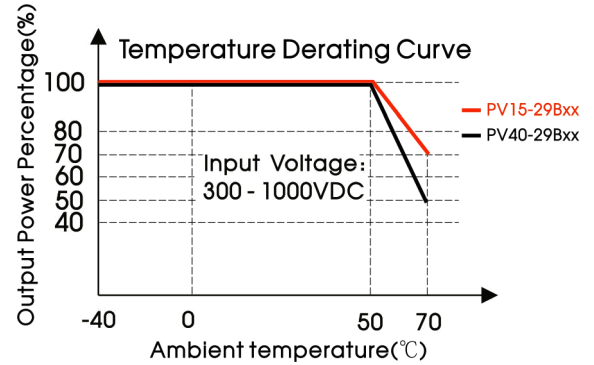
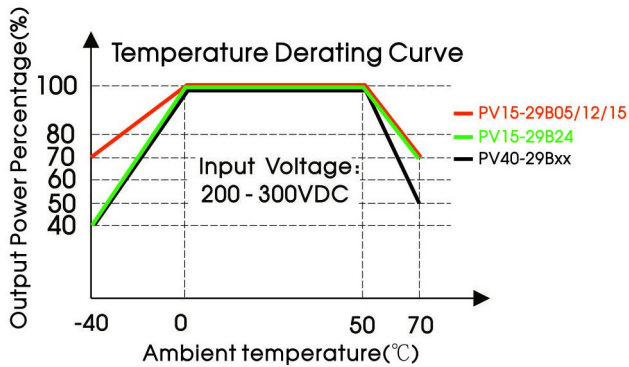

Note:

- ① For the PV40-29BXX, input voltage should be derated based on temperature derating when it is 1200 - 1500VDC;
- ② For the PVxx-29Bxx, altitude should be derated based on temperature derating when it is 2000 - 5000m;
- ③ This product is suitable for use in natural air cooling environments, if in a closed environment, please contact our company's FAE.

Design Reference

1. Typical application circuit

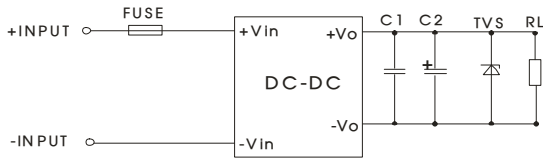

Fig. 1: Typical application circuit

Model	C1(μF)	C2(μF)	TVS tube
PV15-29B05	1	120	SMBJ7.0A
PV15-29B12		120	SMBJ20A
PV15-29B15		120	SMBJ20A
PV15-29B24		68	SMBJ30A
PV40-29B12		120	SMBJ20A
PV40-29B15		120	SMBJ20A
PV40-29B24	68	SMBJ30A	

Note:
Output filtering capacitor C2 is electrolytic capacitor, it is recommended to apply electrolytic capacitor with high frequency and low resistance. For capacitance and current of capacitor please refer to manufacture's datasheet. Capacitor voltage reduced to at least 80%. C1 is ceramic capacitor, which is used to filter high-frequency noise. TVS is a recommended component to protect post-circuits if converter fails.

2. EMC solution-recommended circuit

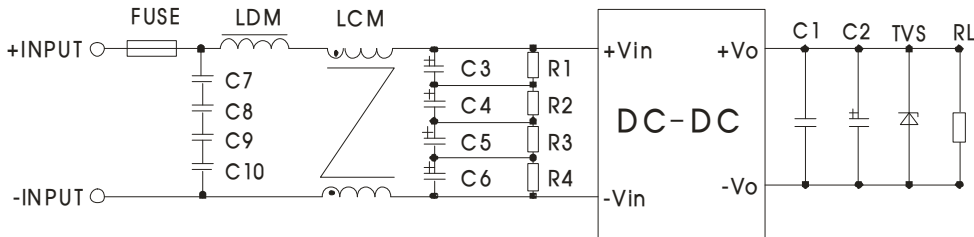
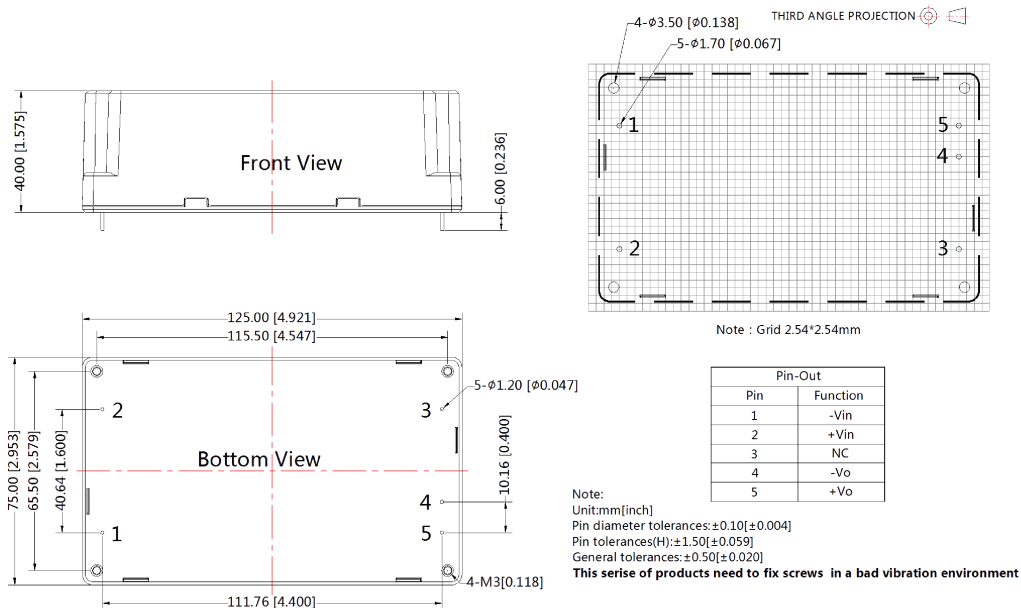

Fig 2: EMC application circuit with higher requirements (The output circuit parameters show in Figure 1)

Element model	Recommended value
C7/C8/C9/C10	Safety capacitor 104K/275VAC
C3/C4/C5/C6	47uF/450VDC
R1/R2/R3/R4	1MΩ /2W
LDM	330uH/1A
LCM	7mH/1A
FUSE	15A/1500VDC, necessary

3. For more information Please find the application notes on www.mornsun-power.com

Dimensions and Recommended Layout



A8 Dimensions

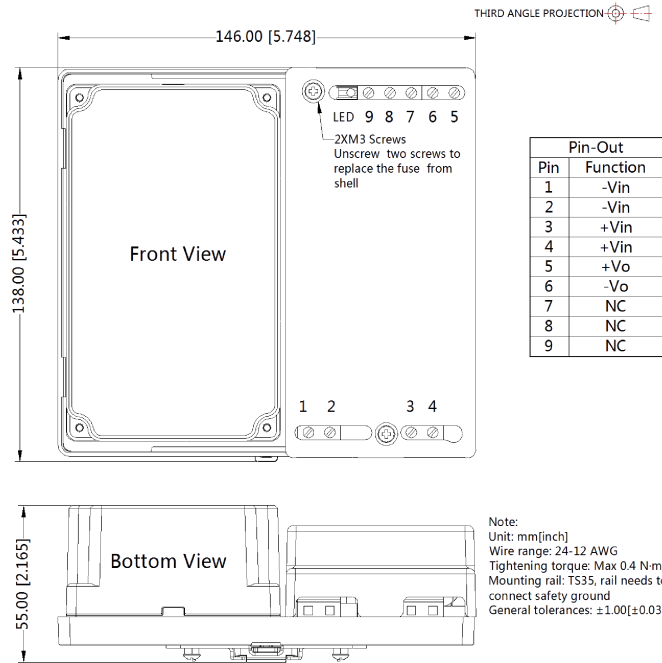

A10 Dimensions

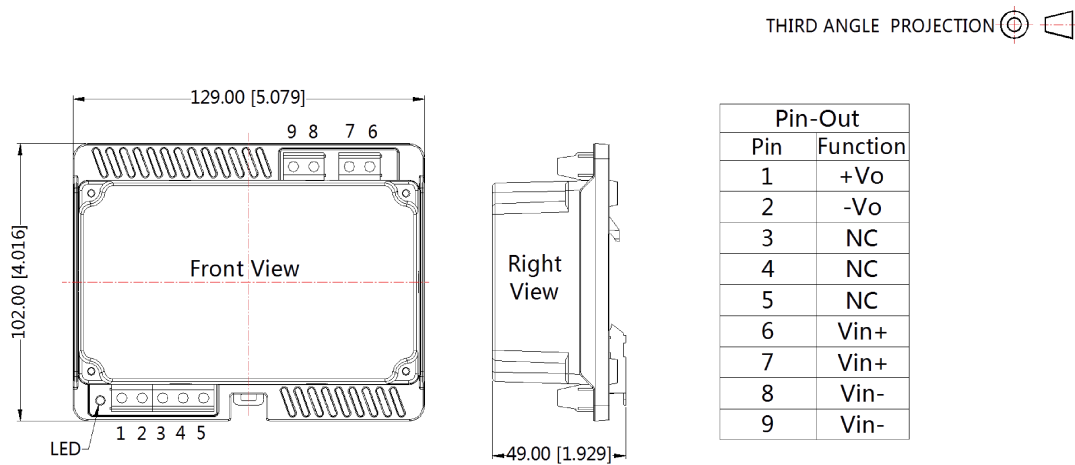

Note:
Unit: mm[inch]
Wire range: 24-12 AWG
Tightening torque: Max 0.4 N·m
Mounting rail: TS35, rail needs to connect safety ground
General tolerances: ±1.00[±0.039]

Note:

1. Packing information please refer to Product Packing Information which can be downloaded from www.mornsun-power.com. Packing bag number of Horizontal package: 58020023; the Packing bag number of A8package: 58220034 ; the Packing bag number of A10 package: 58220040;
2. Unless otherwise specified, A8/A10 products performance are consistent with Horizontal package products;
3. Unless otherwise specified, data in this datasheet should be tested under the conditions of $T_a=25^{\circ}\text{C}$, humidity<75% when inputting nominal voltage and outputting rated load;
4. All index testing methods in this datasheet are based on our Company's corporate standards;
5. In order to improve the conversion efficiency, when the module is working under high pressure, the module may have certain audio noise, but does not affect the reliability of the product;
6. It is recommended that the product be locked screw before welding;
7. If you need to replace the fuse of A8 package products, please be careful, don't allow the bottom of PCB board to bear excessive mechanical stress;
8. The performance indexes of the product models listed in this manual are as above, but some indexes of non-standard model products will exceed the above-mentioned requirements, and please directly contact our technician for specific information;
9. We can provide product customization service;
10. Products are related to laws and regulations: see "Features" and "EMC";
11. Our products shall be classified according to ISO14001 and related environmental laws and regulations, and shall be handled by qualified units.

Mornsun Guangzhou Science & Technology Co., Ltd.

Address: No. 5, Kehui St. 1, Kehui Development Center, Science Ave., Guangzhou Science City, Luogang District, Guangzhou, P. R. China
Tel: 86-20-38601850-8801 Fax: 86-20-38601272 E-mail: info@mornsun.cn