



## Description

PT 2272 is a remote control decoder paired with PT 2262 utilizing CMOS Technology. It has 12 bits of tri-state address pins providing a maximum of 531,441 (or  $3^{12}$ ) address codes; thereby, drastically reducing any code collision and unauthorized code scanning possibilities. PT 2272 is available in several options to suit every application need : variable number of data output pins, latch or momentary output type.

## Features

- CMOS Technology
- Low Power Consumption
- Very High Noise Immunity
- Up to 12 Tri-State Code Address Pins
- Up to 6 Data Pins
- Wide Range of Operating Voltage:  $V_{cc} = 4 \sim 15$  Volts
- Single Resistor Oscillator
- Latch or Momentary Output Type
- Available in DIP and SO Package

## Applications

- Car Security System
- Garage Door Controller
- Remote Control Fan
- Home Security/Automation System
- Remote Control Toys
- Remote Control for Industrial Use



# Pin Configuration

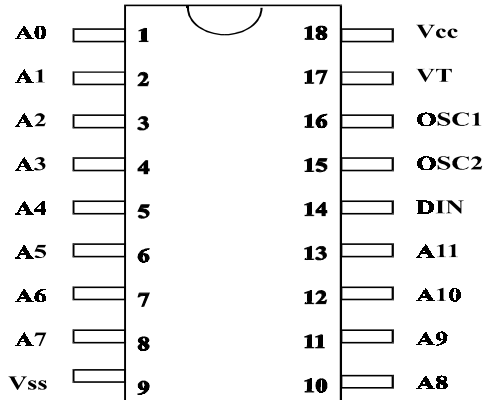

**PT 2272**

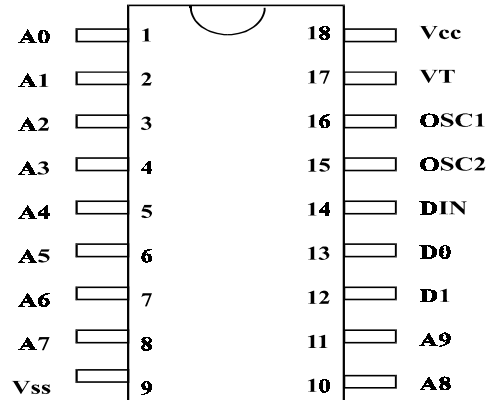

**PT 2272A - M2/L2**

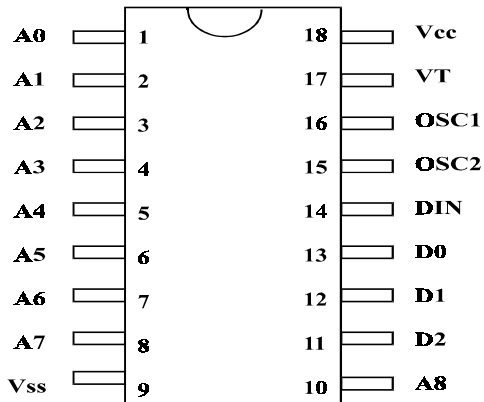

**PT 2272 - M3/L3**

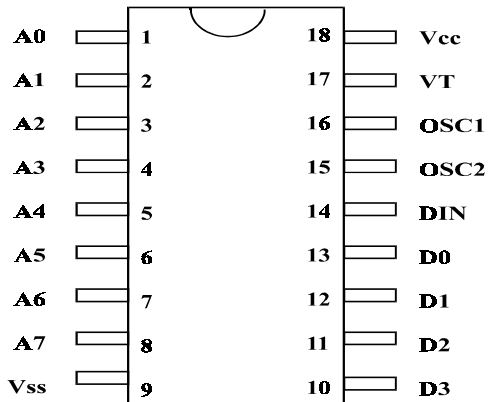

**PT 2272 - M4/L4**

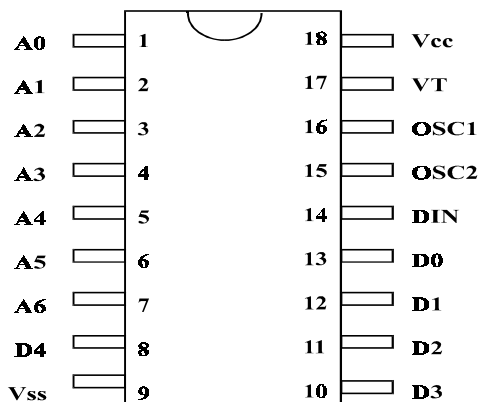

**PT 2272 - M5/L5**

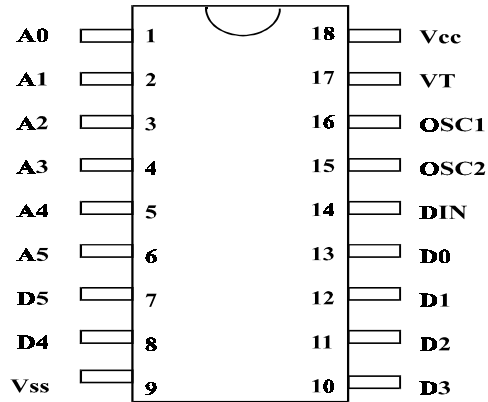

**PT 2272 - M6/L6**



Remote Control Decoder

PT 2272

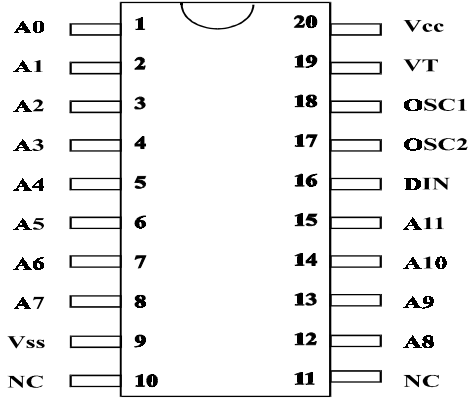

PT 2272 (20 Pins)

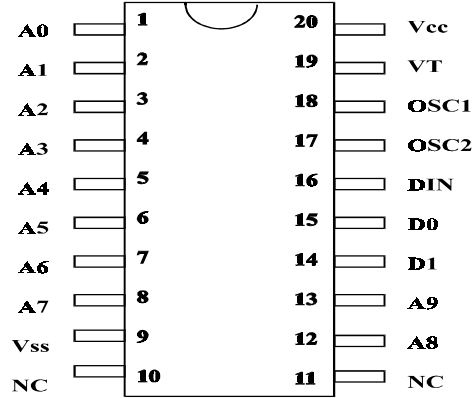

PT 2272A - M2/L2 (20 Pins)

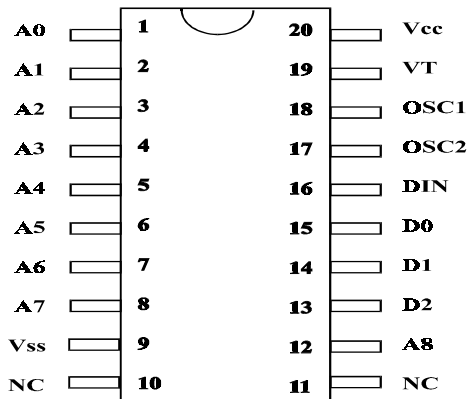

PT 2272 - M3/L3 (20 Pins)

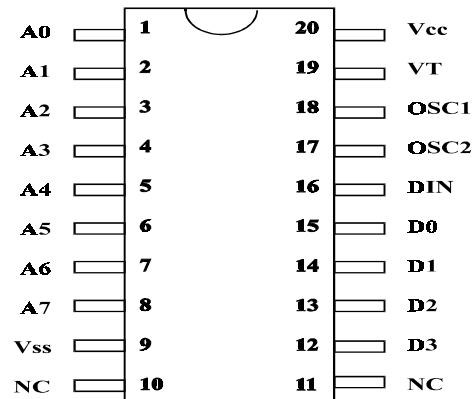

PT 2272 - M4/L4 (20 Pins)

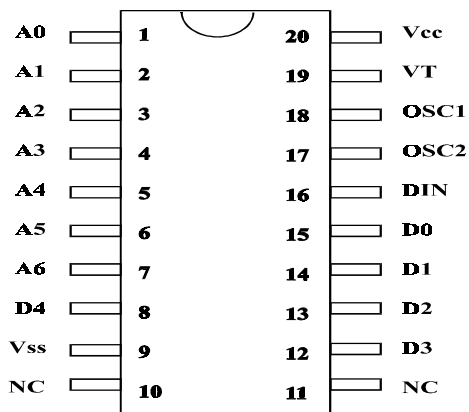

PT 2272 - M5/L5 (20 Pins)

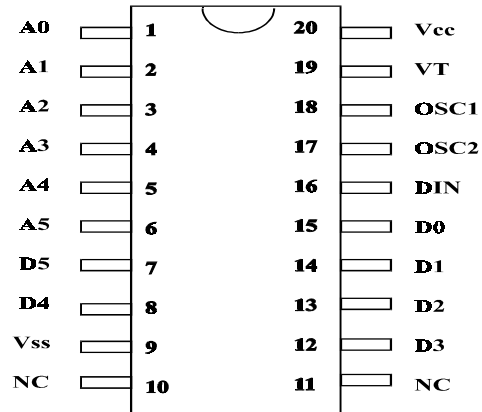

PT 2272 - M6/L6 (20 Pins)





*PT2272 (4 Data) RF Application Circuit*

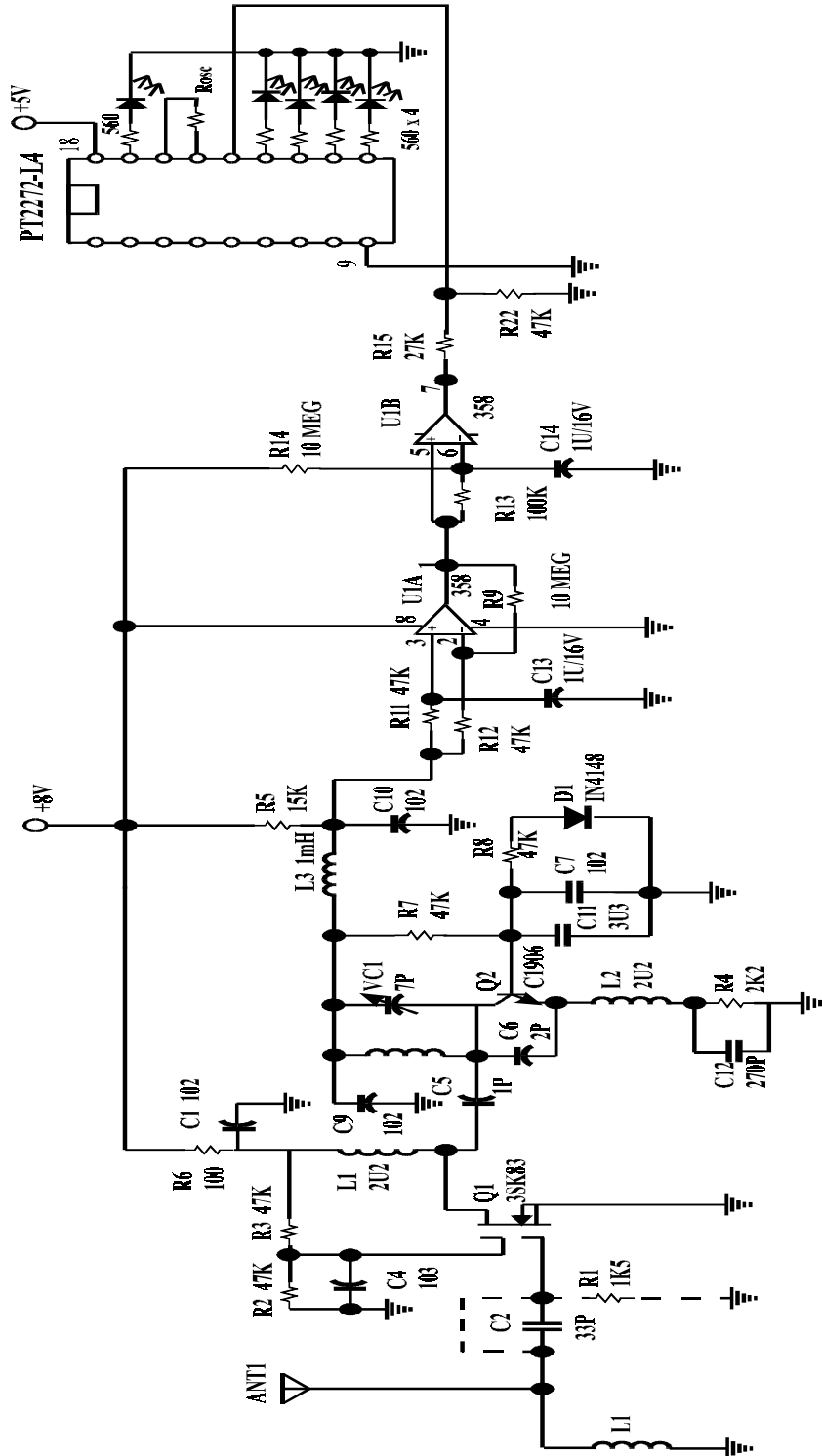



***PT2272 (4 Data) IR Application Circuit***

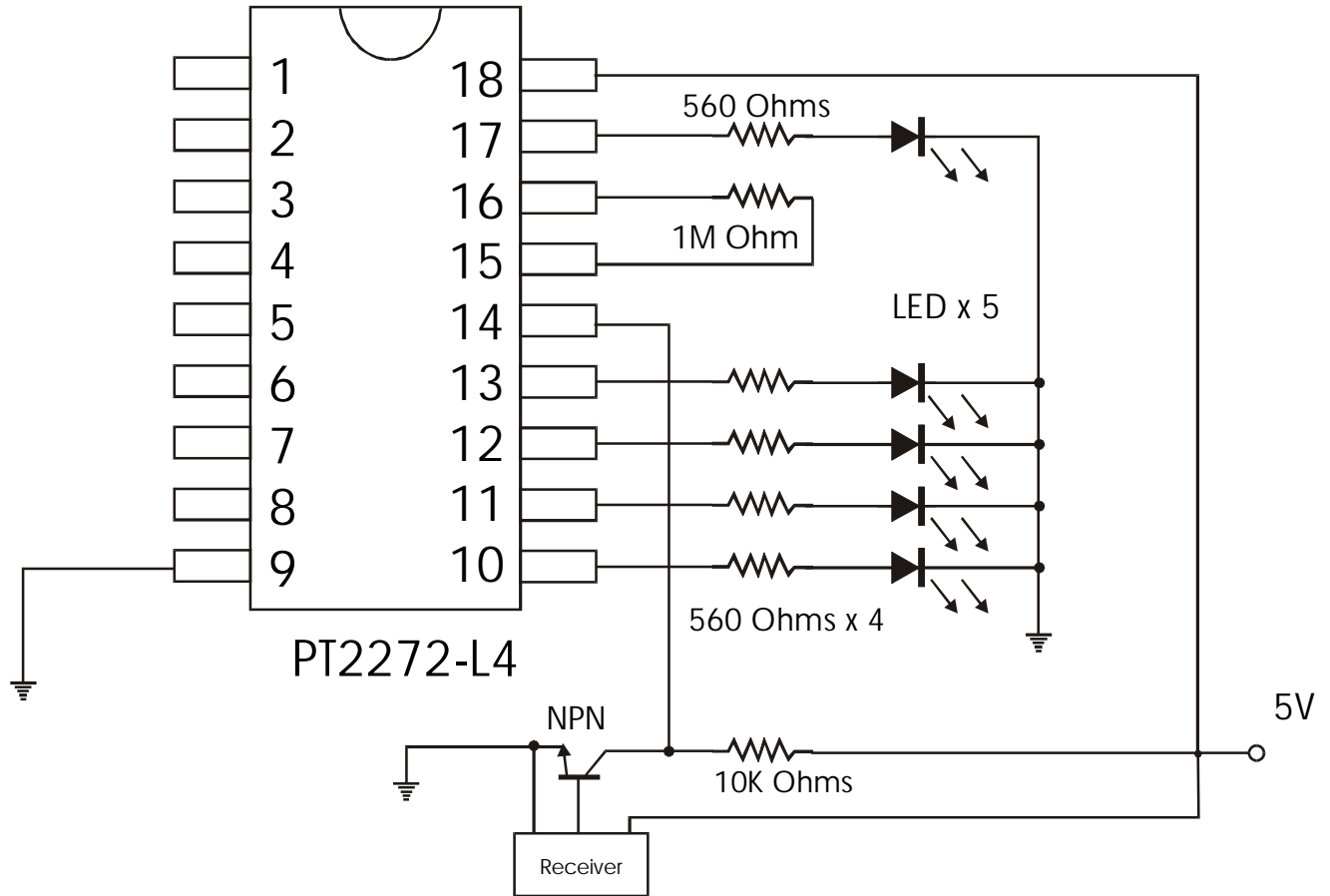



## Ordering Information

### A. 18-Pin Package:

Part No.	Data Bit(s)	Output Type	Package
PT2272 (-S18)	None	*	DIP (SO)
PT2272A-L2 (-S18)	2	Latch	DIP (SO)
PT2272A-M2 (-S18)	2	Momentary	DIP (SO)
PT2272-L3 (-S18)	3	Latch	DIP (SO)
PT2272-M3 (-S18)	3	Momentary	DIP (SO)
PT2272-L4 (-S18)	4	Latch	DIP (SO)
PT2272-M4 (-S18)	4	Momentary	DIP (SO)
PT2272-L5 (-S18)	5	Latch	DIP (SO)
PT2272-M5 (-S18)	5	Momentary	DIP (SO)
PT2272-L6 (-S18)	6	Latch	DIP (SO)
PT2272-M6 (-S18)	6	Momentary	DIP (SO)

### B. 20-Pin Package

Part No.	Data Bit(s)	Output Type	Package
PT2272-S	None	*	SO
PT2272A-L2S	2	Latch	SO
PT2272A-M2S	2	Momentary	SO
PT2272-L3S	3	Latch	SO
PT2272-M3S	3	Momentary	SO
PT2272-L4S	4	Latch	SO
PT2272-M4S	4	Momentary	SO
PT2272-L5S	5	Latch	SO
PT2272-M5S	5	Momentary	SO
PT2272-L6S	6	Latch	SO
PT2272-M6S	6	Momentary	SO

Note: \* = use VT (Valid Transmission)



PT 2272 X - X X X

