



**LONG LIFE TIPS TO REPLACE WELLER'S LT SERIES TIPS**

- Longer life
- Designed for lead-free soldering
- Look for tips with an LF added to the end of the part number

Weller®	Plato® Tip	Tip drawings are actual size.		Weller®	Plato® Tip	Tip drawings are actual size.	
—	MS-4140		.031" (0.8)	LTD LF	<b>NEW!</b> MS-3600 LF		.181" (4.6)
LT1	MS-4120		.010" (0.25)	LTGW	MS-0100		.122" (3.1) / .084" (2.1)
LT1L	MS-4110		.010" (0.25)	LTGW LF	<b>NEW!</b> MS-0100 LF		.122" (3.1) / .084" (2.1)
LT1LX	MS-4101		.010" (0.25)	LTH	MS-3110		.031" (0.8)
LT1S	MS-4100		.063" (1.6)	LTHX	MS-3101		.024" (0.6)
LT4W	MS-5160		.047" (1.2)	LTK	MS-3150		.050" (1.3)
LT4X	MS-3125		0.085" (2.1) / 0.047" (1.2)	LTL	MS-3250		.079" (2.0)
LTA	MS-3200		.063" (1.6)	LTM	MS-3450		.125" (3.2)
LTA LF	<b>NEW!</b> MS-3200 LF		.063" (1.6)	LTS	MS-4130		.018" (0.5)
LTB	MS-3300		.094" (2.4)	LTO LF	<b>NEW!</b> MS-4200 LF		0.039" (0.9)
LTB LF	<b>NEW!</b> MS-3300 LF		.094" (2.4)	LTBB LF	<b>NEW!</b> MS-5300 LF		0.094" (2.4)
LTC	MS-3400		.125" (3.2)	LTCC LF	<b>NEW!</b> MS-5400 LF		0.125" (3.2)
LTC LF	<b>NEW!</b> MS-3400 LF		.125" (3.2)	LTKN LF	<b>NEW!</b> MS-0201-LF		0.162" (4.0) / 0.228" (5.7)
LTD	MS-3600		.181" (4.6)				0.002" (0.05) / 0.06" (1.5)

Be sure to add temperature indicating number to Plato® part number when ordering Plato® C-Tips.

Choose the desired temperature and add it to the end of the Plato part number\* (Example C-3039-7)



Desired Temperature	Suffix to Add to Plato Part Number
700° F / 370° C	-7
800° F / 425° C	-8
900° F / 480° C	-9



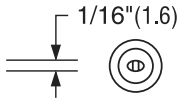
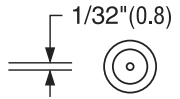
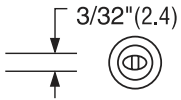
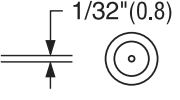
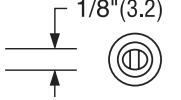
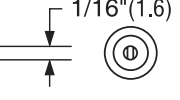
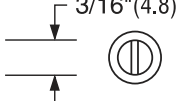
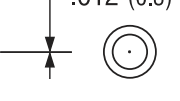
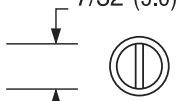
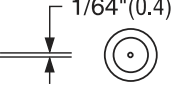

Weller®	Plato® Tip	Tip drawings are actual size.	Weller®	Plato® Tip	Tip drawings are actual size.
PTA	C-3039		PTP	C-462	
PTB	C-3040		PTR	C-1021	
PTC	C-3036		---	C-4794	
PTD	C-1016		PTS	C-494	
PTE	C-1017		PTT	C-4309	
PTF	C-593		PTAA	C-5139	
PTH	C-3100		PTBB	C-5143	
PTJ	C-3865		PTCC	C-5141	
PTK	C-3043		PTDD	C-5142	
PTL	C-3044				
PTM	C-3102				
PTO	C-4223				

\* Indicated temperature ranges are nominal and will vary according to style of tip, condition of iron, manner of use, and other variables.

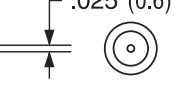
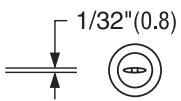
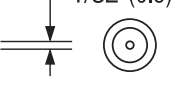
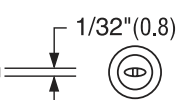
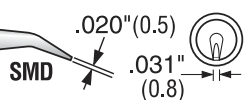
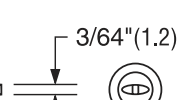
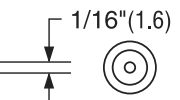
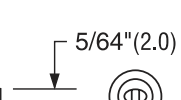
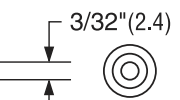
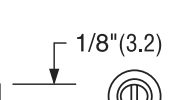
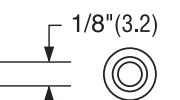



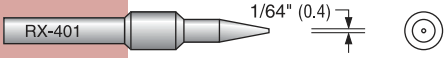

All dimensions are shown before tinning and are subject to manufacturing tolerances.

All points are 1/32" (0.8) thick unless otherwise noted.  
Tip samples available. ( ) = mm



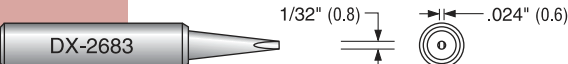
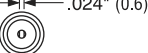

Weller®	Plato® Tip	Tip drawings are actual size.	Weller®	Plato® Tip	Tip drawings are actual size.
ETA	EW-303		ETO	EW-404	
ETB	EW-305		ETP	EW-403	
ETC	EW-307		ETR	EW-101	
ETD	EW-103			EW-4796	
ETE	EW-105		ETS	EW-402	
ETGW	EW-0574		ETT	EW-401	
ETH	EW-301		ETV	EW-511	
ETJ	EW-302			EW-0602	
ETK	EW-304		ETAA	EW-513	
ETL	EW-306		ETBB	EW-515	
ETM	EW-308		ETCC	EW-517	

Weller®	Plato® Tip	Tip drawings are actual size.
EPH101	RX-4762 	
EPH110	RX-401 	

Micro Soldering Pencil • MLR 20 • MPR 30

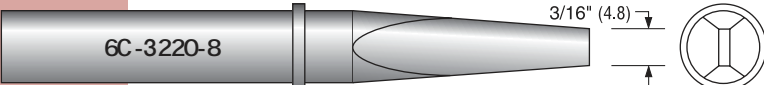
Weller®	Plato® Tip	Tip drawings are actual size.
MPT-1	DX-4771 	
MPT-1S	DX-4814 	
MPT-H	DX-2683 	
	DX-4977 	

Soldering Iron • W100PG

Weller®	Plato® Tip	Tip drawings are actual size.
CT6D8	6C-3220-8 	
CT6F8	6C-1083-8 	

Hakko®	Plato® Tip	Tip drawings are actual size.
900MT-0.5C	HS-5715	.019" (0.5)
900MT-1C	HS-5701	3/64" (1.2)
900MT-2C	HS-5702	5/64" (2.0)
900MT-3C	HS-5703	1/8" (3.0)
900MT-4C	HS-5875	5/32" (4.0)
900MT-3CF	HS-5864	.118" (3.0) Tin on flat only
900MT-0.8D	HS-2863	1/32" (0.8)
900MT-1.2D	HS-2796	3/64" (1.2)
900MT-1.2LD	HS-6030	3/64" (1.2)
900MT-1.6D	HS-2751	1/16" (1.6)
900MT-2.4D	HS-2752	3/32" (2.4)
900MT-3.2D	HS-2753	1/8" (3.2)
900MT-Q.2RB	HS-4791	0.016" (0.4)

Hakko®	Plato® Tip	Tip drawings are actual size.
900MT-1.8H	HS-0926	20° 0.04" (1.0)
900MT-H	HS-0925	30° 1/16" (1.6)
900MT-B	HS-4785	.040" (1.0) .250" TIN LENGTH
	HS-8179	.040" (1.0) .300" TIN LENGTH
900MT-LB	HS-4786	1/64" (0.4)
900MT-1	HS-4787	1/64" (0.8)
900MT-K	HS-0927	3/16" (4.7) 1/4" (6.3)
900MT-S1	HS-2796	3/64" (1.2)
900MT-S3	HS-1665	13/64" (5.2)
900MT-S4	HS-8175	.008" (0.2)
900MT-S5	HS-8157	1/64" (0.4)
SMD Flow Tip	HS-0530	.128" (3.3) .118" (3.0)
SMD Flow Tip	HS-0531	.195" (5.0) .135" (3.4)