

AXIAL WIREWOUND RESISTORS AC

FEATURES

- General purpose resistors;
- High power dissipation in small volume;
- High pulse load handling capabilities;
- Different forming styles available;
- High temperature silicone coating.



MARKET SEGMENTS AND APPLICATIONS

Market Segment	Application
Industrial	Power supplies Motor speed controls
Telecom	Line protection resistor Power supplies
Consumer Sound & Vision	Audio Editors Systems High end hi-fi
DAP	Kitchen appliances White good
Lighting	Ballast equipment
Automotive	Dashboard electronics Electronic fuel injection

TECHNOLOGY

The resistor element is a resistive wire, which is wound, in a single layer on a ceramic rod. Metal caps are pressed over the ends of the rod. The ends of the resistance wire and the leads are connected to the caps by welding. Tinned copper-clad iron leads with poor heat conductivity are employed permitting the use of relatively short leads to obtain stable mounting without overheating. The resistor is coated with green silicon cement which is non-flammable, will not drip even at high overloads and is resistant to most commonly used cleaning solvents, in accordance with "MIL-STD-202E, method 215" and "IEC 60068-2-45". The standard resistor is supplied with axial lead taped or with formed leads as a special type.

QUICK REFERENCE DATA

DESCRIPTION	AC01	AC03	AC04	AC05	AC07	AC10	AC15	AC20
Rated dissipation at $T_{amb}=40\text{ °C}$	1W	3W	4W	5W	7W	10W	15W	20W
Rated dissipation at $T_{amb}=70\text{ °C}$	0.9W	2.5W	3.5W	4.7W	5.8W	8.4W	12.5W	16.0W
Resistance range (E24 Series), (see note 1)	0.1Ω to 2.4kΩ	0.1Ω to 5.1kΩ	0.1Ω to 6.8kΩ	0.1Ω to 8.2kΩ	0.1Ω to 15kΩ	0.68Ω to 27kΩ	0.82Ω to 39kΩ	1.2Ω to 56kΩ
Resistance tolerance (see note 2)	±5%; (see note 2)							
Maximum permissible body temperature	350°C							
Temperature coefficient	values <10Ω: +600 ppm/°C ; values ≥10Ω: -80/+140 ppm/°C (See note. 3)							
Climatic category (IEC 60 068)	40/200/56							
Operator Temperature	-40°C to + 200°C							
Basic specification	IEC 60 115-1							
Limit voltage	$V = \sqrt{P_n \times R}$							
Stability after : Load, 1000 hours Soldering Climatic tests Short time overload	$\Delta R/R_{max}:$ ±5% +0.1Ω $\Delta R/R_{max}:$ ±0.5% +0.05Ω $\Delta R/R_{max}:$ ±1% +0.05Ω $\Delta R/R_{max}:$ ± 2% +0.1Ω							
Special product modifications available on request								
Note 1	Special resistive values; Low inductance styles							
Note 2	Tolerances.: 1% 3% 10%							
Note 3	Temperature coefficient (ppm/°C):. 30 / 50 / 90							
Note 4	Terminal lengths and diameters							
Note 5	Terminal with special configuration cropped and formed, double kink, stand-up version etc.							
Application information available on request								
1 - Pulse load behaviour								
2 - High frequency behaviour (self inductance)								

MECHANICAL DATA

Axial style

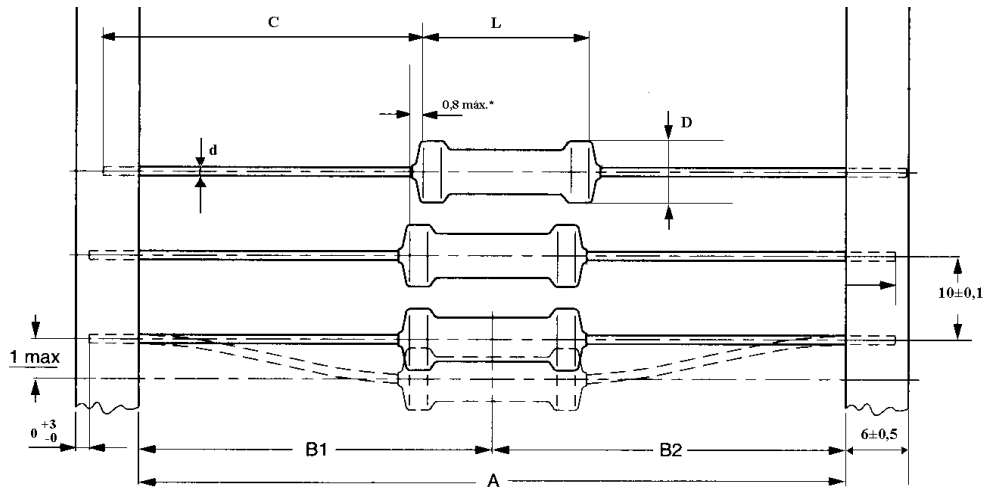

* Max. displacement between any two resistors.

TYPE	L max.	D max.	C	D	B1-B2	A
AC01	10 (0.394)	4.3 (0.169)	32 (1.260)	0.8 ± 0.03 (0.031 ± 0.001)	± 1.2 (0.047)	63 ± 2 (2.480 ± 0.079)
AC03	13 (0.512)	5.5 (0.216)	30 (1.181)		± 1.2 (0.047)	63 ± 2 (2.480 ± 0.079)
AC04	17 (0.669)	5.7 (0.224)	28 (1.102)		± 1.2 (0.047)	63 ± 2 (2.480 ± 0.079)
AC05	17 (0.669)	7.5 (0.295)	28 (1.102)		± 1.2 (0.047)	63 ± 2 (2.480 ± 0.079)
AC07	25 (0.984)	7.5 (0.295)	28 (1.102)		± 1.2 (0.047)	73 ± 2 (2.874 ± 0.079)
AC10	44 (1.732)	8 (0.315)	28 (1.102)		± 1.2 (0.047)	89 ± 2 (3.504 ± 0.079)
AC15	51 (2.008)	10 (0.394)	28 (1.102)		-	-
AC20	67 (2.638)	10 (0.394)	28 (1.102)		-	-

Dimensions in mm (inches).

Terminal forming types available under request

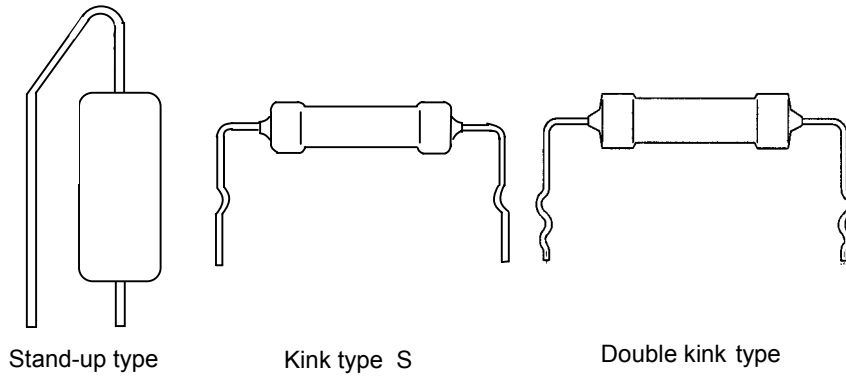

The dimension for leads forming to be define as a function of specific application.

Radial tapped version (available for AC01 type)

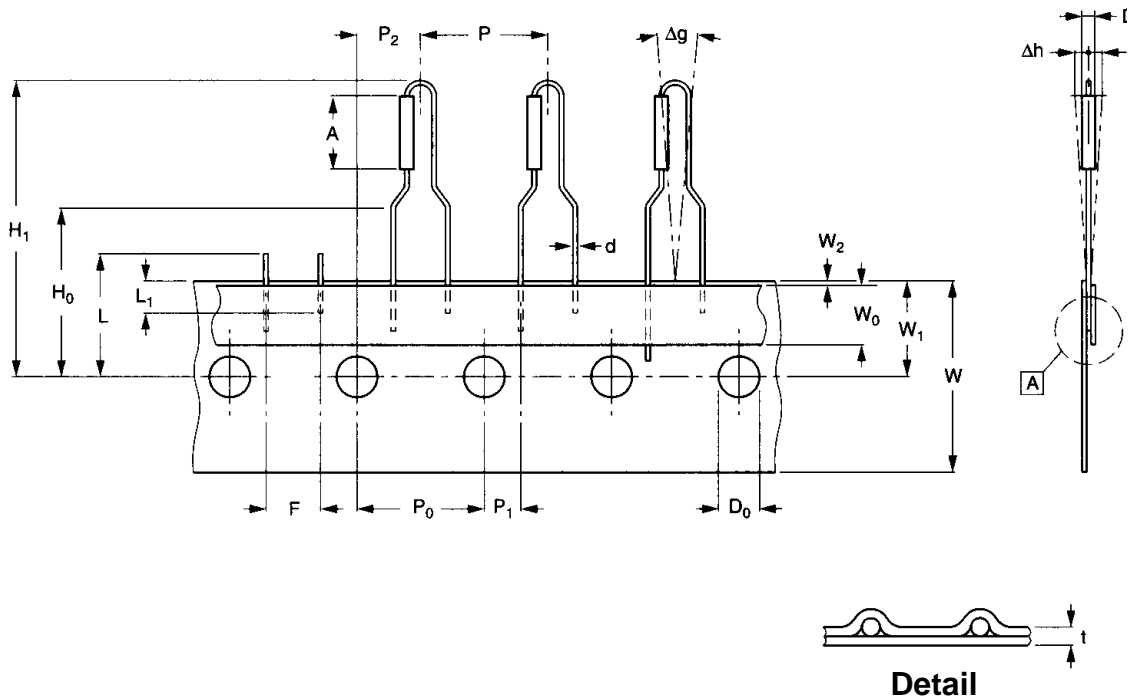

Parameter	Symbol	Dimensions	Tolerance	Notes
Maximum body diameter	D	4.1 (0.161)	Máx.	
Maximum body length	A	8.5 (0.335)	Máx.	
Lead wire diameter	d	0.8 (0.031)	+ 0.06 / -0.05 (+0.002 / - 0.002)	
Pitch of components	P	12.7 (0.500)	± 1.0 (0.039)	
Feed hole pitch	P ₀	12.7 (0.500)	± 0.2 (0.008)	
Pitch error max.	-	1.0 (0.039)	-	In 20 spacing
Feed-hole centre to lead at topside at the tape	P ₁	3.85 (0.151)	± 0.5 (0.002)	
Feed hole centre to body centre	P ₂	6.35 (0.250)	± 1.0 (0.039)	
Lead-to-lead distance	F	5.0 (0.197)	+ 0.5 / - 0.2 (+0.002 / -0.008)	
Component alignment	Δh	0	± 1.2 (0.047)	
Component alignment	Δg	0	± 3°	
Tape width	W	18.0 (0.709)	± 0.5 (0.002)	
Minimum hold down tape width	W ₀	6.0 (0.236)	+ 0.2 / - 0.5 (+0.008 / - 0.002)	
Hole position	W ₁	9.0 (0.354)	± 0.5 (0.002)	
Maximum hold down tape position	W ₂	0.5 (0.020)	Máx.	
Lead wire	H ₀	16.5 (0.650)	± 0.5 (0.020)	
Height of component from tape centre	H ₁	32.0 (1.260)	Máx.	23min
Feed hole diameter	D ₀	4.0 (0.157)	± 0.2 (0.008)	
Total tape thickness	T	0.9 (0.035)	Máx.	0.4min
Maximum length of snipped lead	L	11.0 (0.433)	Máx.	
Minimum lead wire (tape portion) shortest lead.	L ₁	2.5 (0.098)	Mín.	

Dimensions in mm (Inches).

ELETRICAL CHARACTERISTICS

DERATING

The power that the resistor can dissipates depends on the operating temperature; see bellow.

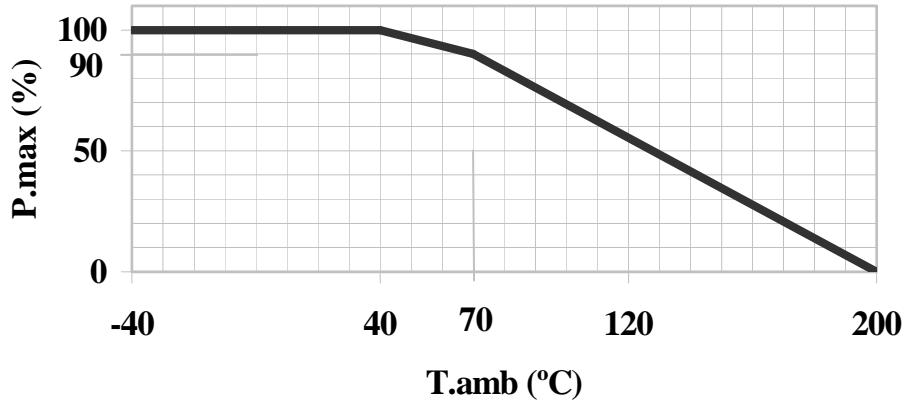

Temperature rise of the resistor body as a function of the dissipation

APPLICATION INFORMATION

HOT SPOT

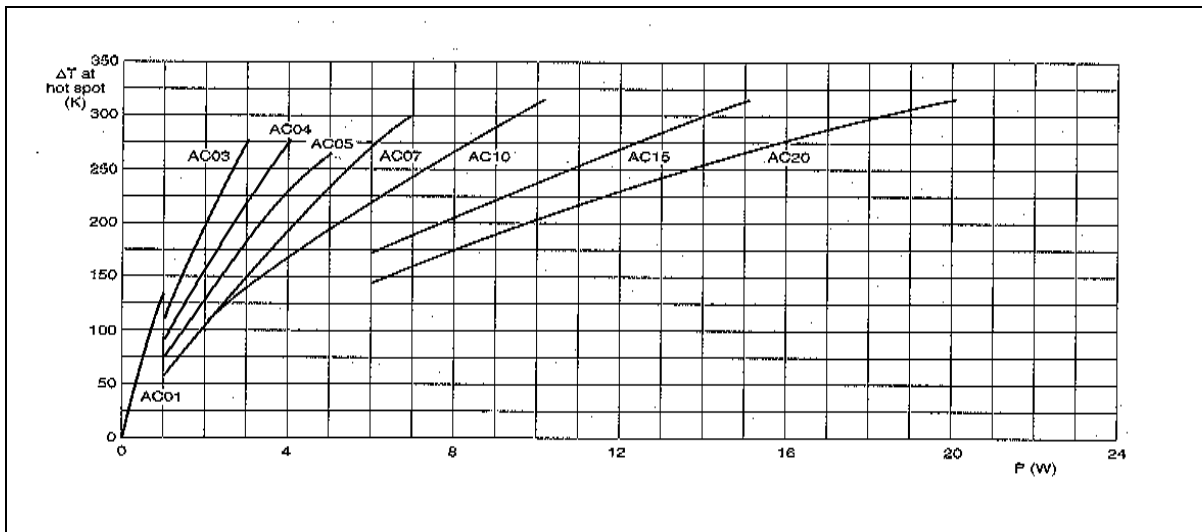

Hot Spot temperature rise (ΔT) as a function of dissipated power.

SOLDER SPOT

Lead length as a function of the dissipation with the temperature rise at the end of lead (soldering oint)

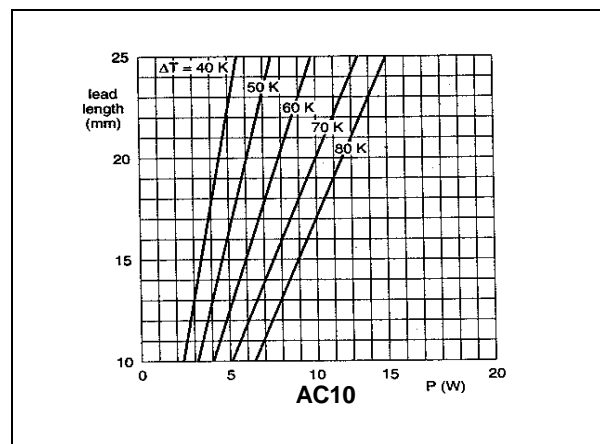
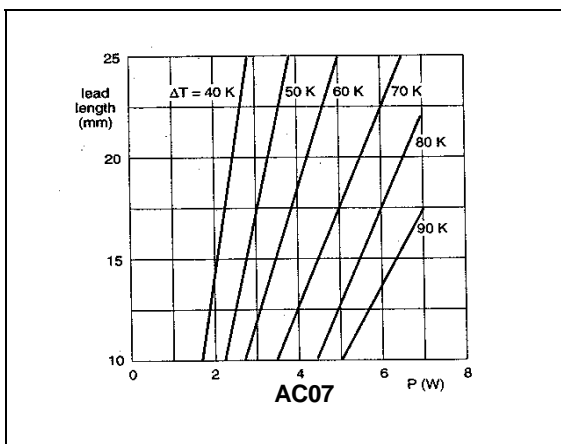
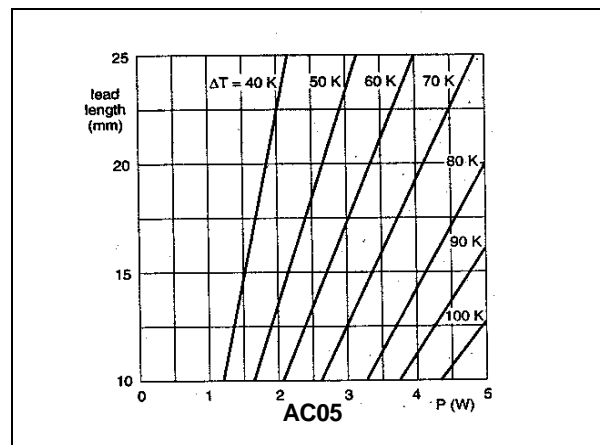
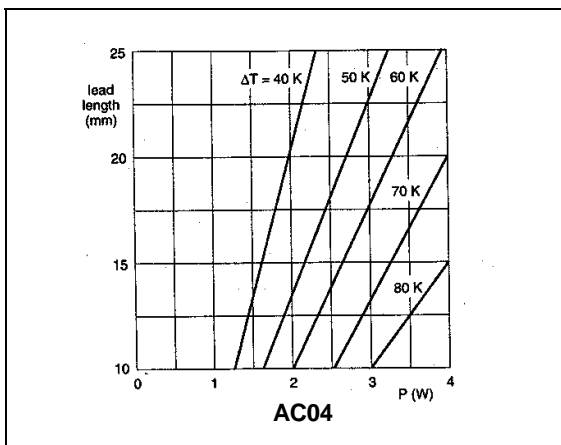
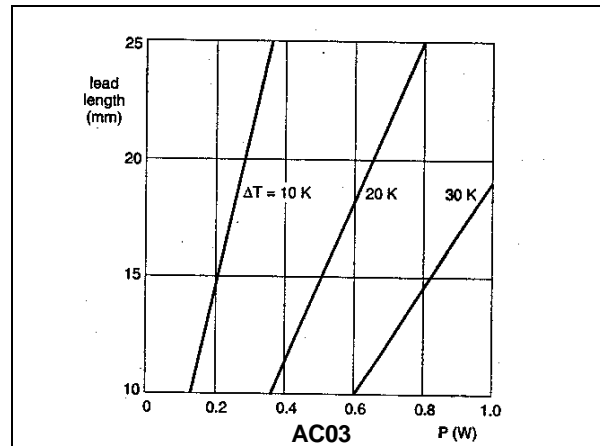
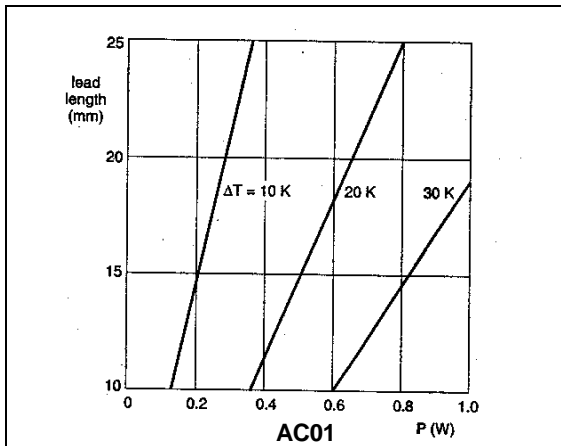

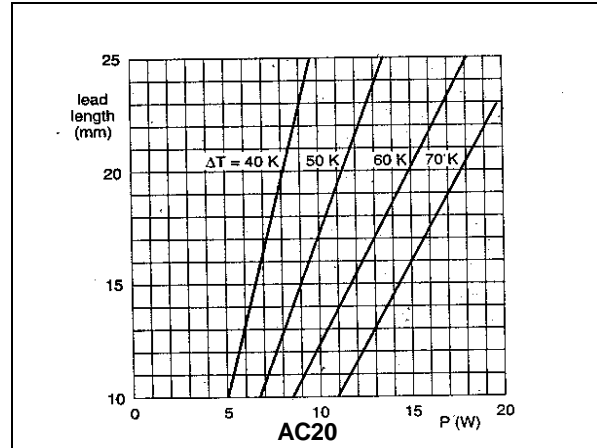
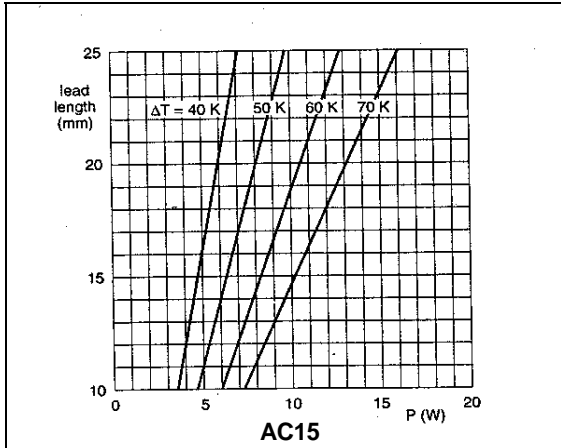

PULSE LOAD CAPABILITIES

How to interpret the maximum allowed pulse load from the graphs see details and definitions on general introduction

AC 01 – Single Pulse

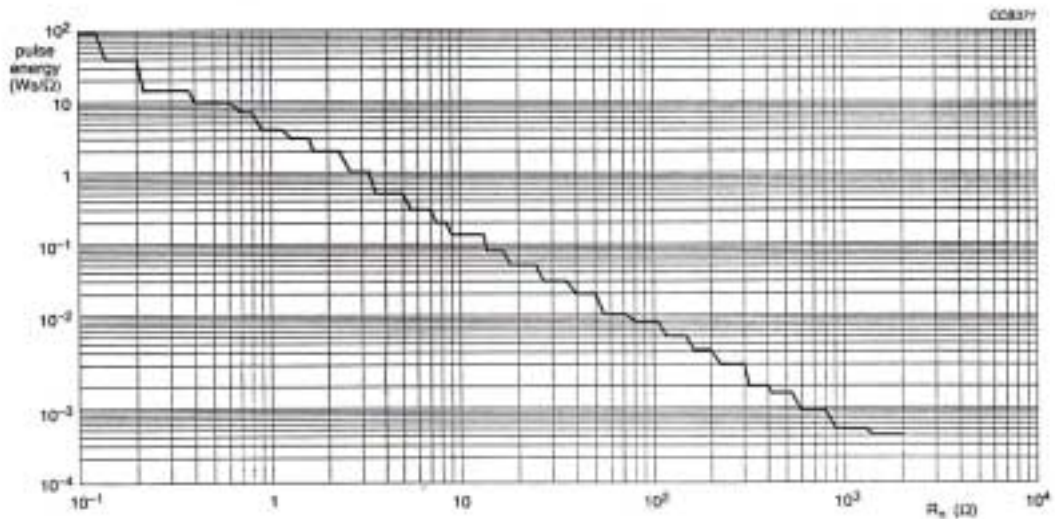

AC 01 – Repetitive Pulse

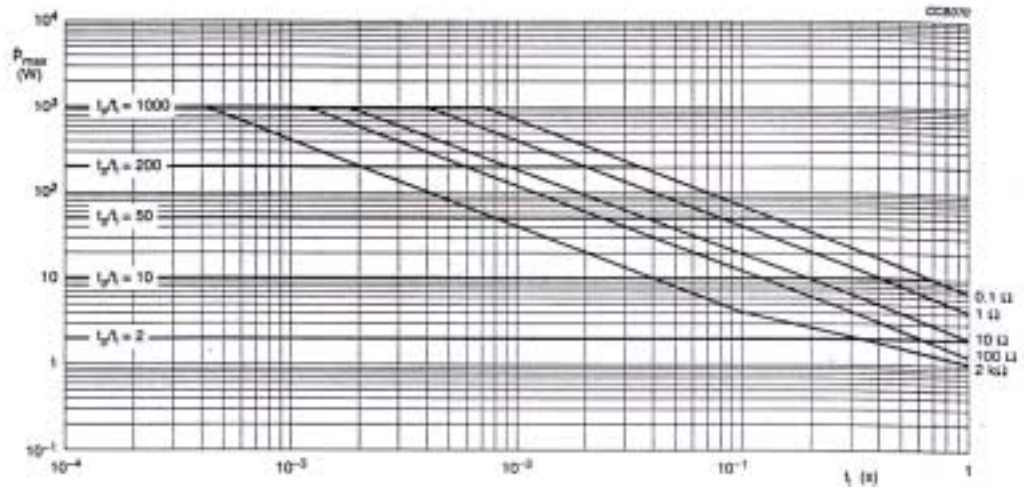

Pulse on regular basis; maximum permissible peak pulse power (Pmax) as a function of pulse duration (ti)

AC 01

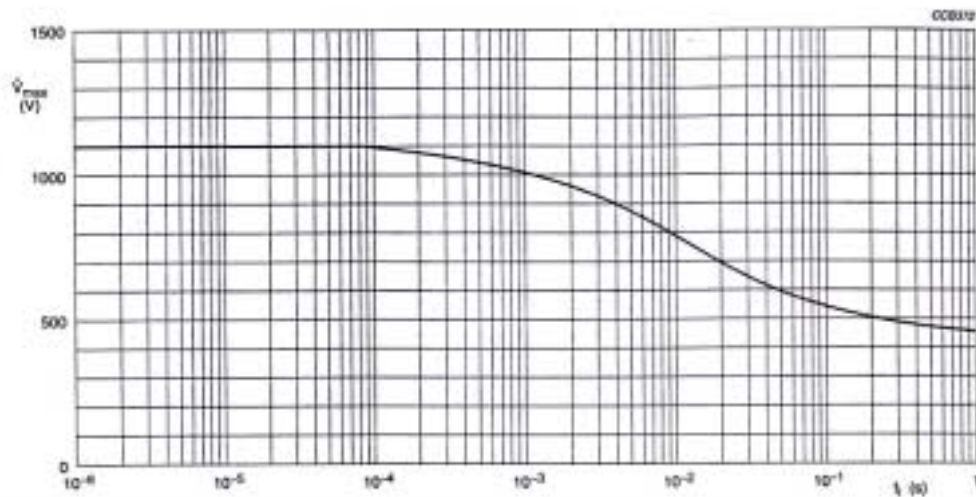

Pulse on regular basis; maximum permissible peak pulse voltage (Vmax) as a function of pulse duration (ti)

AC 03 – Single Pulse

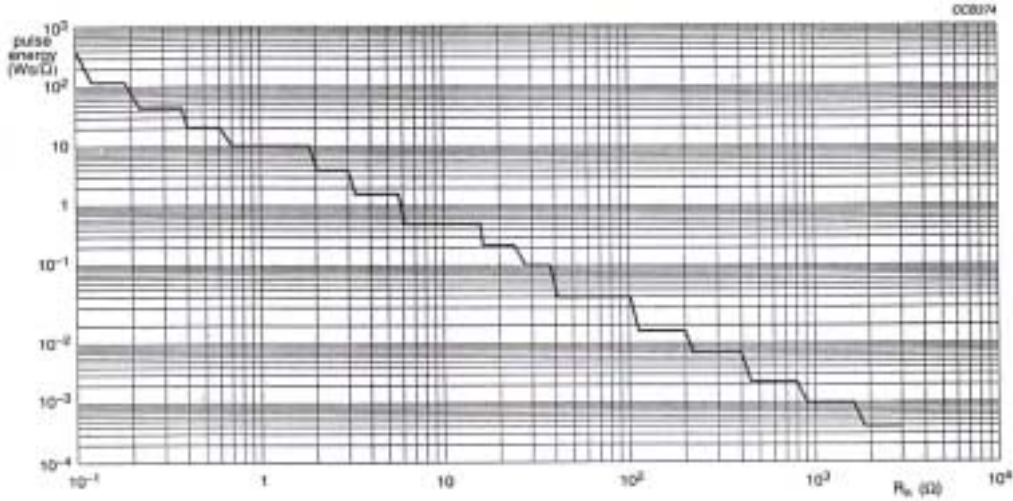

Pulse capability; W_s as a function of R_n .

AC 03 – Repetitive Pulse

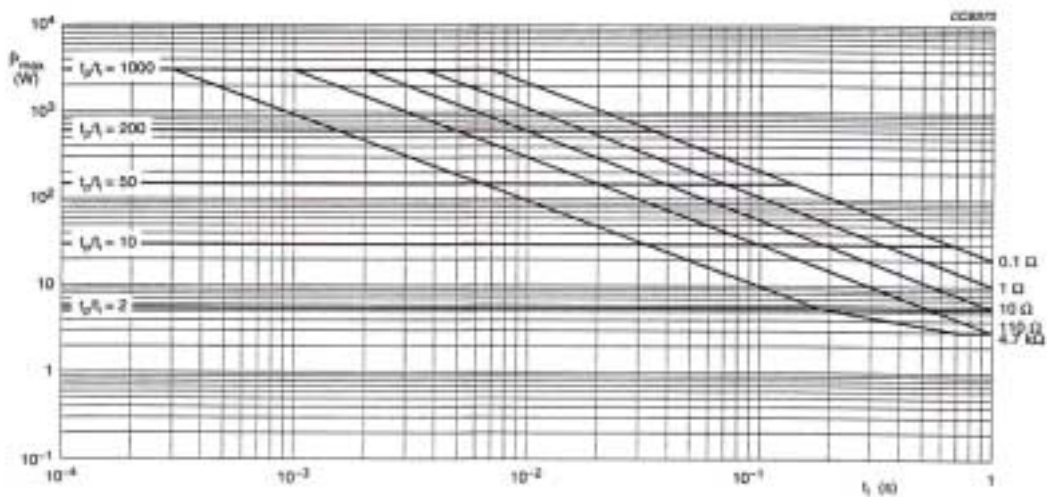

Pulse on regular basis; maximum permissible peak pulse power (P_{max}) as a function of pulse duration (t_i)

AC 03

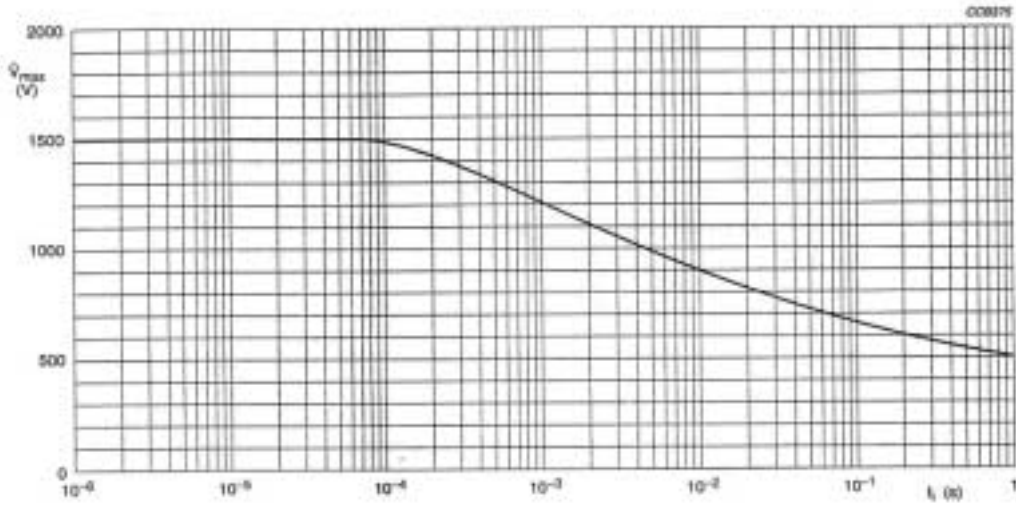

Pulse on regular basis; maximum permissible peak pulse voltage (V_{max}) as a function of pulse duration (t_i)

AC 04 – Single Pulse

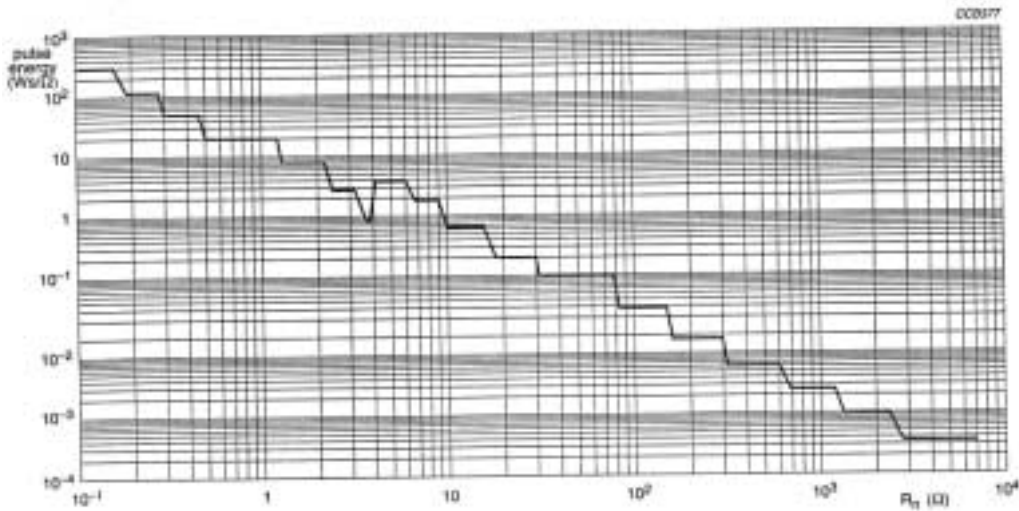

Pulse capability; W_s as a function of R_n .

AC 04 – Repetitive Pulse

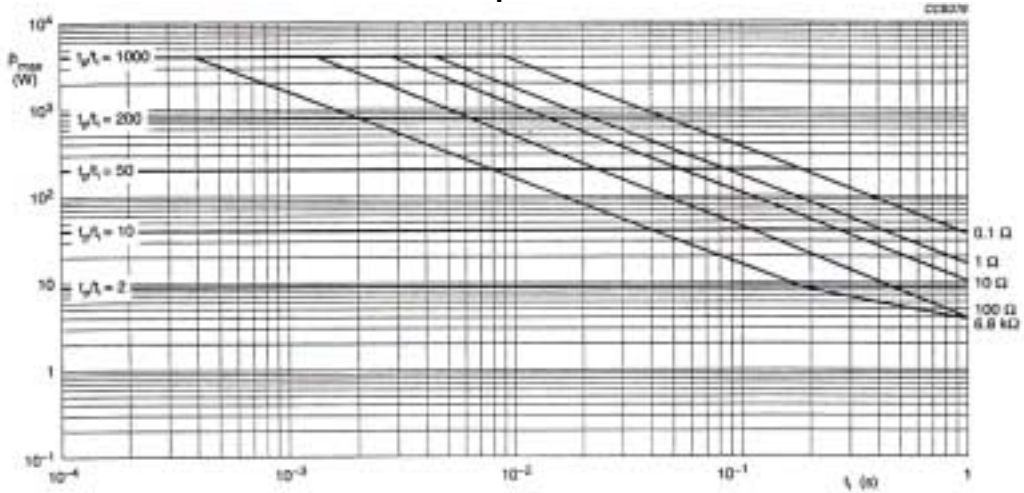

Pulse on regular basis; maximum permissible peak pulse power (P_{max}) as a function of pulse duration (t_i)

AC 04

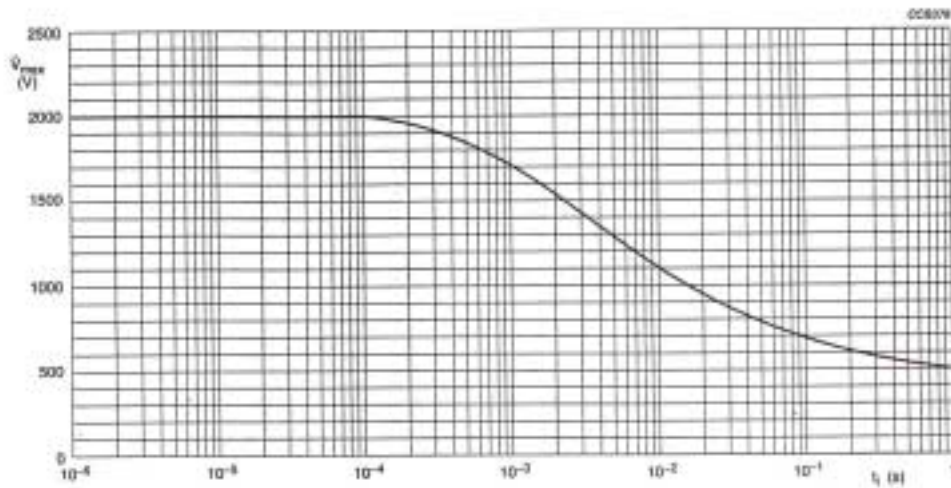

Pulse on regular basis; maximum permissible peak pulse voltage (V_{max}) as a function of pulse duration.

AC 05 – Repetitive Pulse

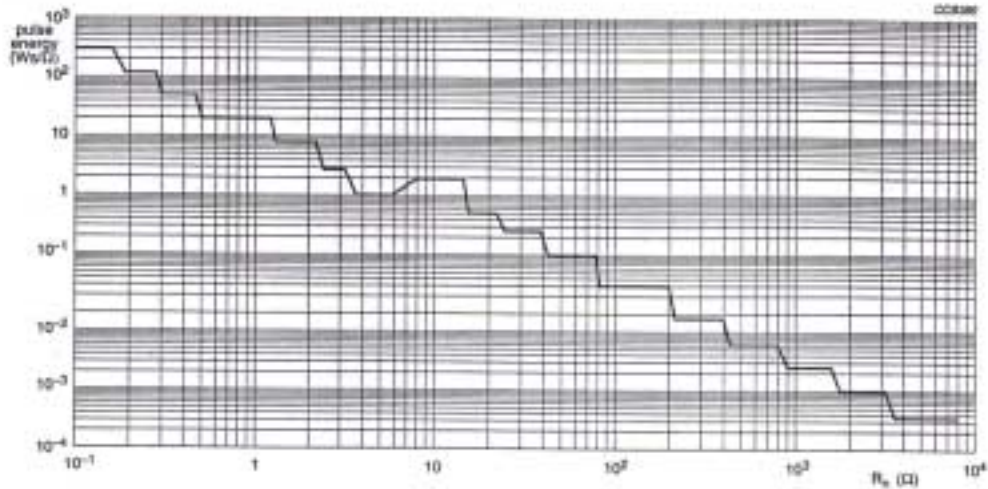

Pulse capability; W_s as a function of R_n .

AC 05 – Repetitive Pulse

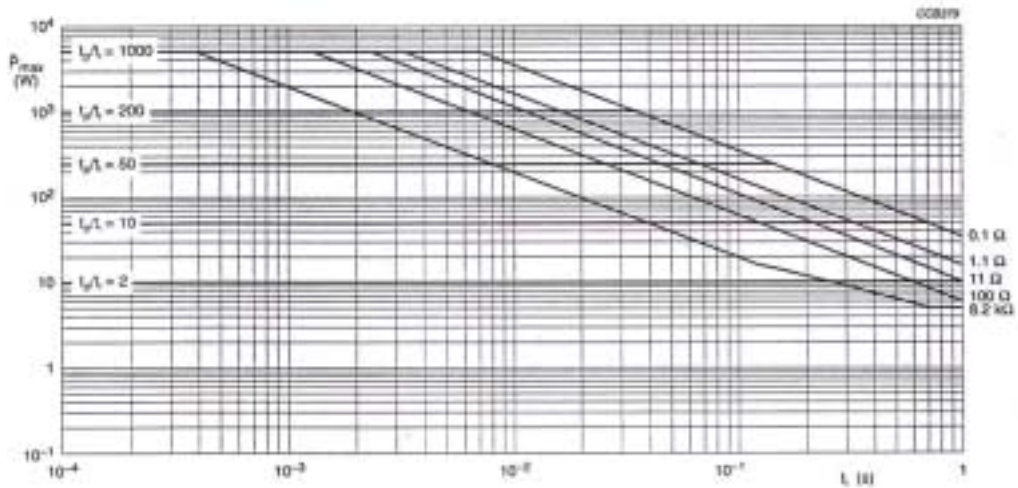

Pulse on regular basis; maximum permissible peak pulse power (P_{max}) as a function of pulse duration (t_i)

AC 05

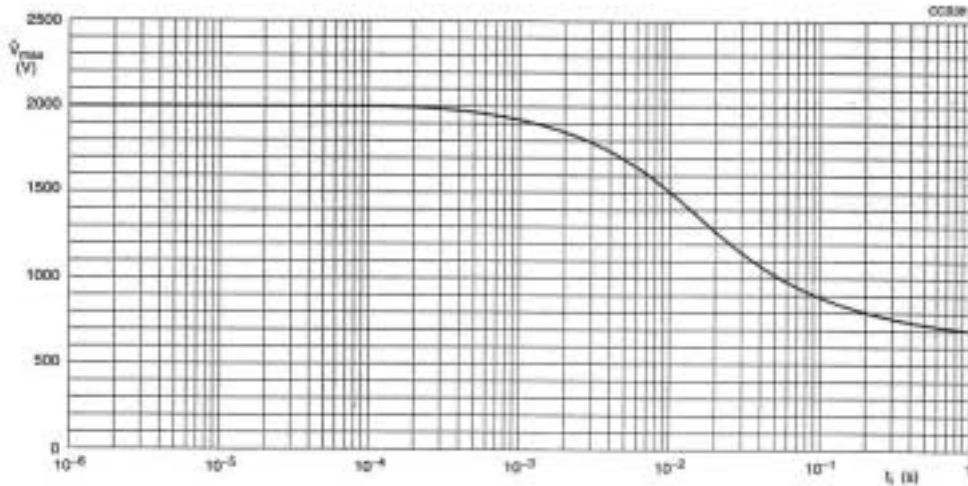

Pulse on regular basis; maximum permissible peak pulse voltage (V_{max}) as a function of pulse duration (t_i)

AC 07 – Single Pulse

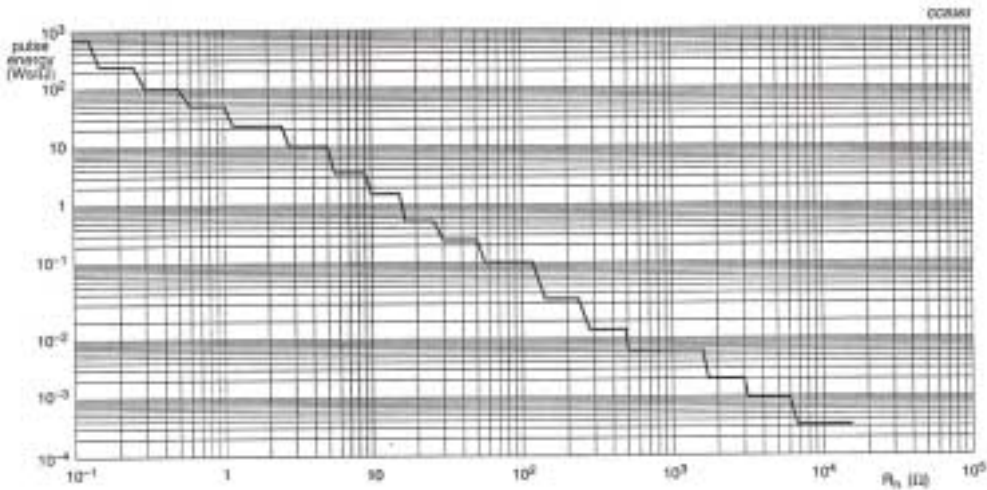

Pulse capability; W_s as a function of R_n .

AC 07 – Repetitive Pulse

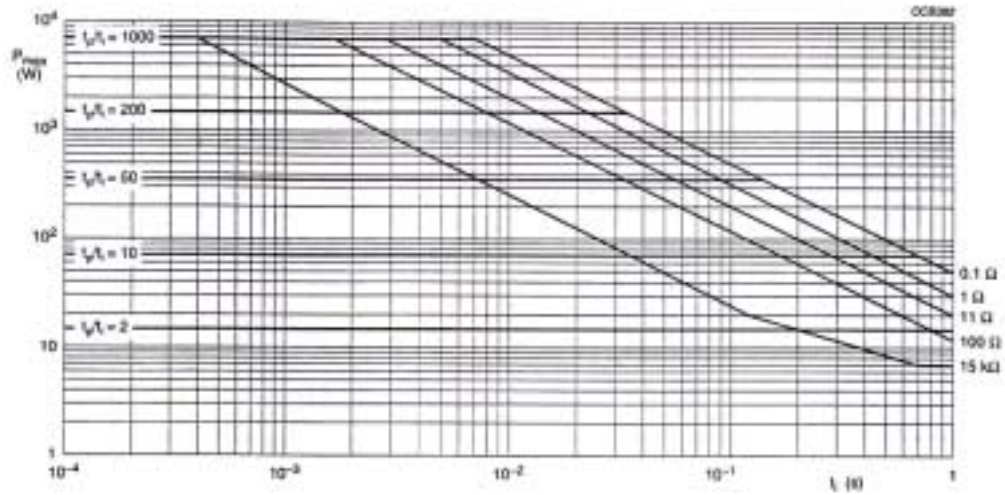

Pulse on regular basis; maximum permissible peak pulse power (Pmax) as a function of pulse duration (ti)

AC 07

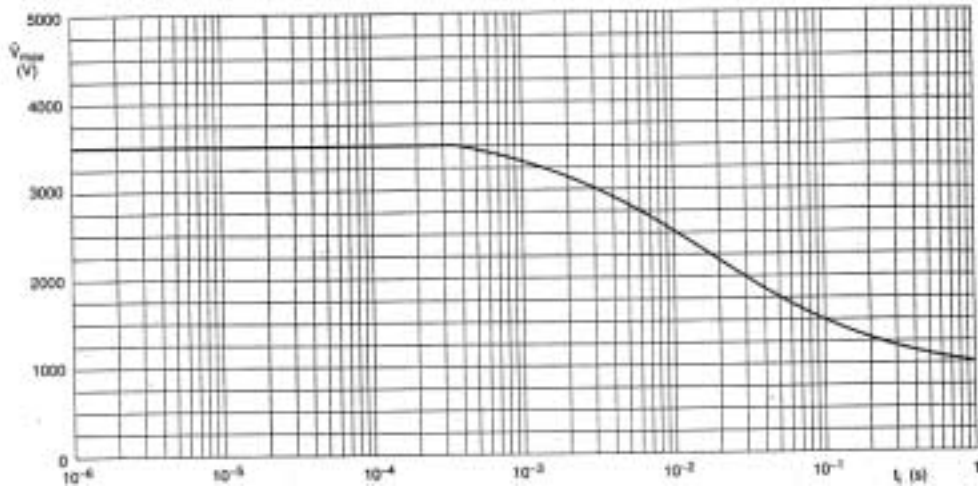

Pulse on regular basis; maximum permissible peak pulse voltage (Vmax) as a function of pulse duration (ti)

AC 10 – Repetitive Pulse

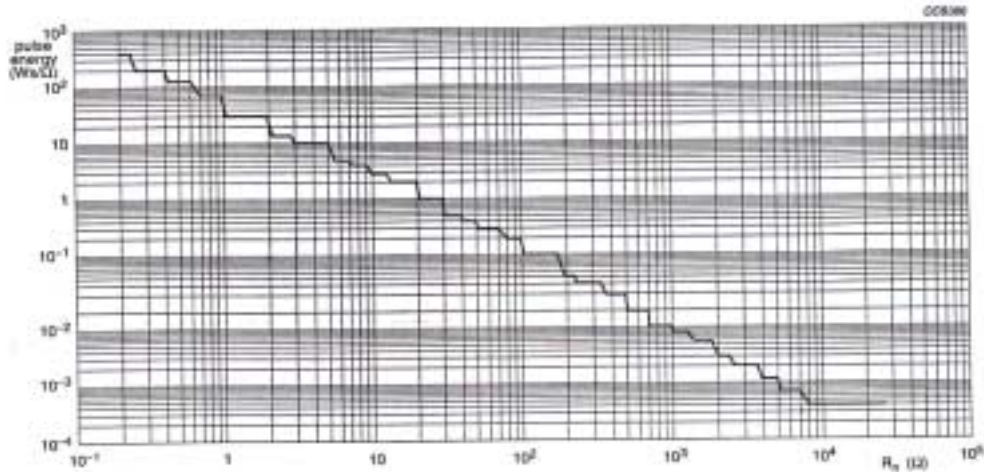

Pulse capability; W_s as a function of R_n .

AC 10 – Repetitive Pulse

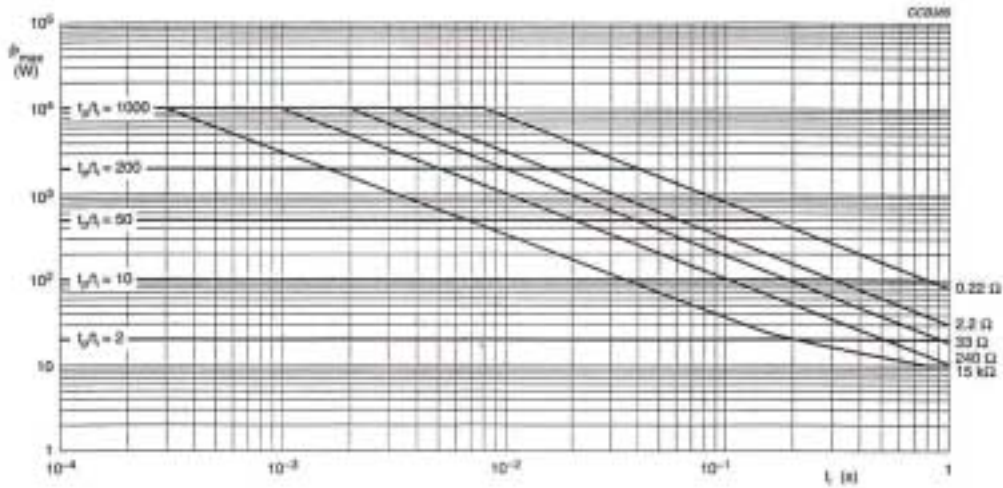

Pulse on regular basis; maximum permissible peak pulse power (P_{max}) as a function of pulse duration (t_i)

AC 10

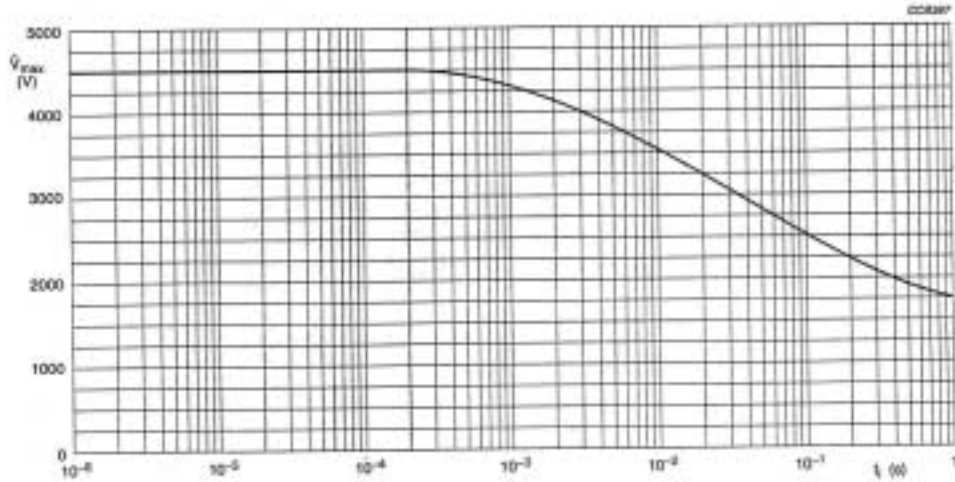

Pulse on regular basis; maximum permissible peak pulse voltage (V_{max}) as a function of pulse duration (t_i)

AC 15 – Single Pulse

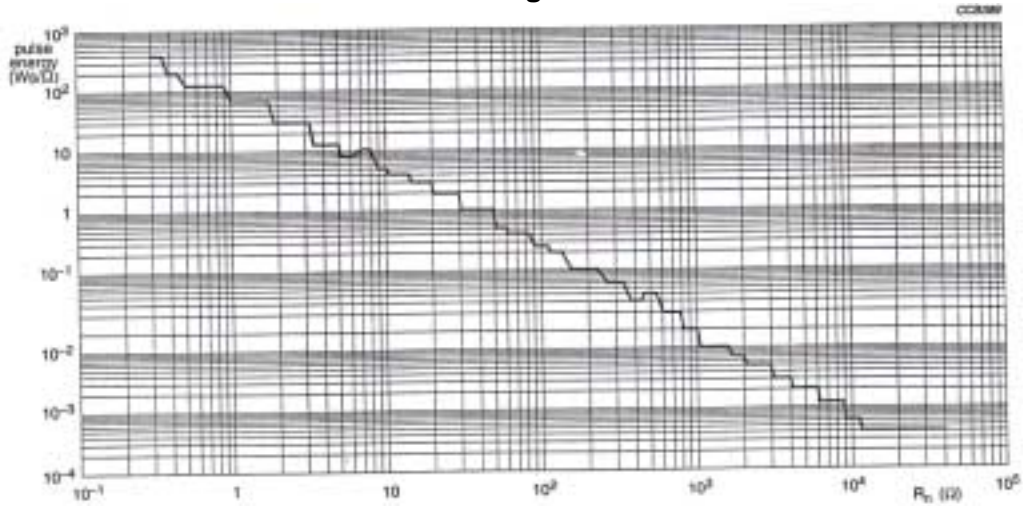

Pulse capability; W_s as a function of R_n .

AC 15 – Repetitive Pulse

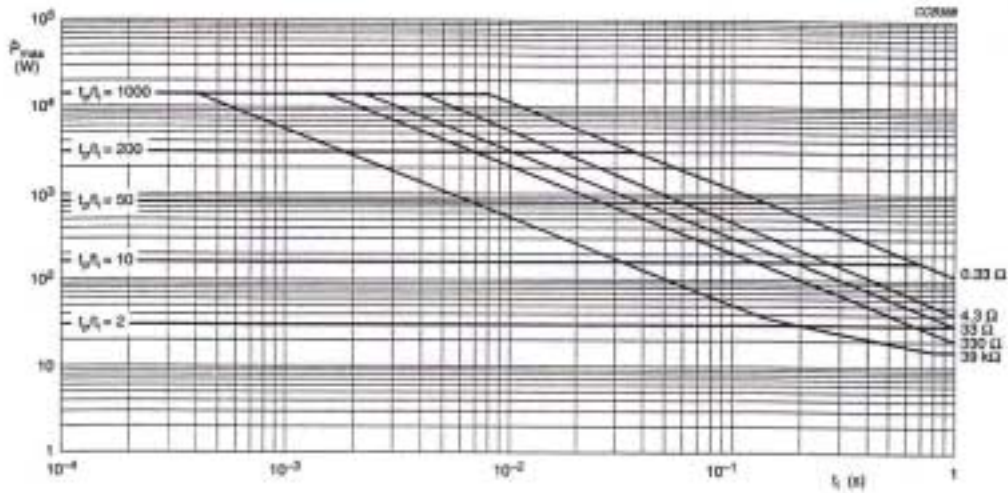

Pulse on regular basis; maximum permissible peak pulse power (Pmax) as a function of pulse duration (ti)

AC 15

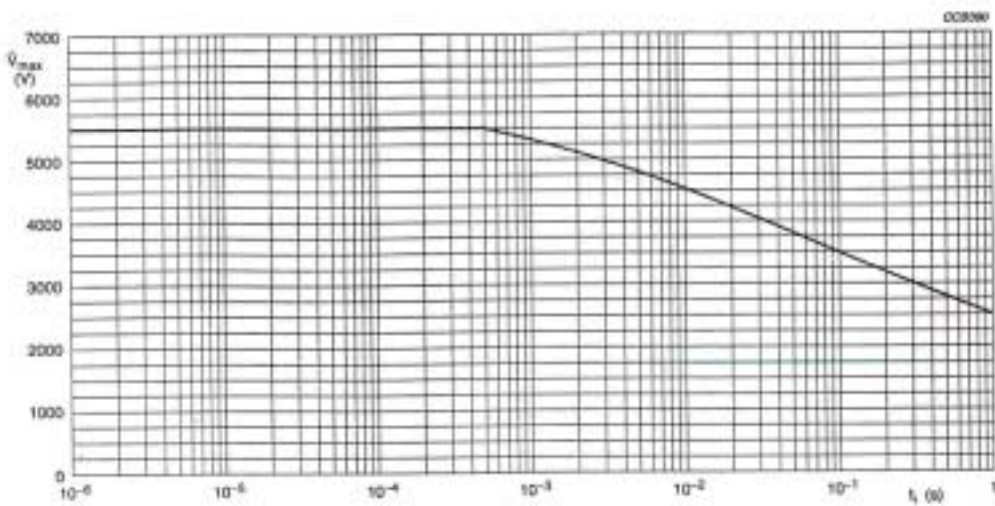

Pulse on regular basis; maximum permissible peak pulse voltage (Vmax) as a function of pulse duration (ti)

AC 20 – Single Pulse

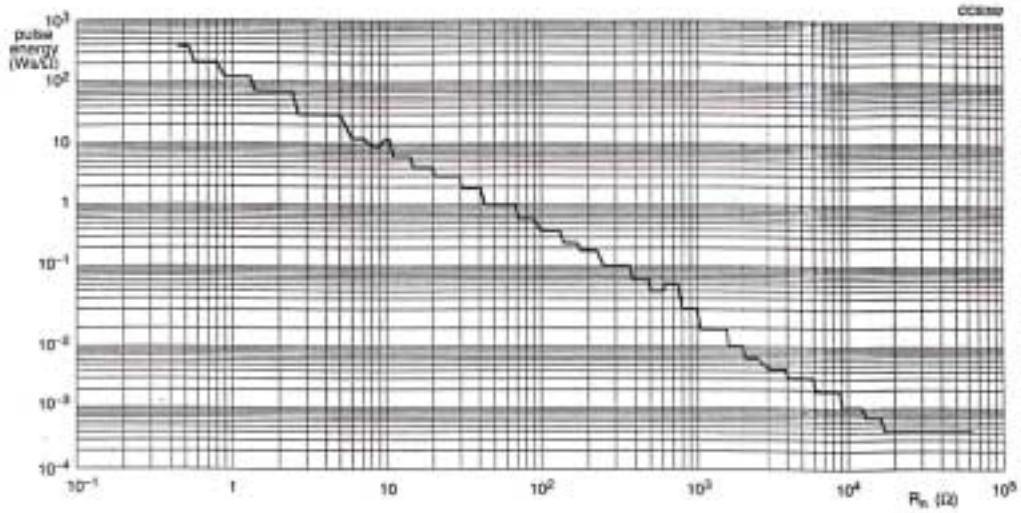

Pulse capability; W_s as a function of R_n .

AC 20 – Repetitive Pulse

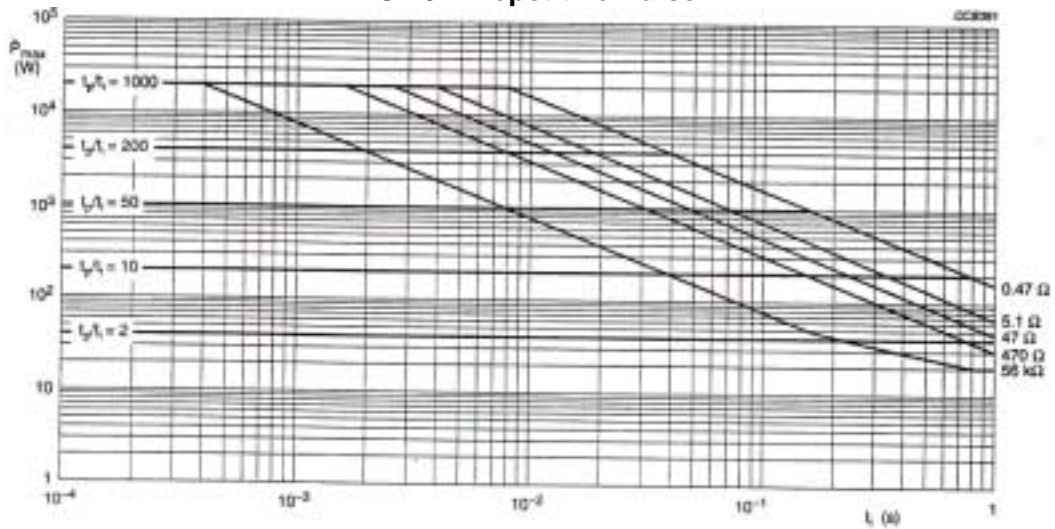

Pulse on regular basis; maximum permissible peak pulse power (P_{max}) as a function of pulse duration (t_i)

AC 20

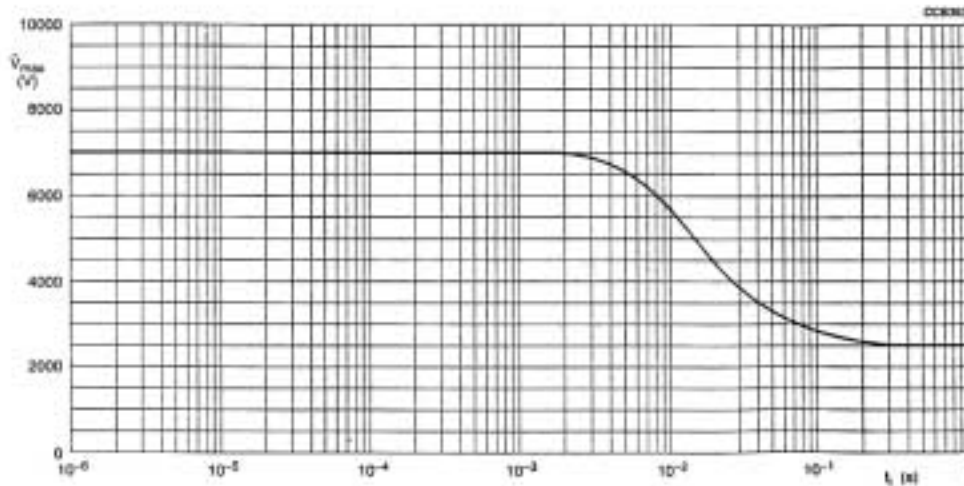

Pulse on regular basis; maximum permissible peak pulse voltage (V_{max}) as a function of pulse duration (t_i)

MARKING

The resistor is marked with the nominal resistance value, the tolerance on the resistance and the rated dissipation at $T_{amb} = 40^\circ\text{C}$.

For values up to 910Ω , the R is used as the decimal point.

For values of $1\text{K}\Omega$ and upwards, the letter K is used as the decimal point for the $\text{K}\Omega$ indication.

Example:

6K8 5% 5W

ORDERING CODE (12NC)

The resistors have a 12-digit ordering code indicating the resistor type and resistive value.

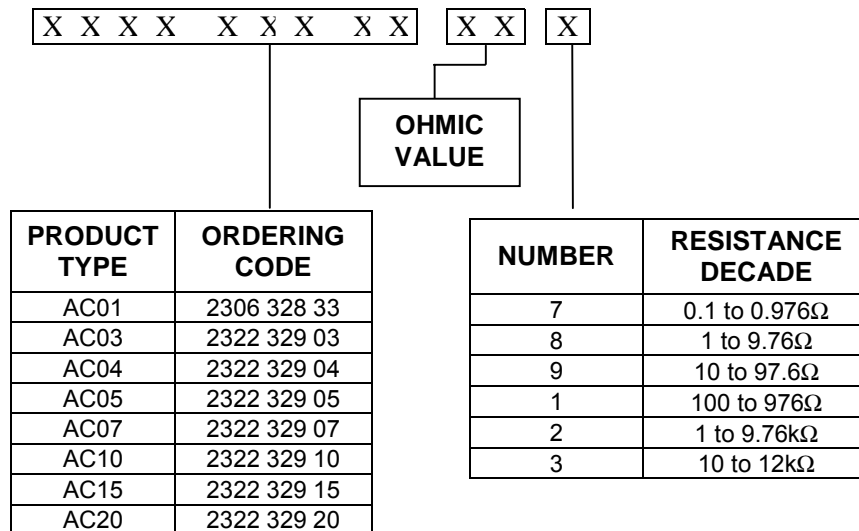

Ordering example:

The ordering code of the AC01 resistor, value 47Ω 5%, supplied in ammpack of 1000 units is:
2306 328 33479

NAFTA ORDERING INFORMATION - CROSS REFERENCE

NAFTA ORDERING CODES

The resistor have on ordering code with 12 digits, first 5 digits for product type and the subsequent digits indicate the resistance value and tolerance.

Type	Resistance range	Tol. %	12NC	Nafta part Number ⁽¹⁾	SPQ units
AC01	0.1 Ω to 2 KΩ	± 5	2306 328 33xxx	AC01WxxxxxJ	1000; ammpack
AC02	0.1 Ω to 4,7 KΩ	± 5	2306 326 33xxx	AC02WxxxxxJ	500; ammpack
AC03	0.1 Ω to 4.7 KΩ	± 5	2322 329 03xxx	AC03WxxxxxJ	500; ammpack
AC03	0.1 Ω to 5.1 KΩ	± 5	2306 326 45xxx	AC03WxxxxxJCF203	500; Box
AC04	0.1 Ω to 6.8 KΩ	± 5	2322 329 04xxx	AC04WxxxxxJ	500; ammpack
AC05	0.1 Ω to 8.2 KΩ	± 5	2322 329 05xxx	AC05WxxxxxJ	500; ammpack
AC05	0.1 Ω to 10 KΩ	± 5	2306 321 45xxx	AC05WxxxxxJCF203	500; Box
AC07	0.1 Ω to 15 KΩ	± 5	2322 329 07xxx	AC07WxxxxxJ	500; ammpack
AC10	0.68 Ω to 27 KΩ	± 5	2322 329 10xxx	AC10WxxxxxJ	500; ammpack
AC15	0.82 Ω to 39 KΩ	± 5	2322 329 15xxx	AC15WxxxxxJ	100; Box
AC20	1.2 Ω to 56 KΩ	± 5	2322 329 20xxx	AC20WxxxxxJ	100; Box

COMPOSITION OF OHMIC VALUE

The ohmic value is represented by 5 digits.

Value	5 Digits (All Other)
1 Ω	1R000
10 Ω	10R00
100 Ω	100R0
1 K Ω	1K000
10 K Ω	10K00
100 K Ω	100K0
1 M Ω	1M000

Ordering example:

The ordering code for AC01, value 47 Ω 5% , supplied in ammpack of 1000 units is: AC01W47R00J

PACKAGING

Axial resistor (taped or loose in box)

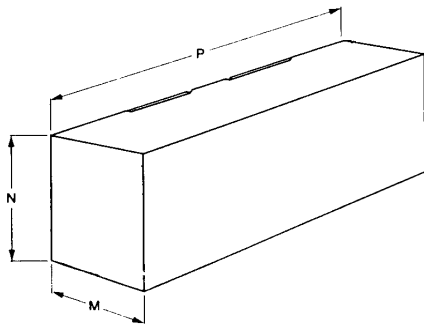

TYPE	QUANTITY	M	N	P
AC01 Tape in box	1000	85 (3.346)	60 (2.362)	263 (10.354)
AC03 Tape in box	500	85 (3.346)	77 (3.031)	259 (10.197)
AC04 Tape in box	500	85 (3.346)	77 (3.031)	259 (10.197)
AC05 Tape in box	500	85 (3.346)	112 (4.409)	259 (10.197)
AC07 Tape in box	500	93 (3.661)	115 (4.527)	259 (10.197)
AC10 Tape in box	500	110 (4.331)	117 (4.606)	275 (10.827)
AC15 Loose in box	100	140 (5.512)	60 (2.362)	335 (13.189)
AC20 Loose in box	100	140 (5.512)	60 (2.362)	335 (13.189)

Dimensions in mm (inches)

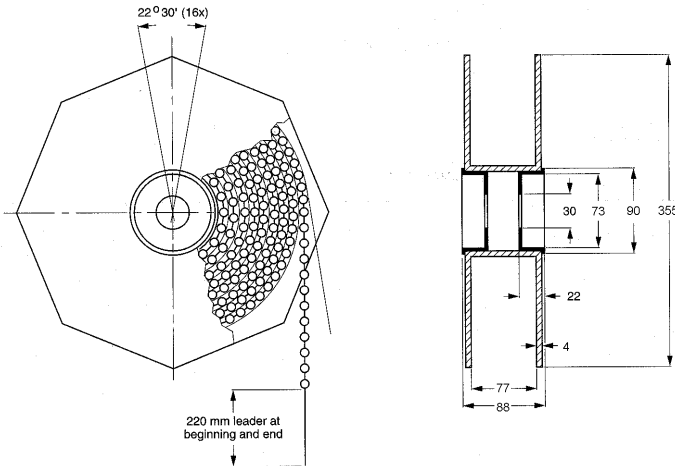
Axial resistor taped in reel (Special part number under request)

Dimensions in mm.

TYPE	QUANTITY
AC01	4000
AC02	1500
AC03	1500
AC04	1500
AC05	1000

TESTS AND REQUIREMENTS

Essentially all tests and requirements present in table below, follow the schedule of IEC standard, publication 60115-1, 60115-4 and 60068.

IEC 60115-1 CLAUSE	IEC 60068 TEST METHOD	TEST	PROCEDURE	REQUIREMENTS
4.8.4.2		Temperature coefficient	At 20/-40/20°C. 20/200/20°C: Resistive value < 10Ω Resistive value ≥ 10Ω	TC ≤ ±600ppm/°C - 80 ppm / °C ≤ TC TC ≤ +140 ppm / °C
	Temperature rise	Horizontally mounted. loaded with Pn		Hot spot temperature less than maximum body temperature.
4.13		Short time overload	Room temperature; dissipation 10 x Pn; 5s (voltage not more than 1000V / 25mm)	ΔR/Rmax.: ± 2% + 0.1Ω
4.15		Robustness of resistor body.	load 200 ± 10N	no visible damage ΔR/Rmax.: 0.5% + 0.05Ω

AC

