

# Photologic® Slotted Optical Switch

## OPB930 and OPB940 (L and W Series)



### Features:

- Choice of aperture size
- Choice of output configurations
- Choice of opaque or IR transmissive shell
- Choice of pins (L) or wires (W)
- 0.125" (3.18 mm) slot width
- 0.320" (8.128 mm) lead spacing for PCBoard (side mounting)
- Data rates to 250 kBaud

### Description:

The **OPB930** and **OPB940** series of Photologic® photo integrated circuit switches provide optimum flexibility for the design engineer. Building from a standard housing with a 0.125" (3.18 mm) wide slot, a user can specify the type and polarity of TTL output, discrete shell material, aperture width and either 0.350" (8.9 mm) long pins (**L Series**) or 24" (610 mm) AWG, UL listed wire leads (**W Series**).

All housings are made from an opaque grade of injection-molded plastic that minimizes the assembly's sensitivity to both visible and near-infrared ambient radiation. Discrete shells (exposed on the parallel faces inside the device throat) are either IR transmissive plastic (for applications where aperture contamination may occur) or opaque plastic (for maximum protection against ambient light).

Electrical output can be specified as either TTL Totem Pole or TTL Open Collector, either of which can be supplied with buffer or inverter output polarity. All devices have the added stability of a built-in hysteresis amplifier.

Custom electrical, wire and cabling and connectors are available. Contact your local representative or OPTEK for more information.

### Applications:

- Mechanical switch replacement
- Speed indication (tachometer)
- Mechanical limit indication
- Edge sensing

### Part Number Guide — OPB930 and OPB940 Series



**CONTAINS POLYSULFONE**

To avoid stress cracking, we suggest using ND Industries' **Vibra-Tite** for thread-locking. **Vibra-Tite** evaporates fast without causing structural failure in OPTEK's molded plastics.



General Note  
TT Electronics reserves the right to make changes in product specification without notice or liability. All information is subject to TT Electronics' own data and is considered accurate at time of going to print.

OPTEK Technology, Inc.  
1645 Wallace Drive, Carrollton, TX 75006 | Ph: +1 972 323 2200  
www.optekinc.com | www.ttelectronics.com

# Photologic® Slotted Optical Switch

## OPB930 and OPB940 (L and W Series)



**OPB930, OPB940 Buffered Totem-Pole**



**OPB931, OPB941 Buffered Open-Collector**



**OPB932, OPB942 Inverted Totem-Pole**



**OPB933 & OPB943 Inverted Open-Collector**



**Absolute Maximum Ratings ( $T_A = 25^\circ\text{C}$  unless otherwise noted)**

Supply Voltage, $V_{CC}$ (not to exceed 3 seconds)	10 V
Operating Temperature Range	$-40^\circ\text{C}$ to $+70^\circ\text{C}$
Storage Temperature Range	$-40^\circ\text{C}$ to $+85^\circ\text{C}$
Lead Soldering Temperature (1/16 inch (1.6mm) from the case for 5 sec. with soldering iron <sup>(1)</sup> )	$260^\circ\text{C}$
<b>Input Infrared LED</b>	
Input Diode Power Dissipation <sup>(2)</sup>	100 mW
Output Photologic® Power Dissipation <sup>(3)</sup>	200 mW
Total Device Power Dissipation <sup>(4)</sup>	300 mW
<b>Output Photologic®</b>	
Voltage at Output Lead (Open Collector Output)	35 V
Diode Forward DC Current	40 mA
Diode Reverse DC Voltage	2 V

**Notes:**

- (1) RMA flux is recommended. Duration can be extended to 10 seconds maximum when flow soldering.
- (2) Derate linearly 2.22 mW/ $^\circ\text{C}$  above  $25^\circ$ .
- (3) Derate linearly 4.44 mW/ $^\circ\text{C}$  above  $25^\circ$ .
- (4) Derate linearly 6.66 mW/ $^\circ\text{C}$  above  $25^\circ$ .
- (5) OPB930L/OPB940L series devices are terminated with 0.020" square leads designed for PCBoard mounting.
- (6) Methanol and isopropanol are recommended as cleaning agents. Plastic housing is soluble in chlorinated hydrocarbons and ketones.
- (7) All parameters tested using pulse technique.

General Note  
TT Electronics reserves the right to make changes in product specification without notice or liability. All information is subject to TT Electronics' own data and is considered accurate at time of going to print.

OPTEK Technology, Inc.  
1645 Wallace Drive, Carrollton, TX 75006 | Ph: +1 972 323 2200  
www.optekinc.com | www.ttelectronics.com

# Photologic® Slotted Optical Switch

## OPB930 and OPB940 (L and W Series)

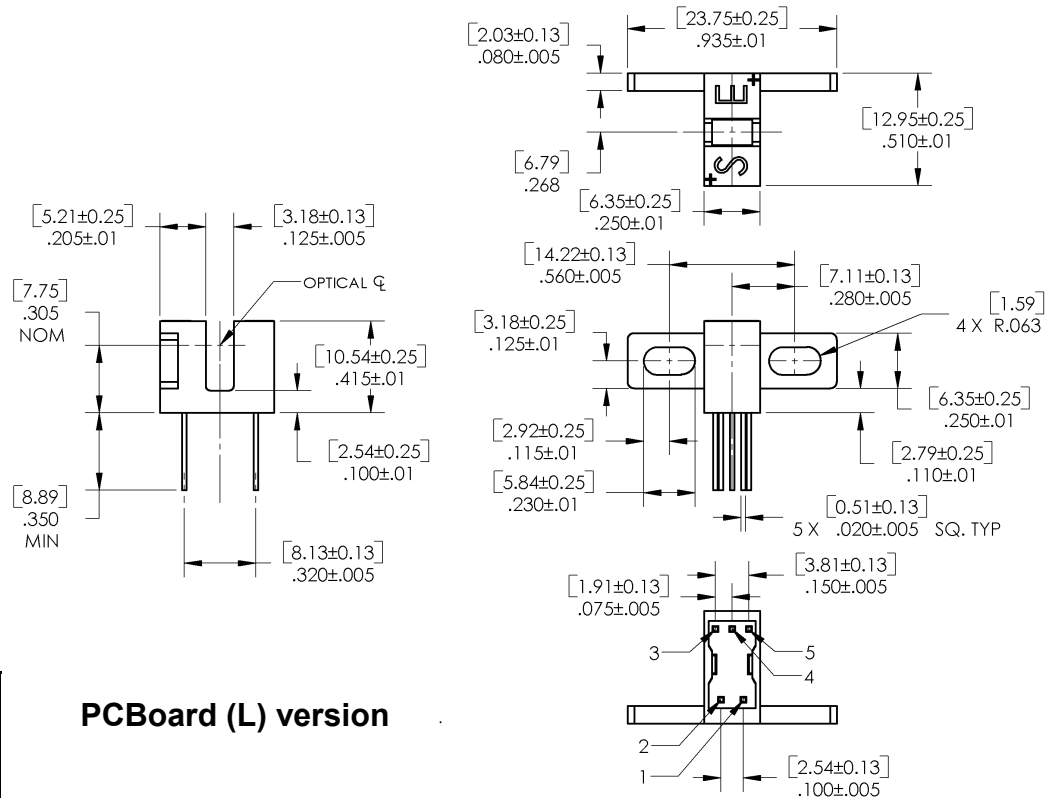

**PCBoard (L) version**

Color- Pin #	Description
Red—1	Anode
Black—2	Cathode
White—3	V <sub>CC</sub>
Blue—4	Output
Green—5	Ground

DIMENSIONS ARE IN: [ MILLIMETERS ]  
[ INCHES ]

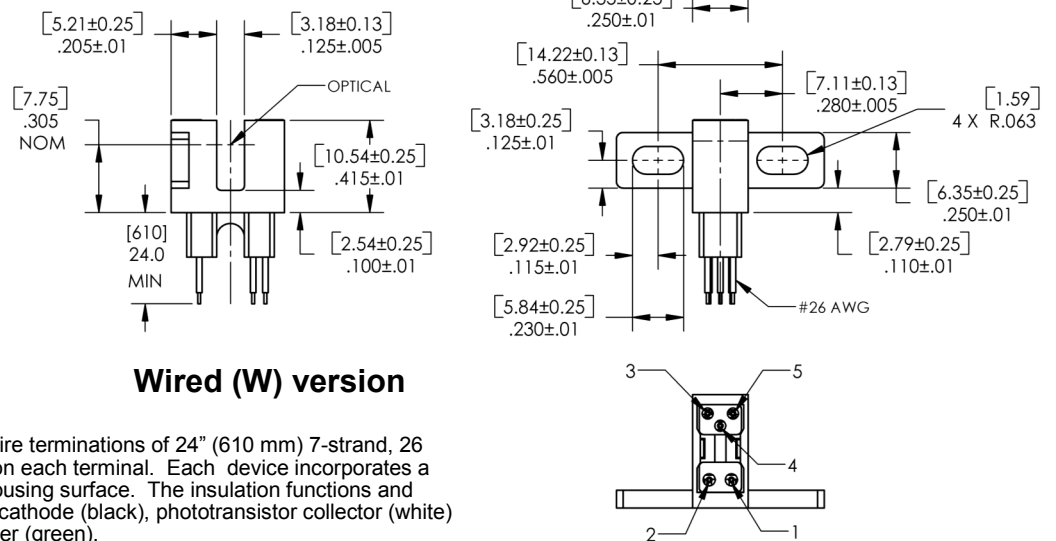

**Wired (W) version**

The W Series includes wire terminations of 24" (610 mm) 7-strand, 26 AWG UL insulated wire on each terminal. Each device incorporates a wire strain relief at the housing surface. The insulation functions and colors are: anode (red), cathode (black), phototransistor collector (white) and phototransistor emitter (green).

General Note  
TT Electronics reserves the right to make changes in product specification without notice or liability. All information is subject to TT Electronics' own data and is considered accurate at time of going to print.

OPTEK Technology, Inc.  
1645 Wallace Drive, Carrollton, TX 75006 | Ph: +1 972 323 2200  
www.optekinc.com | www.ttelectronics.com

# Photologic® Slotted Optical Switch

## OPB930 and OPB940 (L and W Series)



Electrical Characteristics (T <sub>A</sub> = 25° C unless otherwise noted)						
SYMBOL	PARAMETER	MIN	TYP	MAX	UNITS	TEST CONDITIONS
<b>Input Diode</b>						
V <sub>F</sub>	Forward Voltage	-	-	1.7	V	I <sub>F</sub> = 20 mA
I <sub>R</sub>	Reverse Current	-	-	100	μA	V <sub>R</sub> = 2.0 V
<b>Output Photologic® Sensor</b>						
V <sub>CC</sub>	Operating D.C. Supply Voltage	4.75	-	5.25	V	-
I <sub>CCL</sub>	Low Level Supply Current: Totem Pole & Open-Collector	-	-	15	mA	V <sub>CC</sub> = 5.25, I <sub>F</sub> = 0 mA <sup>(1)</sup>
	Inverted Totem-Pole & Inverted Open-Collector	-	-	15	mA	V <sub>CC</sub> = 5.25, I <sub>F</sub> = 15 mA
I <sub>CCH</sub>	High Level Supply Current: Totem Pole & Open-Collector	-	-	15	mA	V <sub>CC</sub> = 5.25, I <sub>F</sub> = 15 mA
	Inverted Totem-Pole & Inverted Open-Collector	-	-	15	mA	V <sub>CC</sub> = 5.25, I <sub>F</sub> = 0 mA <sup>(1)</sup>
V <sub>OL</sub>	Low Level Output Voltage: Totem Pole & Open-Collector	-	-	0.4	V	V <sub>CC</sub> = 4.75, I <sub>OL</sub> = 12.8 mA, I <sub>F</sub> = 0 mA <sup>(1)</sup>
	Inverted Totem-Pole & Inverted Open-Collector	-	-	0.4	V	V <sub>CC</sub> = 4.75, I <sub>OL</sub> = 12.8 mA, I <sub>F</sub> = 15 mA
V <sub>OH</sub>	High Level Output Voltage: Totem-Pole & Open-Collector	2.4	-	-	V	V <sub>CC</sub> = 4.75, I <sub>OH</sub> = -800 μA, I <sub>F</sub> = 15 mA
	Inverted Totem-Pole & Inverted Open-Collector	2.4	-	-	V	V <sub>CC</sub> = 4.75, I <sub>OH</sub> = -800 μA, I <sub>F</sub> = 0 mA
I <sub>OH</sub>	High Level Output Current: Totem Pole & Open-Collector	-	-	100	μA	V <sub>CC</sub> = 4.75, V <sub>OH</sub> = 30 V, I <sub>F</sub> = 15 mA,
	Inverted Totem-Pole & Inverted Open-Collector	-	-	100	μA	V <sub>CC</sub> = 4.75, V <sub>OH</sub> = 30 V, I <sub>F</sub> = 0 mA <sup>(1)</sup>
I <sub>F</sub> (+)	LED Positive-Going Threshold Current	-	-	15	mA	V <sub>CC</sub> = 5.0 V
I <sub>F</sub> (+), I <sub>F</sub> (-)	Hysteresis	-	2.0	-	V	V <sub>CC</sub> = 5.0 V
I <sub>OS</sub>	Short Circuit Output Current: Totem Pole & Open-Collector	-15	-	-60	mA	V <sub>CC</sub> = 5.25 V, I <sub>F</sub> = 15 mA, Output = GND
	Inverted Totem-Pole & Inverted Open-Collector	-15	-	-60	mA	V <sub>CC</sub> = 5.25 V, I <sub>F</sub> = 0 mA <sup>(1)</sup> , Output = GND

General Note  
TT Electronics reserves the right to make changes in product specification without notice or liability. All information is subject to TT Electronics' own data and is considered accurate at time of going to print.

OPTEK Technology, Inc.  
1645 Wallace Drive, Carrollton, TX 75006 | Ph: +1 972 323 2200  
www.optekinc.com | www.ttelectronics.com

# Photologic<sup>®</sup> Slotted Optical Switch

## OPB930 and OPB940 (L and W Series)



### Electrical Characteristics ( $T_A = 25^\circ\text{C}$ unless otherwise noted)

SYMBOL	PARAMETER	MIN	TYP	MAX	UNITS	TEST CONDITIONS
$t_r, t_f$	Output Rise Time, Output Fall Time	-	70	-	ns	$V_{CC} = 5\text{ V}$ , $I_F = 0$ or 15 mA
$T_{PLH}$	Propagation Delay Low-High	-	5.0	-	$\mu\text{s}$	$R_L = 8\text{ TTL loads (Totem Pole)}$
$T_{PHL}$	Propagation Delay High-Low	-	5.0	-	$\mu\text{s}$	$R_L = 360\ \Omega$ (Open-Collector)

#### Notes:

- (1) Normal application would be with light source blocked, simulated by  $I_F = 0$  mA.
- (2) All parameters are tested using pulse techniques.

# Photologic® Slotted Optical Switch



## OPB930 and OPB940 (L and W Series)

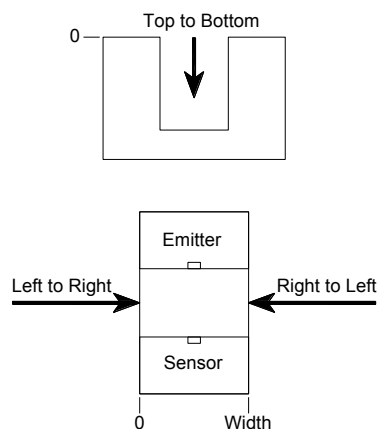
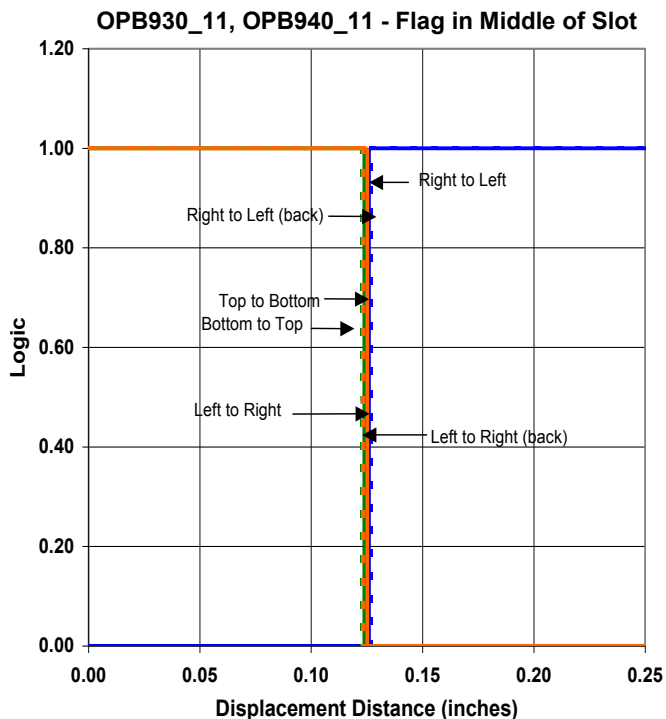
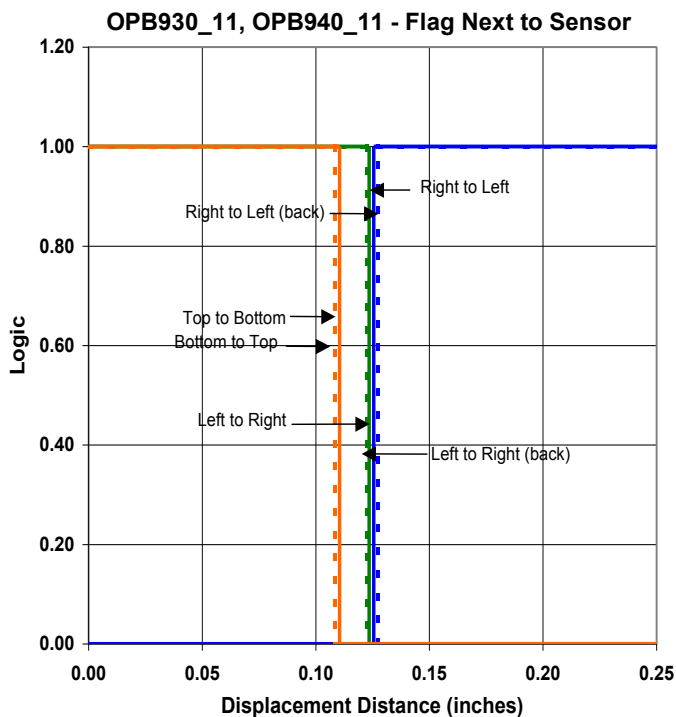
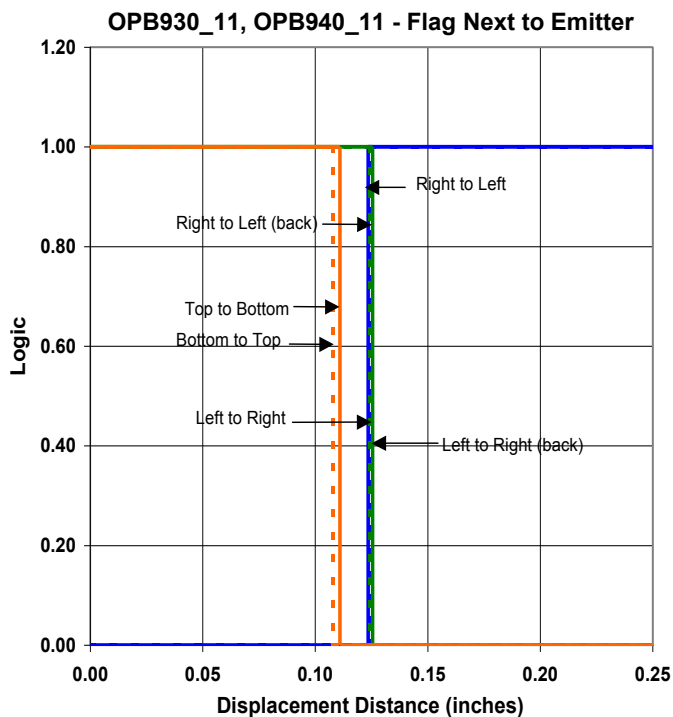

General Note  
TT Electronics reserves the right to make changes in product specification without notice or liability. All information is subject to TT Electronics' own data and is considered accurate at time of going to print.

OPTEK Technology, Inc.  
1645 Wallace Drive, Carrollton, TX 75006 | Ph: +1 972 323 2200  
www.optekinc.com | www.ttelectronics.com

# Photologic® Slotted Optical Switch



## OPB930 and OPB940 (L and W Series)

OPB930\_51, OPB940\_51 - Flag Next to Emitter

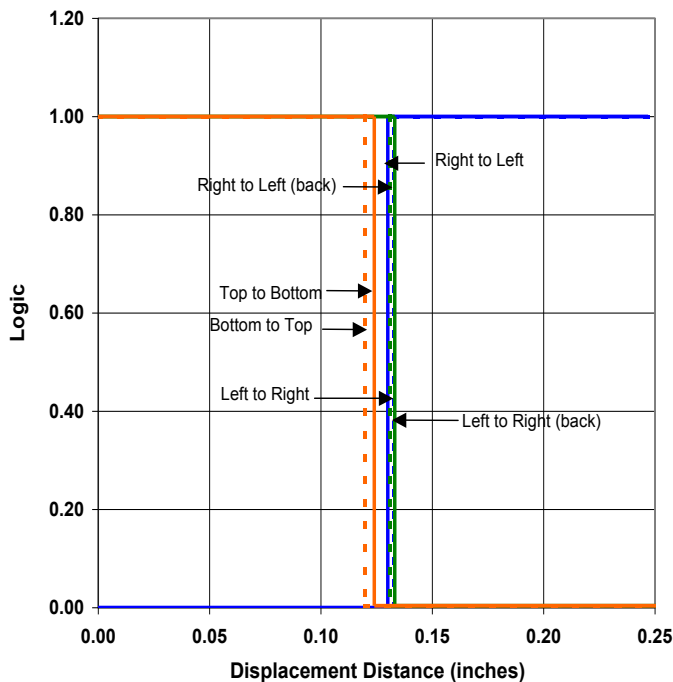

OPB930\_51, OPB940\_51 - Flag Next to Sensor

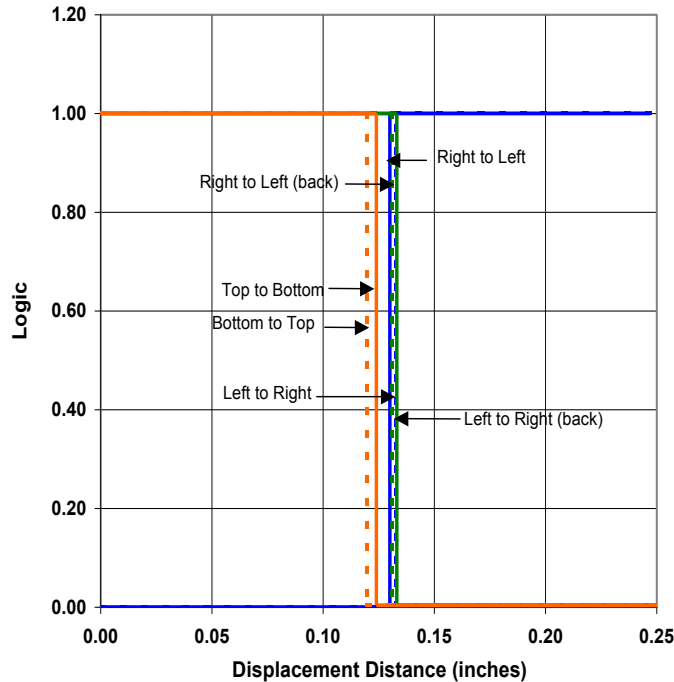

OPB930\_51, OPB940\_51 - Flag in Middle of Slot

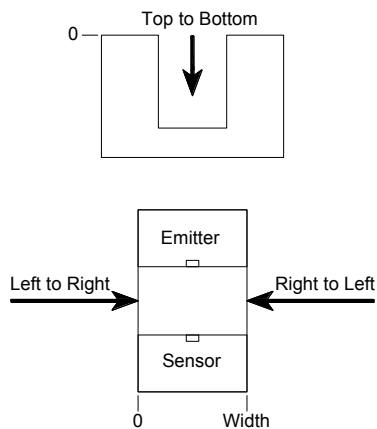
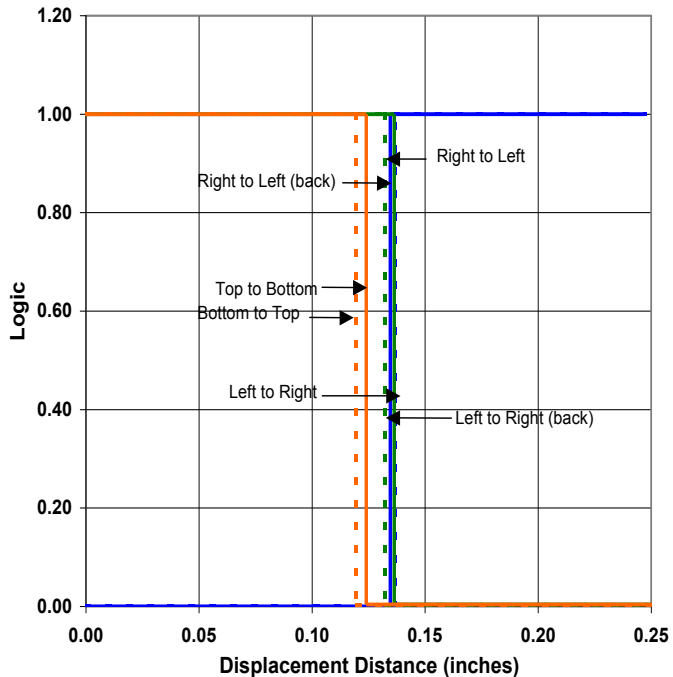

General Note  
TT Electronics reserves the right to make changes in product specification without notice or liability. All information is subject to TT Electronics' own data and is considered accurate at time of going to print.

OPTEK Technology, Inc.  
1645 Wallace Drive, Carrollton, TX 75006 | Ph: +1 972 323 2200  
www.optekinc.com | www.ttelectronics.com

# Photologic<sup>®</sup> Slotted Optical Switch

## OPB930 and OPB940 (L and W Series)



**OPB930\_55, OPB940\_55 - Flag Next to Emitter**

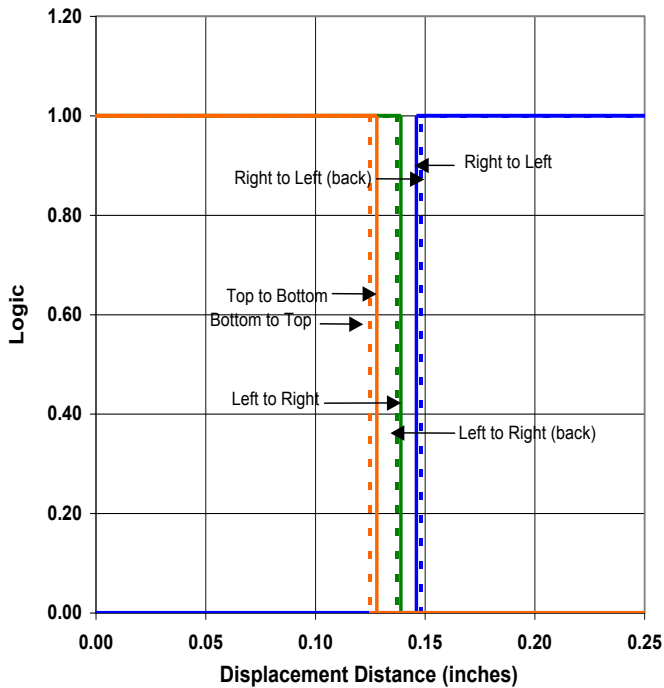

**OPB930\_55, OPB940\_55 - Flag Next to Sensor**

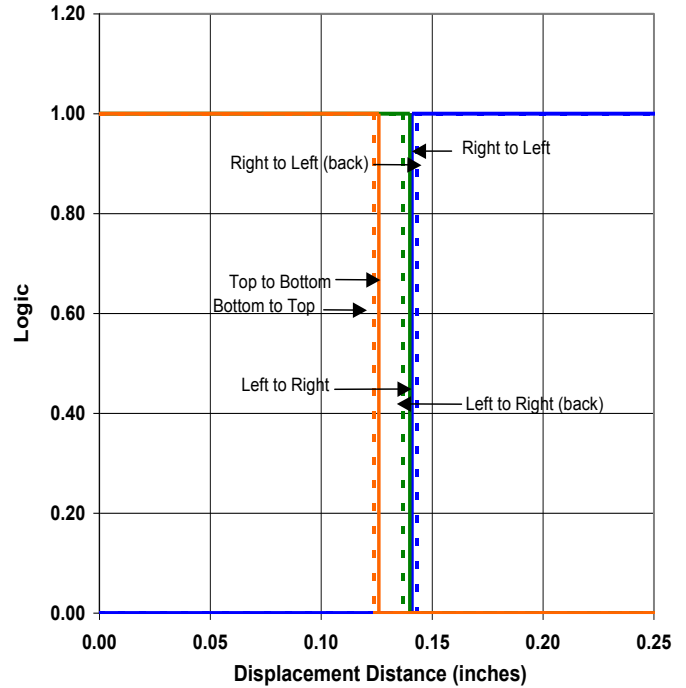

**OPB930\_55, OPB940\_55 - Flag in Middle of Slot**

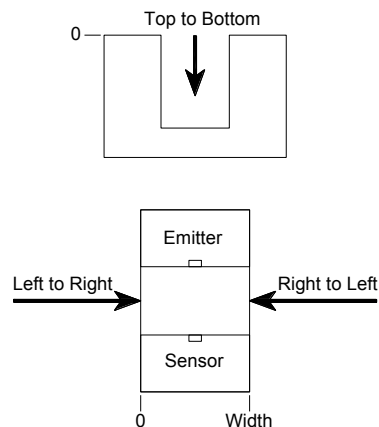
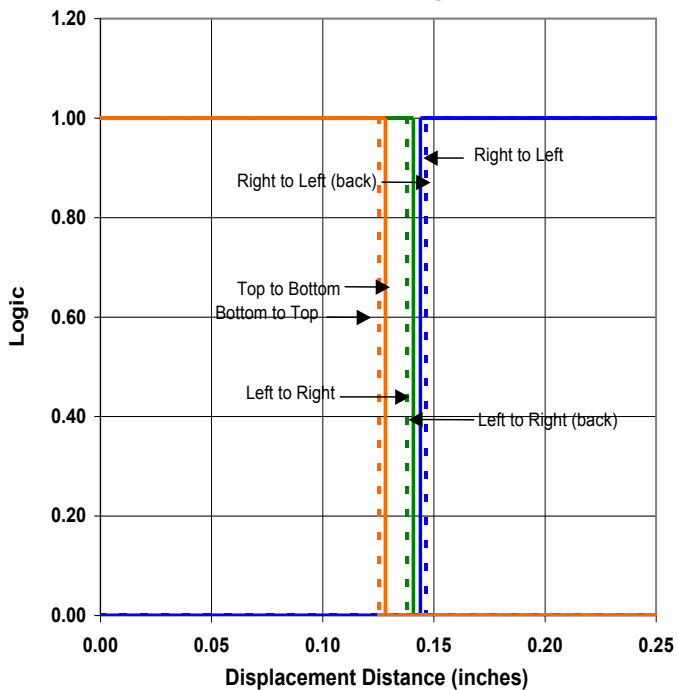

General Note  
TT Electronics reserves the right to make changes in product specification without notice or liability. All information is subject to TT Electronics' own data and is considered accurate at time of going to print.

OPTEK Technology, Inc.  
1645 Wallace Drive, Carrollton, TX 75006 | Ph: +1 972 323 2200  
www.optekinc.com | www.ttelectronics.com