

CAD FILE:

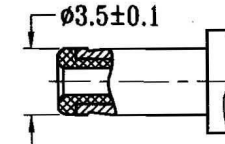

PLUG

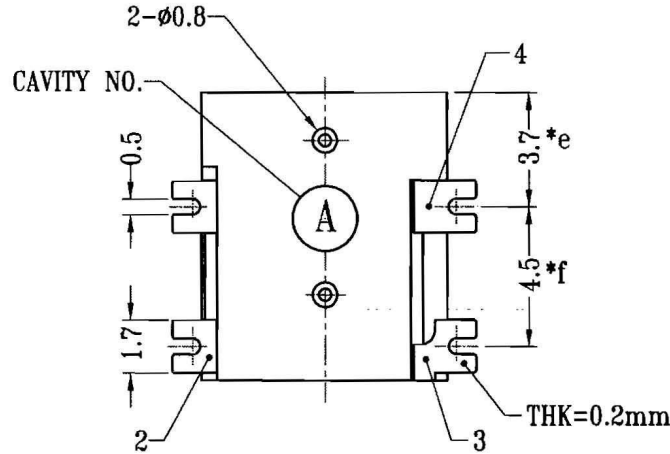
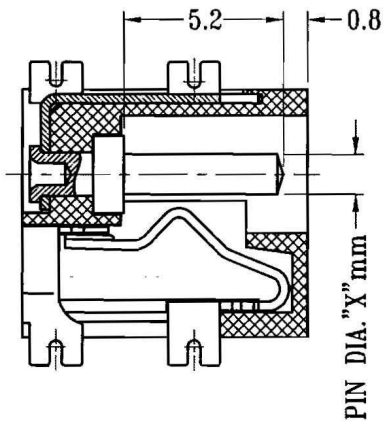
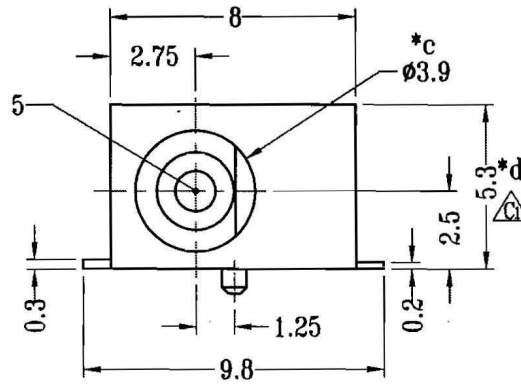
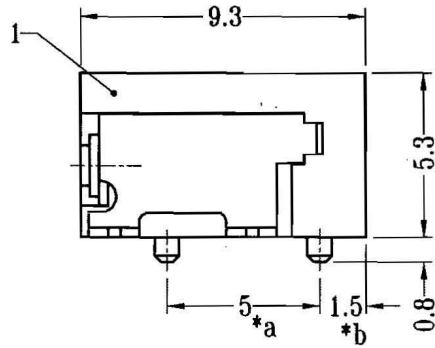
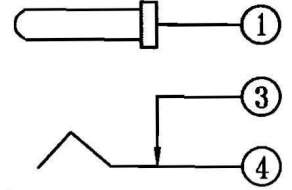

SCHEMATIC

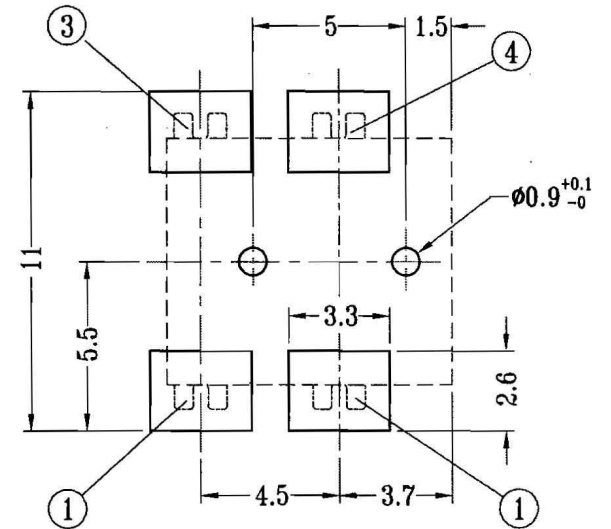

P.C.B LAYOUT

DIA OF PIN 'X' B=0.65mm  
 Dia. OF PIN "X" E=1.0mm  
 Dia. OF PIN "X" D=1.3mm

注：“\*”表示关键尺寸(6个).

				TOLERANCE UNLESS SPECIFIED									
				WITHIN 1.5mm : ±0.1mm	D	23-Nov-2007	原数为: 5.5						
				OVER 1.5mm : ±0.2mm	ISSUE	DATE	DESCRIPTIONS OF REVISION		APPD.				
5	PLUG PIN	BRASS	1	Ni PLATED	TITLE : DC POWER JACK MODEL: K372050B SHALLIN ELECTRONICS CO., LTD.				UNIT : mm		DRWG NO.:		
4	SPRING TERMINAL C	SUS	1	Ag PLATED OVER Ni PLATED					SCALE: 4:1		DWN.	陈强	23-Nov-2007
3	TERMINAL A	BRASS STRIP	1	Ag PLATED OVER Ni PLATED					CHK'D	江永军	23-Nov-2007		
2	TERMINAL B	BRASS STRIP	1	Ag PLATED OVER Ni PLATED					APPD.	黄文傑	23-Nov-2007		
1	CASE	PA46/PA9T	1	BLACK									
NO.	PARTS	MATERIALS	QTY	FINISH									