

# Digital Oscilloscope & Multimeter

GDS-122

## USER MANUAL

GW INSTEK PART NO.



ISO-9001 CERTIFIED MANUFACTURER

**GW INSTEK**

March 2012 edition

This manual contains proprietary information, which is protected by copyrights. All rights are reserved. No part of this manual may be photocopied, reproduced or translated to another language without prior written consent of Good Will company.

The information in this manual was correct at the time of printing. However, Good Will continues to improve products and reserves the rights to change specification, equipment, and maintenance procedures at any time without notice.

*Windows is a registered trademark of Microsoft Corporation in the United States and other countries.*

Good Will Instrument Co., Ltd.  
No. 7-1, Jhongsing Rd., Tucheng Dist., New Taipei City 236, Taiwan

# TABLE OF CONTENTS

|  |           |
|--|-----------|
| <b>Safety Instructions</b> .....                     | <b>6</b>  |
| <b>Getting Started</b> .....                         | <b>9</b>  |
| Package Contents .....                               | 10        |
| Main Features.....                                   | 11        |
| Front Panel and Keys Overview .....                  | 12        |
| Manual Overview .....                                | 14        |
| <b>Using the Oscilloscope</b> .....                  | <b>15</b> |
| Basic Operations.....                                | 16        |
| 1. Powering up the GDS-122.....                      | 16        |
| 2. Connecting an input signal .....                  | 17        |
| 3. Using the Autoset function.....                   | 18        |
| 4. Introducing the display contents .....            | 19        |
| 5. Adjusting waveform scales.....                    | 20        |
| 6. Adjusting waveform positions.....                 | 21        |
| Configurations .....                                 | 22        |
| Configuring channel (vertical) settings .....        | 22        |
| Configuring horizontal settings.....                 | 25        |
| Configuring trigger settings: general settings ..... | 27        |
| Configuring trigger settings: edge triggering .....  | 30        |
| Configuring trigger settings: video triggering ..... | 33        |
| Selecting the acquisition mode.....                  | 35        |
| Configuring display settings .....                   | 36        |
| Viewing the system status.....                       | 37        |
| Measurements .....                                   | 39        |
| Running waveform maths.....                          | 39        |
| Running automatic measurements .....                 | 41        |
| Running time cursor measurements.....                | 42        |
| Running voltage cursor measurements .....            | 43        |
| Advanced Viewings .....                              | 45        |
| Zooming waveforms horizontally .....                 | 45        |

|   |           |
|---|-----------|
| Viewing waveforms in X-Y format .....                 | 47        |
| Viewing signal peaks .....                            | 48        |
| Viewing noisy signals.....                            | 49        |
| Viewing variations in a signal.....                   | 50        |
| Calibration .....                                     | 51        |
| Running the self calibration .....                    | 51        |
| Running the probe calibration.....                    | 52        |
| Saving/Recalling Waves and Settings .....             | 53        |
| Recalling the default settings.....                   | 53        |
| Saving waveforms .....                                | 54        |
| Recalling waveforms .....                             | 55        |
| Menu Tree / Operation Shortcuts .....                 | 56        |
| Trigger .....   | 56        |
| CH1/CH2 Setup .....                                   | 56        |
| Measurement Setup 1/2.....                            | 57        |
| Wave Math .....                                       | 57        |
| Cursor Measurement.....                               | 57        |
| Acquisition Mode .....                                | 58        |
| Time Mode.....  | 58        |
| Function .....  | 58        |
| Display .....   | 58        |
| Wave Save .....                                       | 59        |
| System Status .....                                   | 59        |
| OSC OPTION key .....                                  | 60        |
| Using the Software .....                              | 61        |
| Installing the software .....                         | 62        |
| Modifying/Reinstalling/Uninstalling the software..... | 64        |
| Activating the software and connecting the GDS-122 .. | 65        |
| Configuring the screen .....                          | 68        |
| Viewing the waveforms .....                           | 71        |
| Using the cursor measurements.....                    | 75        |
| Saving waveforms .....                                | 77        |
| Recalling waveforms .....                             | 79        |
| Printing out waveforms .....                          | 80        |
| Accessing the Help .....                              | 82        |
| <b>Using the Multimeter</b> .....                     | <b>83</b> |
| Activating the Multimeter .....                       | 84        |

Measuring Voltage ..... 85

Measuring Current ..... 87

Measuring Impedance ..... 89

Measuring Diode ..... 91

Measuring Continuity ..... 92

Measuring Capacitance ..... 93

**Faq..... 95**

**Specifications..... 97**

    Oscilloscope specifications ..... 97

    Multimeter specifications ..... 98

    General specifications ..... 99

**Declaration of Conformity ..... 100**







**Index..... 101**

# SAFETY INSTRUCTIONS

This chapter contains important safety instructions that you should follow when operating the instrument and when keeping it in storage. Read the following before any operation to ensure your safety and to keep the instrument in best condition.

## Safety Symbols

These symbols may appear in this manual or on the instrument.

|  |                |   |
|--|----------------|---|
|   | <b>WARNING</b> | Warning: Identifies conditions or practices that could result in injury or loss of life.                          |
|   | <b>CAUTION</b> | Caution: Identifies conditions or practices that could result in damage to the instrument or to other properties. |
|   |                | <b>DANGER: High Voltage</b>   |
|   |                | Attention: Refer to the Manual  |
|   |                | Protective Conductor Terminal   |
|  |                | Earth (ground) Terminal   |

## Safety Guidelines

- General Guidelines
- Do not place heavy objects on the instrument.
  - Avoid severe impacts or rough handlings that may damage the instrument.
  - Avoid discharges of static electricity onto or near the instrument.
  - Do not insert bare wires or metal objects into the terminals.
  - Do not apply input voltage more than 42V peak (30Vrms) to the instrument.
-  **CAUTION**

- Do not perform measurements at a power generating source or building installation site (see note below).
- The instrument should only be disassembled by a qualified technician.

(Measurement categories) EN 61010-1:2001 specifies the measurement categories and their requirements as follows. This instrument falls under category I. Measurement category IV is for measurement performed at the source of low-voltage installation. Measurement category III is for measurement performed in the building installation. Measurement category II is for measurement performed on the circuits directly connected to the low voltage installation. Measurement category I is for measurements performed on circuits not directly connected to Mains.

**Power Supply**



**WARNING**

- AC Input voltage: 100 to 240V, 50/60Hz
- The power supply voltage should not fluctuate more than 10%.
- Always use the AC adaptor included in the package.
- Always connect the AC adaptor to the mains line first, then to the instrument.

**Cleaning the instrument**

- Disconnect the power cord before cleaning the instrument.
- Use a soft cloth dampened in a solution of mild detergent and water. Do not spray liquid into the instrument.
- Do not use chemicals or cleaners containing harsh products such as benzene, toluene, xylene, and acetone.

**Operation Environment**

- Location: Indoor, no direct sunlight, dust free, most non-conductive pollution (see note below)
- Relative Humidity: < 75%
- Altitude: < 2000m
- Temperature: 0°C to 40°C

(Pollution Degree) EN 61010-1:2001 specifies the pollution degrees and their requirements as follows. This instrument falls under degree 2. Pollution refers to "addition of foreign matter, solid, liquid, or gaseous (ionized gases), that may produce a reduction of dielectric strength or surface resistivity".

Pollution degree 1: No pollution or only dry, non-conductive pollution occurs. The pollution has no influence.

Pollution degree 2: Normally only non-conductive pollution occurs.

Occasionally, however, a temporary conductivity caused by condensation must be expected.

Pollution degree 3: Conductive pollution occurs, or dry, non-conductive pollution occurs which becomes conductive due to condensation which is expected. In such conditions, equipment is normally protected against exposure to direct sunlight, precipitation, and full wind pressure, but neither temperature nor humidity is controlled.

**Storage environment**

- Location: Indoor
- Relative Humidity: < 75%
- Temperature: -10°C to 70°C

**Power cord for the United Kingdom**

When using the instrument in the United Kingdom, make sure the power cord meets the following safety instructions.

NOTE: This lead/appliance must only be wired by competent persons

**⚠WARNING: THIS APPLIANCE MUST BE EARTHED**

IMPORTANT: The wires in this lead are coloured in accordance with the following code:

- Green/ Yellow: Earth
- Blue: Neutral
- Brown: Live (Phase)



As the colours of the wires in main leads may not correspond with the colours marking identified in your plug/appliance, proceed as follows:

The wire which is coloured Green & Yellow must be connected to the Earth terminal marked with the letter E or by the earth symbol ⊕ or coloured Green or Green & Yellow.

The wire which is coloured Blue must be connected to the terminal which is marked with the letter N or coloured Blue or Black.

The wire which is coloured Brown must be connected to the terminal marked with the letter L or P or coloured Brown or Red.

If in doubt, consult the instructions provided with the equipment or contact the supplier.

This cable/appliance should be protected by a suitably rated and approved HBC mains fuse: refer to the rating information on the equipment and/or user instructions for details. As a guide, cable of 0.75mm<sup>2</sup> should be protected by a 3A or 5A fuse. Larger conductors would normally require 13A types, depending on the connection method used.

Any exposed wiring from a cable, plug or connection that is engaged in a live socket is extremely hazardous. If a cable or plug is deemed hazardous, turn off the mains power and remove the cable, any fuses and fuse assemblies. All hazardous wiring must be immediately destroyed and replaced in accordance to the above standard.









# GETTING STARTED

This chapter gives you an overview of what the GDS-122 is about, what items are included in the package, and how the user manual is organized. After opening the GDS-122 package, check the contents referring to the *Package Contents* section, then learn the features and interface reading the *Main Features* and *Front Panel and Keys Overview* section. The Manual Overview section gives you an overall picture of what each chapter is about, helping you directly jump to the relevant location.

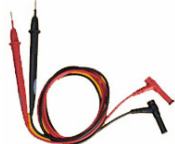

|                                     |    |
|-------------------------------------|----|
| Package Contents .....              | 10 |
| Main Features .....                 | 11 |
| Front Panel and Keys Overview ..... | 12 |
| Manual Overview .....               | 14 |

## Package Contents

|  |  |
|--|--|
| <p>Soft carrying case</p>                               | <p>GDS-122</p>    |
| <p>AC-DC adaptor</p>                                    | <p>Oscilloscope probe x 2 + probe adjustment tools</p>      |
| <p>1kHz square wave output cable</p>                    | <p>Multimeter test lead x 2</p>                             |
| <p>Extension module for large current measurement</p>  | <p>Extension module for small capacitance measurement</p>  |
| <p>USB communication cable</p>                        | <p>CD-ROM (software)</p>   |
| <p>User Manual (this document)</p>   | <p>RS-232C communication cable (optional item - contact Good Will)</p>   |

## Main Features

|              |  |
|--------------|--|
| Oscilloscope | <ul style="list-style-type: none"> <li>• Dual channel</li> <li>• 20MHz bandwidth</li> <li>• 100MS/s real-time sampling rate</li> <li>• ≤ 17.5ns rising time</li> <li>• 5ns to 5s/div horizontal scale</li> <li>• 5mV to 5V/div vertical scale</li> <li>• 6k memory points per channel</li> <li>• Isolated inputs between oscilloscope and multimeter</li> <li>• Autoset function</li> <li>• Trigger mode: Auto, Free run, Single shot, Edge, Video</li> <li>• 2 cursors</li> <li>• 5 automatic measurements</li> <li>• 4 display image memories</li> <li>• Auto-calibration</li> </ul> |
| Multimeter   | <ul style="list-style-type: none"> <li>• Volts, Amps, Ohms, Continuity, Diode, Capacitance measurement</li> <li>• 20A maximum amplitude</li> <li>• True RMS measurement</li> <li>• Isolated inputs between oscilloscope and multimeter</li> </ul>  |
| Common       | <ul style="list-style-type: none"> <li>• USB interface</li> <li>• RS-232C interface</li> <li>• 1kHz square wave output</li> <li>• 3.8 inch color LCD display, 320 x 240 resolution</li> <li>• 6 hours running time Li-ion battery</li> <li>• 180mm x 113mm x 40mm compact size</li> <li>• 690g light weight</li> </ul>   |

## Front Panel and Keys Overview

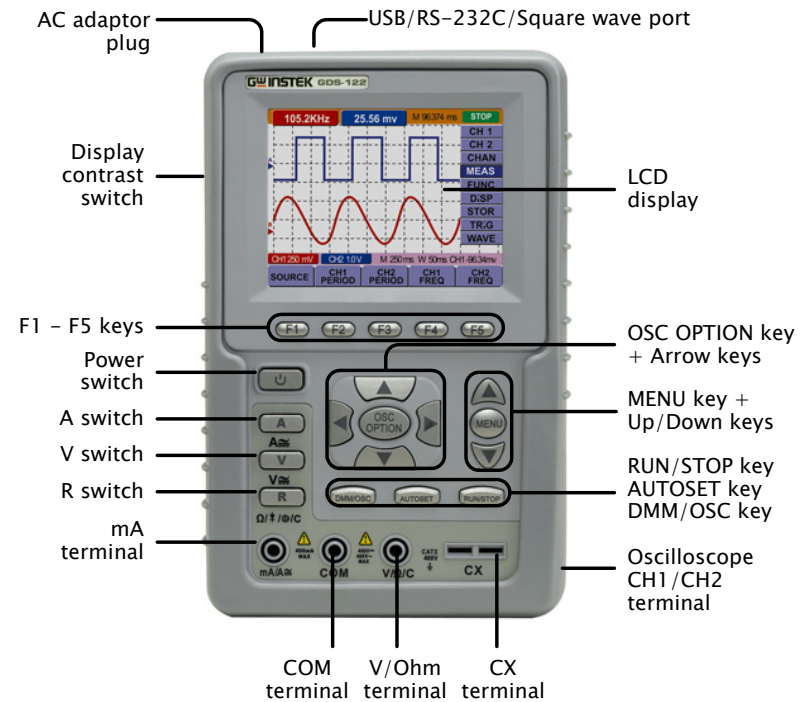

|                             |   |  |                       |
|-----------------------------|---|--|-----------------------|
| <b>DSO</b>                  | : Oscilloscope function   | <b>DMM</b>   | : Multimeter function |
| AC adaptor plug             | Accepts the AC adaptor cord. DC 8.5V, 1500mA.                                 |  |                       |
| USB port                    | Accepts the USB cable for PC connection.                                      |  |                       |
| RS-232C port                | Accepts the optional RS-232C cable for PC connection.                         |  |                       |
| Square wave output          | Outputs a 1kHz square wave for probe compensation and other general purposes. |  |                       |
| LCD display                 | 3.8 inch, 320 x 240 resolution, color LCD display.                            |  |                       |
| OSC OPTION key + Arrow keys | <b>DSO</b>  | Sets the following parameters: vertical level and scale (page22), horizontal level and scale (page25), trigger level (page25), and cursor position (page42). |                       |

|                         |            |  |
|-------------------------|------------|--|
| MENU key + Up/Down keys | <b>DSO</b> | Activates the side menu and selects the menu items.  |
| RUN/STOP key            | <b>DSO</b> | Manually turns on (run) or off (stop) the trigger. For details, see page25.  |
| RUN/STOP key            | <b>DMM</b> | Freezes (stop) or unfreezes (run) the measurement.   |
| AUTOSET key             | <b>DSO</b> | Automatically selects the horizontal scale, vertical scale, and trigger level according to the input signal. See page18 for details. |
|                         | <b>DMM</b> | Switches the measurement mode. For details, see page87(current), page85(voltage), and page89(impedance).                             |
| DMM/OSC key             |            | Switches the operation mode between the oscilloscope and multimeter.   |
| CH1 /2 terminal         | <b>DSO</b> | Accepts the CH1 and CH2 input signal.  |
| CX terminal             | <b>DMM</b> | Accepts the test leads for capacitor measurement.  |
| V/ $\Omega$ terminal    | <b>DMM</b> | Accepts the red lead for voltage, small capacitance, and impedance measurements.   |
| COM terminal            | <b>DMM</b> | Accepts the black (ground) lead.   |
| mA terminal             | <b>DMM</b> | Accepts the red lead for current measurement.  |
| R switch                | <b>DMM</b> | Selects the following measurement: impedance (page89), diode (page91), continuity (page92), capacitance (page93).                    |
| V switch                | <b>DMM</b> | Selects voltage measurements (page85).   |
| A switch                | <b>DMM</b> | Selects current measurements (page87).   |
| Power switch            |            | Turns on or off the GDS-122 power.   |
| F1 – F5 keys            |            | Selects the menu item at the bottom of the display.  |
| Disp contrast sw        |            | Selects the display contrast.  |

## Manual Overview

|                                     |  |
|-------------------------------------|--|
| Overview                            | This user manual is comprised of seven chapters. If you want to jump start using the GDS-122, go directly to the <i>Using Oscilloscope</i> or <i>Using Multimeter</i> chapter.   |
| Safety Instructions (page6)         | The <i>Safety Instructions</i> gives you an overview of important safety-related issues which you should be aware of before, during, and after operations.   |
| Getting Started (page9)             | The <i>Getting Started</i> chapter provides you with the overview of the GDS-122: main features, package contents, front panel, and user manual (this section).  |
| Using the Oscilloscope (page15)     | The <i>Using the Oscilloscope</i> chapter describes in detail how to use the GDS-122's oscilloscope functionalities, including the PC software. The chapter starts with simple, basic operations toward more complex measurements and settings. If you are new to the GDS-122, start with the Basic Operations section. For advanced users, the <i>Menu Tree / Shortcuts</i> section shows the menu structures and all operations shortcuts. |
| Using the Multimeter (page83)       | The <i>Using the Multimeter</i> chapter describes how to use the GDS-122's multimeter functionalities. The most commonly used Voltage, Current, and Resistance sections are listed in the front.   |
| Faq (page95)                        | The <i>Faq</i> chapter lists major problems you might encounter during operations and how to fix or avoid them. Most issues are also listed in the relevant chapters throughout the document.  |
| Specifications (page97)             | The GDS-122 specifications are separated in oscilloscope, multimeter, and general parts.   |
| Declaration of conformity (page100) | The <i>Declaration of Conformity</i> chapter lists the safety and EMI/EMC standards to which the GDS-122 conforms.   |
| Index (page101)                     | The <i>Index</i> chapter lists most of the keywords used in this manual in an alphabetical order.  |

# USING THE OSCILLOSCOPE

This chapter describes the oscilloscope functionalities in the GDS-122: setting it up and measuring simple waveforms, using advanced measurement functions, and configuring the system settings. The menu tree section at the end gives you an overview of all functionalities and a quick access to each of them. For the multimeter functionalities, see page83.

---

|   |    |
|---|----|
| Basic Operations.....                     | 16 |
| Configurations .....                      | 22 |
| Measurements .....                        | 39 |
| Advanced Viewings .....                   | 45 |
| Calibration .....                         | 51 |
| Saving/Recalling Waves and Settings ..... | 53 |
| Menu Tree / Operation Shortcuts .....     | 56 |
| Using the Software.....                   | 61 |

## Basic Operations

---

**Operation flow** The *Basic Operations* section describes how to set up the GDS-122 and observe an input signal, step-by-step.

1. Powering up the GDS-122
2. Connecting an input signal
3. Using the Autoset / Introducing the display
4. Adjusting the scales
5. Adjusting the waveform position

---

**Advanced operations** For more advanced or detailed operations, see the following chapters.

- *Configurations* (page22)
- *Measurements* (page39)
- *Advanced Viewings* (page45)
- *Calibrations* (page51)

### 1. Powering up the GDS-122

---

1. Pressing the power switch Press the power switch. The welcome screen with the corporate logo appears on the display. 



To adjust the display brightness, press the switch on the side. The backlight turns on and off. 

---

2. Activating the oscilloscope Press any key (for example the MENU (Example) key) to enter the oscilloscope mode. See the battery level icon at the top left corner of the display and connect the 



power cord if the level is < 25%.



Switching the operation mode

If the multimeter screen appears, press the DMM/OSC key and change the mode to oscilloscope.



Tilt standing the GDS-122

Use the bar at the back to tilt stand the GDS-122 on a horizontal plane.



Note

If pressing the power switch does not turn on the GDS-122, the battery may need recharging. Connect the GDS-122 to the AC adaptor and recharge it for at least 15 minutes.

## 2. Connecting an input signal

1. Connecting the probe

Connect the probe(s) between the DUT (Device Under Test) and the CH1/2 inputs on the GDS-122.

Alternately, you may use the GDS-122's own 1kHz square wave output signal. Insert the signal cable (included in the package) to the output terminal.

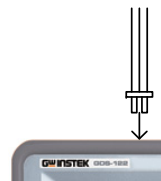

2. Setting the probe attenuation

To prevent excessive input voltage, we recommend you to set the probe attenuation level to the X 10 position to prevent excessive voltage.

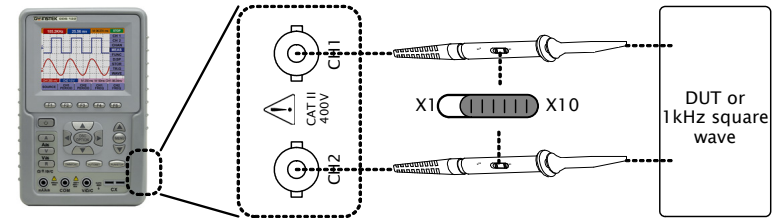

3. Setting the display magnification

1. After attenuating the probe level by x10, you also need to magnify the display level by x10 to match the displayed amplitude with the real amplitude. Open the CH1 or CH2 SETUP menu by pressing the MENU key and using the Up/Down keys.
2. Select the probe attenuation level (10X) by pressing F3 (Probe) repeatedly. The CH1/CH2 vertical scale indicator at the bottom left corner of the display changes accordingly.

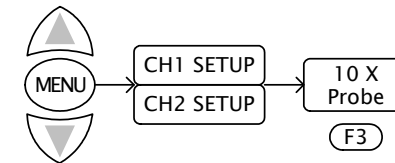

## 3. Using the Autoset function

Overview

The Autoset function automatically configures the following parameters according to the input signal.

- CH1/CH2 on/off
- Vertical scale/level
- Horizontal scale/level
- Trigger level

Using the Autoset function

Press the AUTOSET key. The input signal appears in the best display condition.



(Continued on next page)

Example

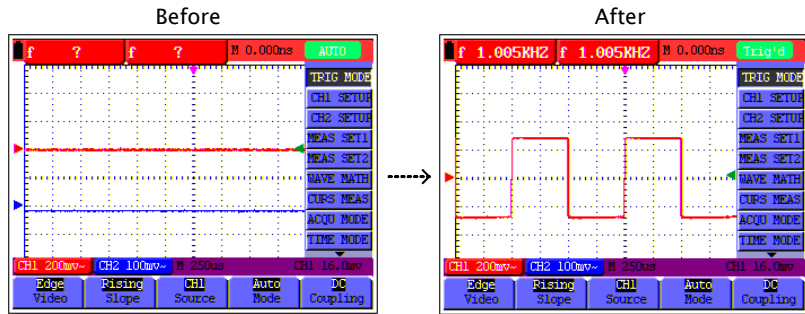

4. Introducing the display contents

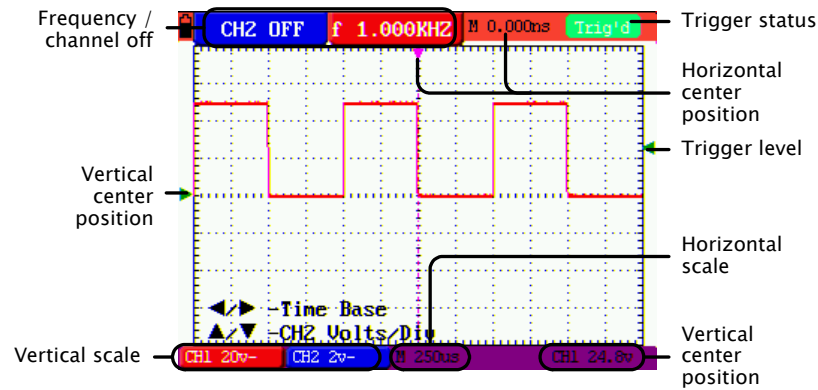

- Trigger status
- Updating the signal (auto mode) **AUTO**
  - The signal is triggered **Trig'd**
  - Waiting for trigger conditions **Ready**
  - Triggering is stopped **STOP**
- Press the RUN/STOP key to control trigger on/off (run/stop). **RUN/STOP**

5. Adjusting waveform scales

Selecting the menu

Press the OSC OPTION key repeatedly until the following menu appears on the display.

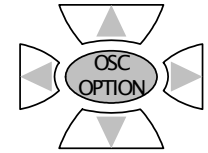

- ◀/▶ – Time Base
- ▲/▼ – CH1 (or CH2) Volts/Div



Vertical scale      Horizontal scale

Adjusting the horizontal scale

Use the Left/Right key to change the horizontal scale.

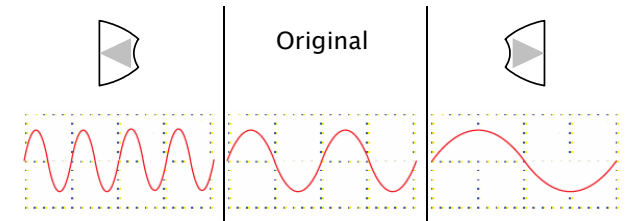

Adjusting the vertical scale

Use the Up/Down key to change the vertical scale.

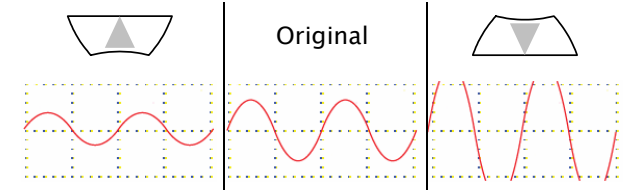

## 6. Adjusting waveform positions

Selecting the menu

Press the OSC OPTION key repeatedly until the following menu appears on the display.

◀/▶ – Time

▲/▼ – CH1 (or CH2) Zero

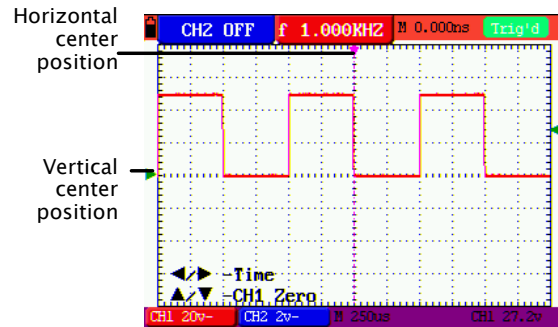
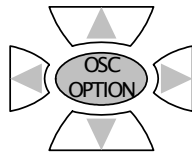

Adjusting the horizontal position

Use the Left/Right key to change the horizontal position.

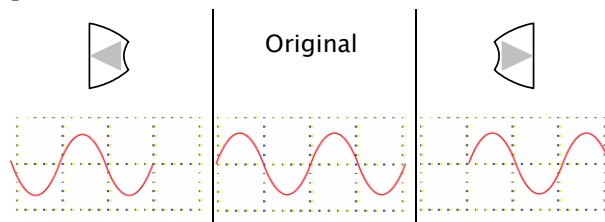

Adjusting the vertical position

Use the Up/Down key to change the vertical position.

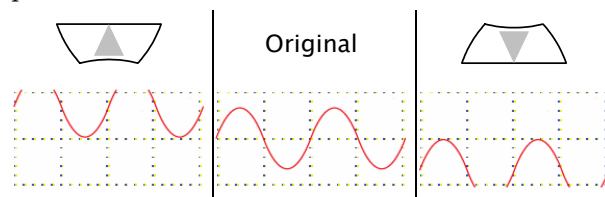

## Configurations

Overview

The configuration chapter describes how to change various GDS-122 internal parameters for allowing better measurement condition.

Configuration items

- Channel (vertical) settings page22
- Horizontal settings page25
- Trigger settings page25
- Acquisition modes page30
- Display settings page36
- System status (only for viewing) page37

### Configuring channel (vertical) settings

Overview

The channel settings configure how the waveform appears in terms of vertical or voltage scale.

**Position** Sets the vertical position of the waveform.

**Scale** Sets the vertical scale (volts per graticule). Range: 5mV/div to 5V/div

**CH on/off** Turns the channel on or off.

**Coupling** Selects AC or DC coupling. The DC coupling shows all signal elements, while the AC coupling filters out the DC component from the waveform.

**Inversion** Flips the waveform upside down.

**Magnification** Magnifies the displayed units (does not magnify the real signal). The magnification function is useful to align the displayed with probe attenuation (page17), especially X10.

Setting the vertical position

1. Press the OSC OPTION key repeatedly until the following menu appears on the display.  
 ◀/▶ - Time  
 ▲/▼ - CH1 (or CH2) Zero

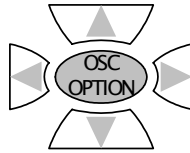

2. Use the Up/Down key to change the vertical position.

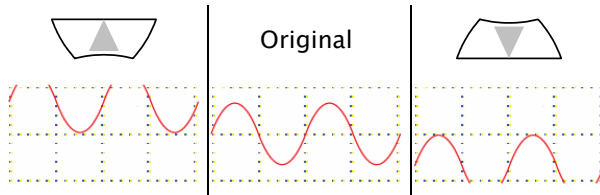

Setting the vertical scale

1. Press the OSC OPTION key repeatedly until the following menu appears on the display.  
 ◀/▶ - Time Base  
 ▲/▼ - CH1 (or 2) Volts/Div

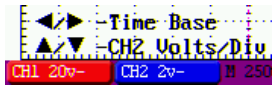
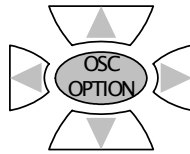

2. Use the Up/Down key to change the vertical scale.

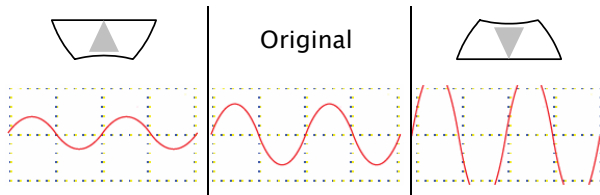

Turning the channel on/off

1. Press the MENU key and use the Up/Down keys to select the CH1(CH2) SETUP menu.
2. Press F2 (Channel) repeatedly to turn on or off the channel.

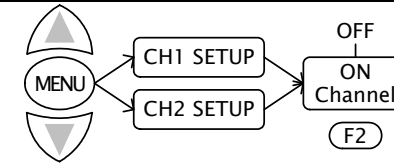

Note that when using the Autoset function (page18), channels are automatically turned on or off.

Selecting the coupling mode

1. Press the MENU key and use the Up/Down keys to select the CH1(CH2) SETUP menu.
2. Press F1 (Coupling) repeatedly to select DC, AC, or Ground coupling.

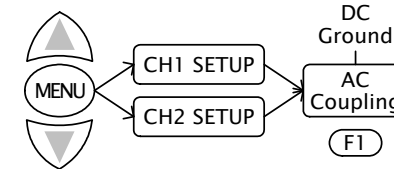

The DC coupling shows both DC and AC signal.

The AC coupling only shows the AC signal.

The Ground coupling shows the ground line.

DC coupling

(center point is at the bottom due to DC offset)

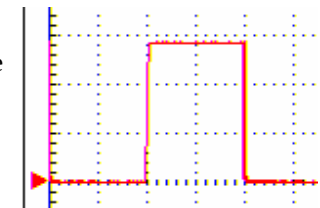

AC coupling

(center point is at the middle since the DC offset is being removed)

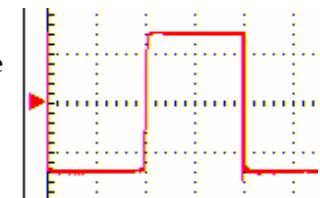

Inverting the channel

1. Press the MENU key and use the Up/Down keys to select the CH1(CH2) SETUP menu.
2. Press F4 (Inverted) to invert the waveform.

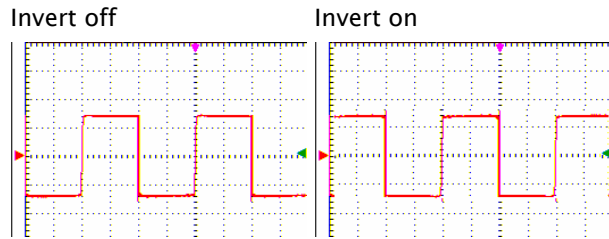
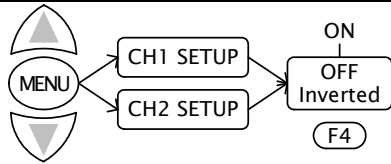

**Selecting the magnification**

1. Press the MENU key and use the Up/Down keys to select the CH1(CH2) SETUP menu.
2. Press F3 (Probe) repeatedly to select the probe magnification ratio.

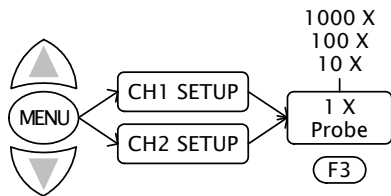

**Configuring horizontal settings**

|          |  |
|----------|--|
| Overview | The horizontal settings configure how the waveform appears in terms of horizontal or time scale. |
| Position | Sets the horizontal position of the waveform.  |
| Scale    | Sets the horizontal scale (time per graticule). Range: 100ms/s to 10s/s                          |

**Setting the horizontal position**

1. Press the OSC OPTION key repeatedly until the following menu appears on the display.  
◀/▶ – Time

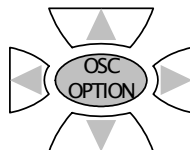

2. Use the Left/Right key to change the horizontal position.

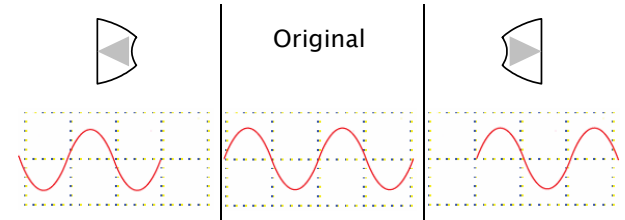

**Selecting the horizontal scale**

1. Press the OSC OPTION key repeatedly until the following menu appears on the display.

◀/▶ – Time Base

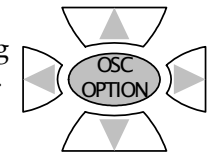
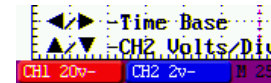



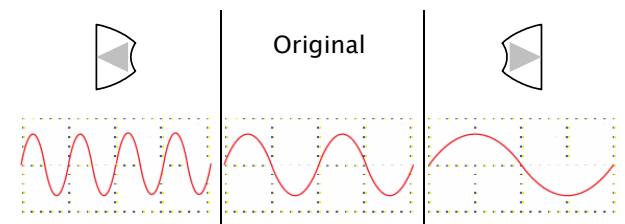

2. Use the Left/Right key to change the horizontal scale.



**Configuring trigger settings: general settings**



|          |   |
|----------|---|
| Overview | <p>The trigger settings configure how the incoming signal is triggered. The general settings section describes how to start and stop triggering, adjust the level, and change the trigger mode.</p> <ul style="list-style-type: none"> <li>For edge triggering details, see page30.</li> <li>For video triggering details, see page33.</li> </ul> |
| Status   | Shows the triggering status in the icon appearing in the upper right corner of the display.   |
| Run/Stop | Controls starting and stopping the trigger.   |
| Level    | Adjusts the vertical and horizontal level on which the waveforms are triggered.   |

|                |  |
|----------------|--|
| Trigger status | <p>The trigger status icon is located at the top right corner of the display.</p> <ul style="list-style-type: none"> <li> The trigger condition is met.</li> <li> The GDS-122 is showing the input signal waveform regardless of trigger condition. Available in the Auto trigger mode in edge triggering (page30).</li> <li> The trigger condition is not met, and the GDS-122 is waiting for the next condition. Available in the Normal trigger mode in edge triggering (page30).</li> <li> The GDS-122 is showing the input signal waveform regardless of trigger condition. The waveform is gradually updated from the left side of the display. The GDS-122 automatically switches to the Scan when the horizontal scale is at 100ms/div or longer.</li> <li> Triggering is stopped regardless of the trigger condition. In order to restart</li> </ul> |
|----------------|--|

triggering, you have to press the RUN/STOP key again (in single trigger mode) or switch to another trigger mode.

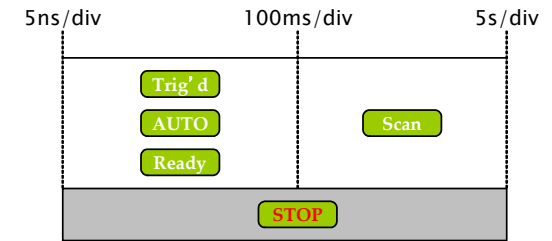
Horizontal scale vs. trigger status



Run/Stop Pressing the Run/Stop key once stops triggering at most situations and changes the trigger icon to STOP.  

In the single trigger mode in edge triggering (page30), pressing the RUN/STOP key works as both activating and deactivating trigger.

Trigger level Press the OSC OPTION key repeatedly until the following menu appears on the display. 



Trigger level indicators

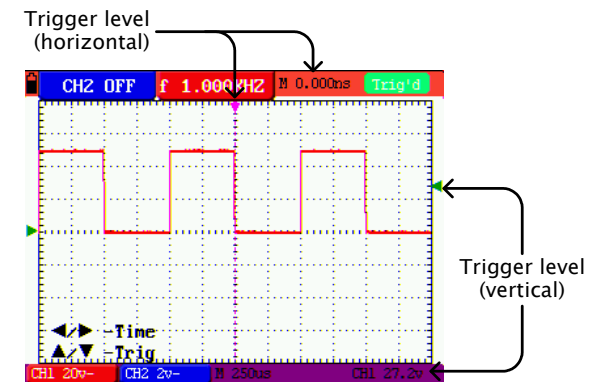

Use the arrow keys to change the triggering position.

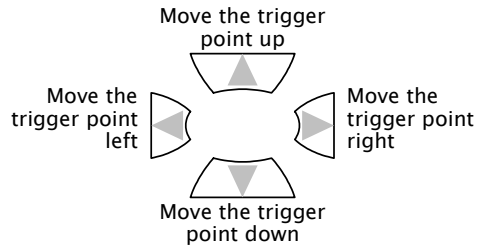

Pressing the Up and Down key together resets the vertical trigger level to zero.

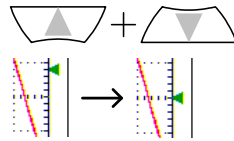

Pressing the Left and Right key together resets the horizontal trigger level to zero.

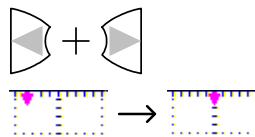

**Configuring trigger settings: edge triggering**

Overview

The edge trigger type triggers on the incoming signal edge. Use the edge trigger for all signals except for video related ones.

- For general trigger settings, see page27.
- For video triggering details, see page33.

To select edge triggering, follow these steps.

1. Press the MENU key and use the Up/Down keys to select TRIG MODE menu.
2. Press F1 (Type) to select the Edge trigger type.

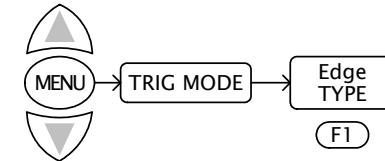

|          |  |
|----------|--|
| Slope    | Selects the slope, rising or falling, on which the GDS-122 triggers the input signals.   |
| Source   | Selects the signal source channel, CH1 or CH2.   |
| Mode     | Selects the triggering mode, Auto (acquires signal continuously), Normal (acquires signal when trigger conditions are met), and Single (manually triggers the signal). |
| Coupling | Selects the DC or AC coupling and rejection filters: high frequency or low frequency.  |

Selecting the trigger slope Press F2 (Slope) repeatedly to select the rising or falling slope.

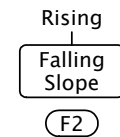

(Continues to the next page)

Example: falling edge

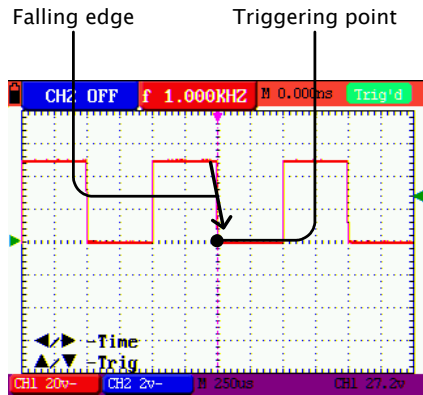

Selecting the source channel

Press F3 (Channel) repeatedly to select the trigger source channel, CH1 or CH2. The trigger channel indicator at the bottom right corner of the display changes.

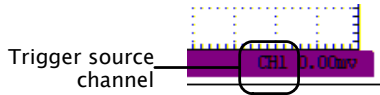
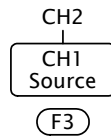

Selecting the trigger mode

Press F4 (Mode) repeatedly to select the trigger mode. The trigger status icon in the upper right corner of the display changes accordingly. For the overview of trigger status in general, see page27.

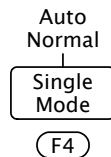

**Auto mode**

In the auto mode, input signals are constantly acquired and shown in the display regardless of trigger condition.

| Horizontal scale (/div)        | 5ns    | 100ms | 5s |
|--------------------------------|--------|-------|----|
| Status icon when triggered     | Trig'd | Scan  |    |
| Status icon when not triggered | AUTO   | Scan  |    |

**Normal mode**

In the normal mode, input signals are shown in the display only if the trigger condition is met.

| Horizontal scale (/div)        | 5ns    | 100ms | 5s |
|--------------------------------|--------|-------|----|
| Status icon when triggered     | Trig'd | Scan  |    |
| Status icon when not triggered | Ready  | Scan  |    |

**Single mode**

In the single mode, you manually trigger the GDS-122 by pressing the RUN/STOP key each time you need to observe the waveform. Once the waveform is captured, the GDS-122 stops triggering and waits for the next trigger command.

| Horizontal scale (/div)        | 5ns           | 100ms | 5s |
|--------------------------------|---------------|-------|----|
| Status icon when triggered     | STOP          | STOP  |    |
| Status icon when not triggered | AUTO<br>Ready | Scan  |    |

Selecting the coupling mode

Press F5 (Coupling) repeatedly to select the trigger coupling.

- AC: triggers only on the AC portion of the waveform.
- DC: triggers on the whole waveform (AC + DC).
- LF Rjc: filters out the lower frequency when triggering.
- HF Rjc: filters out the higher frequency when triggering.

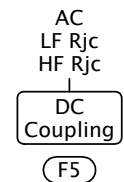



### Configuring trigger settings: video triggering

**Overview** The video trigger type is designed to capture the video signal format, NTSC, PAL, or SECAM. For any other signal type, use the edge trigger.

- For general trigger settings, see page27.
- For edge triggering details, see page30.

- To select edge triggering, follow these steps.
- Press the MENU key and use the Up/Down keys to select TRIG MODE menu.
  - Press F1 (Type) to select the video trigger type.

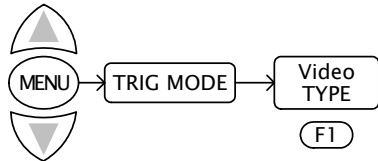

**Polarity** Selects the polarity of synchronization signal. Normal means the black level is low. Invert means the black level is high.

**Source** Selects the signal source channel, CH1 or CH2.

**Sync** Selects the part of the video signal used for synchronization: line or field.

**Selecting the trigger polarity** Press F2 (Polarity) repeatedly to select the polarity of synchronization signal.

- Normal: the black level is low.
- Inverted: the black level is high.

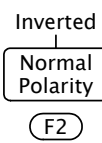

(Continues to the next page)

**Selecting the source channel** Press F3 (Channel) repeatedly to select the trigger source channel, CH1 or CH2. The trigger channel indicator at the bottom right corner of the display changes.

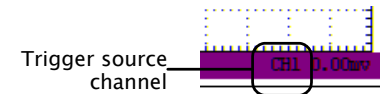
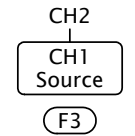

**Selecting the sync** Press F4 (Polarity) repeatedly to select the synchronization point.

- Line: the video line is used for triggering.
- Field: the video field is used for triggering.

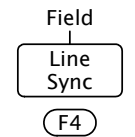

**Example**

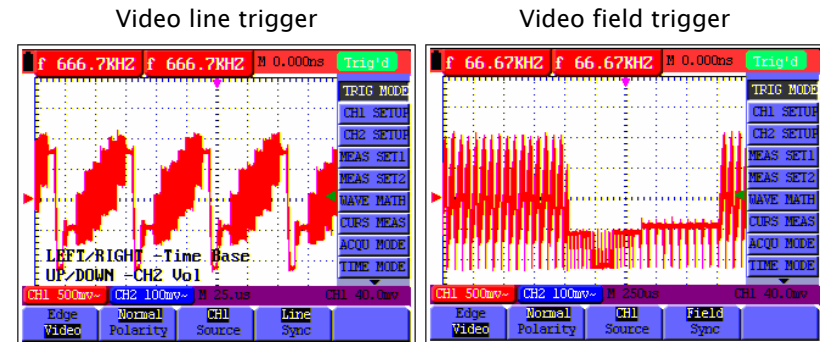

**Selecting the acquisition mode**

|             |  |
|-------------|--|
| Overview    | The acquisition mode specifies how the incoming analog signal is digitally sampled by the GDS-122.   |
| Sample      | The waveform data is sampled at an equal time interval. The sample mode accurately reconstructs the waveform, but cannot respond to rapid changes and sudden peaks.    |
| Peak detect | The maximum and minimum data in the sampling interval are picked up. The peak detect mode captures rapid changes and sudden peaks, but the waveform becomes noisy.     |
| Average     | Multiple samples are averaged together. The average mode reduces the noise level, but the waveform must be repetitive. The number of averaging are 4, 16, 64, and 128. |

Panel operations

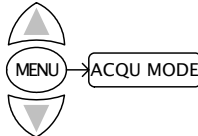
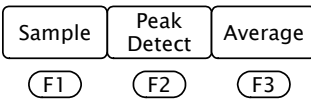
- Press the MENU key and select the ACQU MODE menu using the Up/Down keys.
 
- Select the acquisition mode from F1 (Sample) to F3 (Average).
 

For the Average mode, also press F4 (Averages) repeatedly to select the number of averaging: 4, 16, 64, or 128.

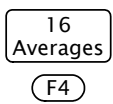
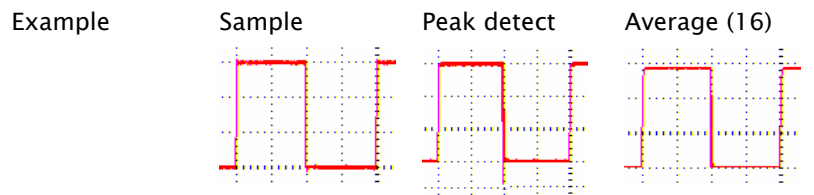
**Configuring display settings**

|                |  |
|----------------|--|
| Overview       | The display settings configure how the waveforms are drawn in the display.   |
| vector drawing | The vector drawing mode shows the waveform as a smooth line, connecting each data point.                                     |
| dot drawing    | The dot drawing mode shows the waveform as a collection of independent data points.  |
| persistence    | The persistence setting sets how long the old waveforms remain in the display, useful for observing the waveform variations. |

- Panel operations
- Press the MENU key and use the Up/Down keys to select the DISP SET menu.
  - Press F1 (Type) or F2 (Persist) repeatedly to select vector drawing, dot drawing, and persistence time.

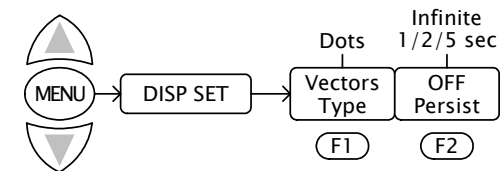

Vector/dot drawing example

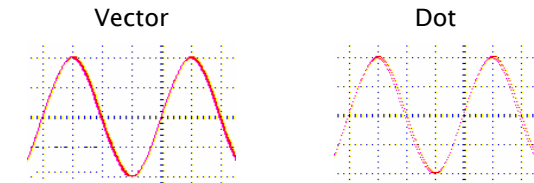

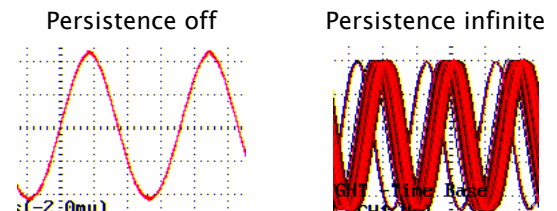

Persistence example

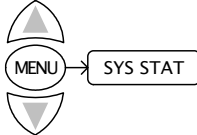
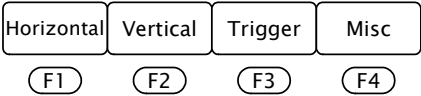

**Viewing the system status**

**Overview** The system status menu shows the GDS-122 system settings.

- Panel operations**
1. Press the MENU key and select the SYS STAT menu using the Up/Down keys.
 
  2. Select the status menu from F1 (Horizontal) to F4 (Misc) and press it. The status information appears in the display.
 
  3. To close the system status screen, select different menus using the MENU key followed by Up/Down keys.
 

**Horizontal status (F1)**

| HORIZONTAL SYSTEM STATUS |                |
|--------------------------|----------------|
| TIME BASE                | MAIN TIME BASE |
| MAIN SCALE               | 1.0ms          |
| WINDOW SCALE             | 10.us          |
| MAIN POSITION            | 300.0us        |
| WINDOW POSITION          | 559.60us       |
| DISPLAY FORMAT           | YT             |
| ACQUIRE MODE             | SAMPLE         |

For details of each item, see the following pages.  
 Time base: page25  
 Main/window scale: page45  
 Main/window position: page45  
 Display format: page47 (XY)  
 Acquire mode: page35

(Continues to the next page)

**Vertical status (F2)**

| VERTICAL SYSTEM STATUS |         |                  |
|------------------------|---------|------------------|
| SCALE                  | CH1     | 2.00v            |
| SCALE                  | CH2     | 50.0mv           |
| POSITION               | CH1     | 0.00 divs(0.0mv) |
| POSITION               | CH2     | 0.00 divs(0.0mv) |
| COUPLING               | CH1     | DC               |
| COUPLING               | CH2     | DC               |
| PROBE                  | CH1     | 1X               |
| PROBE                  | CH2     | 1X               |
| MATH                   | CH1-CH2 |                  |
| INVERTED               | CH1     | OFF              |
| INVERTED               | CH2     | OFF              |

For details of each item, see the following pages.  
 CH1/CH2 scale: page22  
 CH1/CH2 position: page22  
 CH1/CH2 coupling: page22  
 CH1/CH2 probe: page22  
 Math mode: page39  
 CH1/CH2 invert: page22

**Trigger status (F3): Edge trigger**

| TRIGGER SYSTEM STATUS |                |
|-----------------------|----------------|
| TYPE                  | EDGE           |
| SOURCE                | CH1            |
| SLOPE                 | RISING         |
| TRIGMODE              | SINGLE TRIGGER |
| COUPLING              | DC             |

For details of each item, see the following pages.  
 Trigger type: page30  
 Trigger source: page30  
 Trigger slope: page30  
 Trigger mode: page30  
 Trigger coupling: page30

**Trigger status (F3): Video trigger**

| TRIGGER SYSTEM STATUS |        |
|-----------------------|--------|
| TYPE                  | VIDEO  |
| SOURCE                | CH1    |
| POLARITY              | NORMAL |
| SYNC                  | LINE   |

For details of each item, see the following pages.  
 Trigger type: page33  
 Trigger source: page33  
 Trigger polarity: page33  
 Trigger sync: page33

**Misc status (F4)**

|               |
|---------------|
| MISC          |
| Series Number |
| 0739002       |
| Ver 3.0       |

The Misc status shows the serial number and firmware version.

## Measurements

**Overview** The advanced measurement functions allow you to automatically measure various parameters in a waveform.

- |                   |  |
|-------------------|--|
| Measurement items | <ul style="list-style-type: none"> <li>• Waveform math <span style="float: right;">page39</span></li> <li>• Automatic measurements <span style="float: right;">page41</span></li> <li>• Time cursor measurement <span style="float: right;">page42</span></li> <li>• Voltage cursor measurement <span style="float: right;">page43</span></li> </ul> |
|-------------------|--|

### Running waveform maths

**Overview** The waveform math function runs mathematical operations between CH1 and CH2 waveform, and then shows the result in the display.

- |           |  |
|-----------|--|
| Math type | <ul style="list-style-type: none"> <li>• CH1 – CH2 (subtract CH2 from CH1)</li> <li>• CH2 – CH1 (subtract CH1 from CH2)</li> <li>• CH1 + CH2 (add CH1 and CH2)</li> <li>• CH1 * CH2 (multiply CH1 and CH2)</li> <li>• CH1 / CH2 (divide CH1 by CH2)</li> </ul> |
|-----------|--|

**Panel operations** 1. Make sure that both CH1 and CH2 waveforms are shown in the display.

2. Press the MENU key and select the WAVE MATH menu using the Up/Down keys.

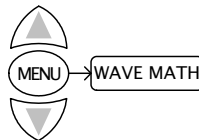

3. Select the math operation from F1 (CH1 – CH2) to F5 (CH1 / CH2) and press it.

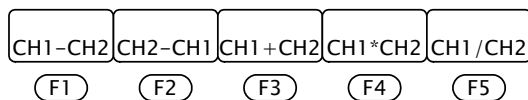

4. The math result appears in the display (example: adding two square waveforms)

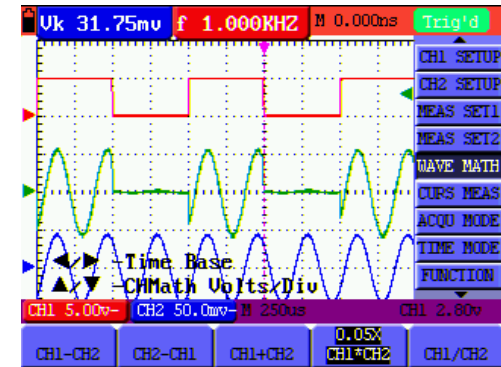

5. To cancel the math result, press the function key (F1 to F5) again.

**Changing the math result position**

1. Press the OSC OPTION key. Make sure the following menu appears on the display.



- ◀/▶ - Time
- ▲/▼ - CHM Zero



2. Use the arrow keys to move the math result position.

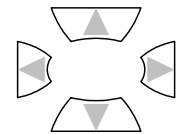

**Changing the math result scale**

1. Press the OSC OPTION key repeatedly until the following menu appears on the display.



- ◀/▶ - Time Base
- ▲/▼ - CHMath Volts/Div

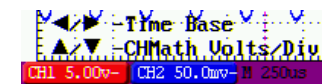

2. Use the arrow keys to change the math result scale.

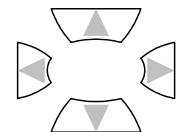

**Saving or recalling the math result**

The math result waveform can be saved into or recalled from one of the four GDS-122 internal memories. See page53 for details.

**Running automatic measurements**

|                   |   |
|-------------------|---|
| Overview          | The automatic measurement function measures the input signal's characteristics and lists them in the top left corner of the display.  |
| Source signal     | CH1, CH2  |
| Measurement set   | SET1, SET2  |
| Measurement items | <p>The following measurement items are available.</p> <ul style="list-style-type: none"> <li>• Frequency</li> <li>• Period</li> <li>• Mean voltage</li> <li>• Peak-to-peak voltage</li> <li>• Cycle voltage (true RMS)</li> </ul> |

Panel operations 1. Make sure that the waveform appears.

2. Press the MENU key and select the MEAS SET1 or SET2 menu using the Up/Down keys. SET1 and SET2 correspond to the results in the upper left corner of the display.

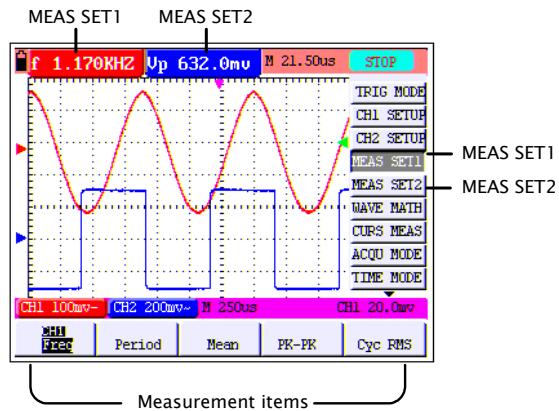
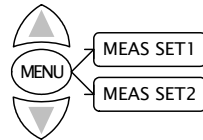

3. Select the measurement type from F1 (Freq) to

F5 (Cyc). Press it repeatedly to select CH1 or 2.

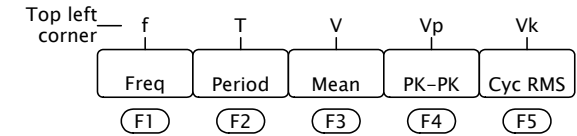

4. The measurement result appears in the top left corner of the display.

**Running time cursor measurements**

|          |   |
|----------|---|
| Overview | The time cursor function measures and updates the following three types of time difference. <ul style="list-style-type: none"> <li>• Between cursor 1 and cursor 2</li> <li>• Between cursor 1 and center (zero) point</li> <li>• Between cursor 2 and center (zero) point</li> </ul> |
|----------|---|

Time cursor panel operations 1. Make sure that the waveform appears.

2. Press the MENU key and select the CURS MEAS menu using the Up/Down keys.

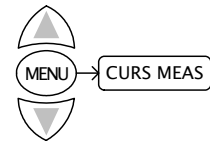

3. Press F1 (Type) repeatedly to select the Time cursor. The cursors appear as vertical purple lines located at the center of the display.

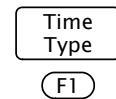

4. Press the OSC OPTION key repeatedly until the following menu appears.



◀/▶ - Time

▲/▼ - Cursor 1 (or 2)



5. Use the arrow keys to move the cursor or horizontal position.

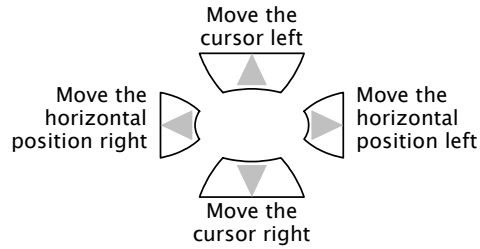

Display overview  
(CH1, cursor 2)

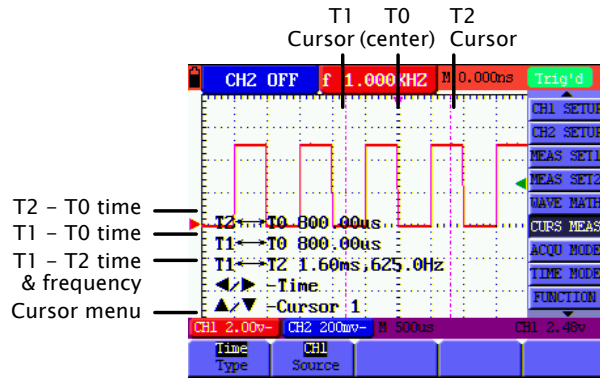

### Running voltage cursor measurements

Overview The voltage cursor function measures and updates the following five types of voltage difference.

- Between cursor 1 and cursor 2
- Between cursor 1 and CH1 center point
- Between cursor 2 and CH1 center point
- Between cursor 1 and CH2 center point
- Between cursor 2 and CH2 center point

Source signal CH1 input, CH2 input

Voltage cursor panel operations 1. Make sure the waveform appears.

2. Press the MENU key and select the CURS MEAS menu using the Up/Down keys.

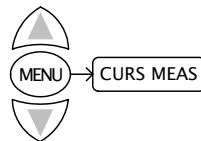

3. Press F1 (Type) repeatedly to select the Voltage cursor. The cursors appear as horizontal purple lines located at the center of the display.

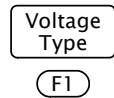

4. Press F2 (Source) repeatedly to select the source channel.

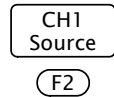

5. Press the OSC OPTION key repeatedly until the following menu appears.



◀/▶ - Time

▲/▼ - Cursor V1 (or V2)



6. Use the arrow keys to move the cursor or horizontal position.

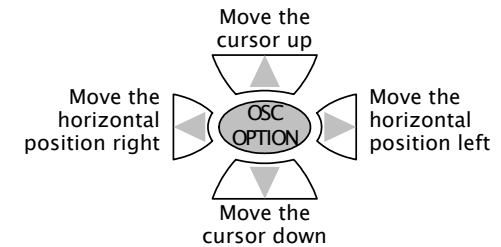

Display overview  
(CH1, cursor 2)

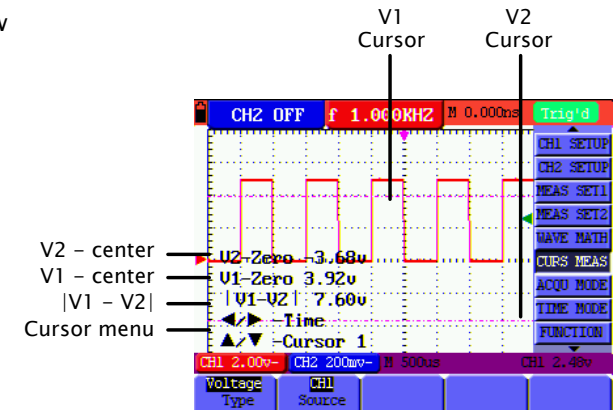

## Advanced Viewings

**Overview** The advanced viewing functions allow you to clearly observe specific type of waveforms and/or particular characteristics in a waveform.

- |               |  |
|---------------|--|
| Viewing items | <ul style="list-style-type: none"> <li>• Waveform zoom <span style="float: right;">page45</span></li> <li>• X-Y format <span style="float: right;">page47</span></li> <li>• Signal peaks <span style="float: right;">page48</span></li> <li>• Noisy signals <span style="float: right;">page48</span></li> <li>• Variations in a signal <span style="float: right;">page49</span></li> </ul> |
|---------------|--|

### Zooming waveforms horizontally

**Overview** By using the zoom function, you can magnify the waveform in the horizontal direction.

**Panel operations** 1. Make sure that the waveform appears in the display.

2. Press the MENU key and select the TIME MODE menu using the Up/Down keys.

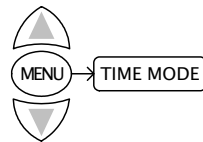

3. Press F2 (Set Window). A set of cursors appears in the center of the display.

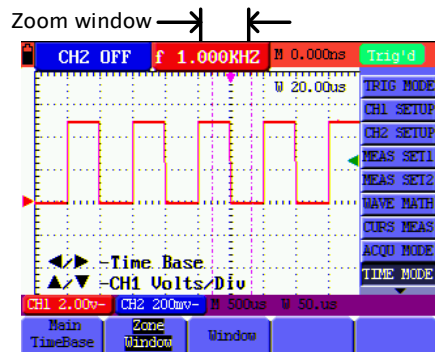
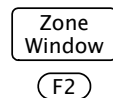

4. Press the OSC OPTION key repeatedly until the Time Base menu appears.



◀/▶ - Time

▲/▼ - Cursor V1 (or Cursor V2)



5. Use the arrow keys to change the zoom width.

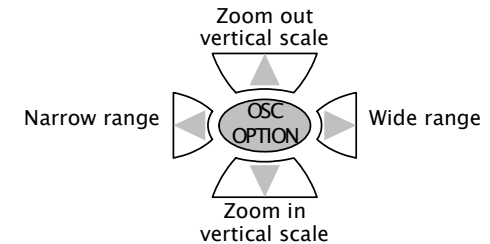

6. Press F3 (Window) to zoom into the window.

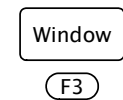

### Example

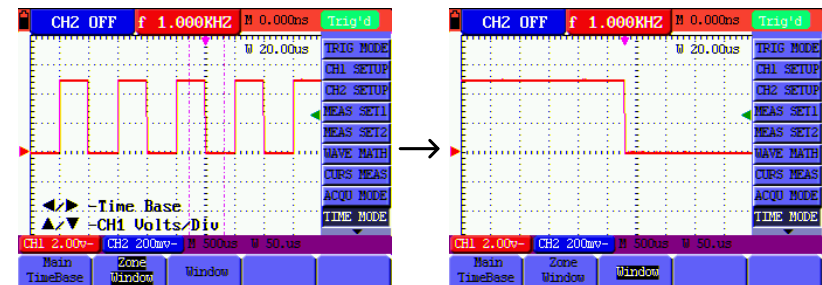

**Viewing waveforms in X-Y format**

**Overview** The X-Y format plots the CH1 input as X-axis and CH2 input as Y-axis. This display mode is convenient for viewing the phase relationship between CH1 and CH2.

**Panel operations** 1. Make sure that both CH1 and CH2 waveforms appear in the display.

2. Press the MENU key and select the DISP SET menu using the Up/Down keys.

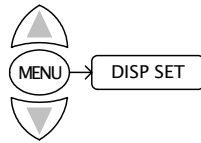

3. Press F3 (Format) and select XY. The display mode switches into the X-Y format.

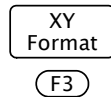

**Changing the scale and position** Press the OSC OPTION key repeatedly to access the menu listed below. In the X-Y mode, all scales and positions are controlled by the Up/Down keys.

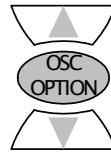

- CH1 Zero: horizontal position
- CH2 Zero: vertical position
- CH1 Vol: horizontal scale
- CH2 Vol: vertical scale

**Functions not applicable in the X-Y format** The following functions do not work in the X-Y format.

- Cursor measurement (page42, page43)
- Automatic measurement (page41)
- Window zoom (page45)
- Trigger settings configuration (page25)

**Viewing signal peaks**

**Overview** Using the peak detect acquisition mode, the maximum and minimum data in the sampling interval are displayed, capturing the rapid changes and sudden peaks that might spontaneously occur in a waveform.

**Note** Since the peak detect mode picks up the most extreme data, the waveform becomes noisier than the normal acquisition mode (sampling mode).

**Panel operations** 1. Press the MENU key and use the Up/Down keys to select ACQU MODE menu.  
2. Press F2 (Peak Detect) to activate the peak detect mode.

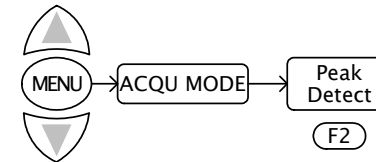

For other acquisition settings details, see page30.

**Example**

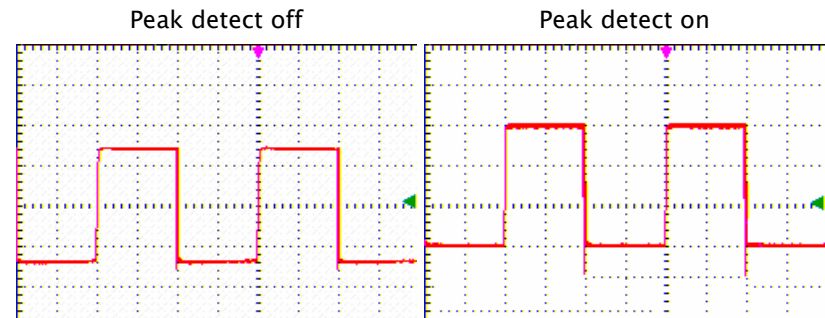



**Viewing noisy signals**

**Overview** Using the Average acquisition mode, you can smooth out the displayed waveform by averaging multiple data samples. The number of averaging is selectable from 4, 16, 64, and 128.

- Note**
- In order for the average mode to work in the best way, the waveform must be repetitive.
  - As the number of averaging increases, the slower the waveform update becomes.

- Panel operations**
1. Press the MENU key and use the Up/Down keys to select ACQU MODE menu.
  2. Press F3 (Average) to activate the average mode.
  3. Press F4 (Averages) repeatedly to select the number of averaging.

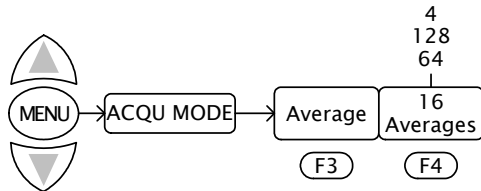

For other acquisition settings details, see page30.

**Example**



**Viewing variations in a signal**

**Overview** Using the persistence display function, you can define sets how long the old waveforms remain in the display, allowing observation of waveform variations. You can select the persistence time from 1, 2, and 5 sec. When choosing the Infinite mode, the GDS-122 keeps all past traces of the displayed waveform.

- Panel operations**
1. Press the MENU key and use the Up/Down keys to select DISP SET menu.
  2. Press F2 (Persist) repeatedly to select the persistence time.

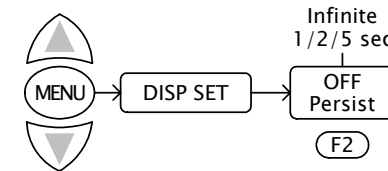

For other display settings details, see page36.

**Example**

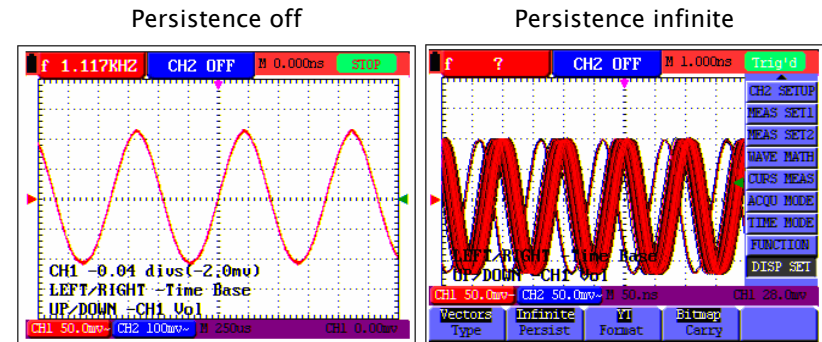

## Calibration



**Overview** The self calibration automatically adjusts the GDS-122 internal parameters. The probe calibration adjusts the probe capacitance. You should run both whenever using the GDS-122 in a new environment.

### Running the self calibration

**Overview** The self calibration function automatically configures internal parameters to maintain the sensitivity and accuracy. Run the self calibration in the following cases.

- When the temperature fluctuates more than 5 degrees Celsius during operations
- When operating the GDS-122 in a new benchtop or field environment

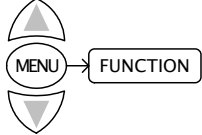
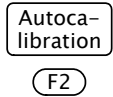
**Procedure**

1. Press the MENU key and select the FUNCTION menu using the Up/Down keys.
 
2. Press F2 (Autocalibration). A message appears on the display, asking you to remove all cables and probes from the GDS-122.
 
3. After removing all cables, press F2 (Autocalibration) again. The self-calibration automatically starts and a message appears, showing that the calibration is ongoing.
 
4. When the message disappears in 5 minutes, the calibration is completed.

**To interrupt calibration** Press any key during the calibration.

## Running the probe calibration

**Overview** The attached probe contains a calibration point at the end to adjust the waveform.

**Procedure**

1. You may use the GDS-122's own 1kHz square wave output signal. Insert the signal cable (included in the package) to the output terminal.

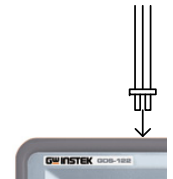

2. Use the Autoset function to put the waveform in the middle of the display.

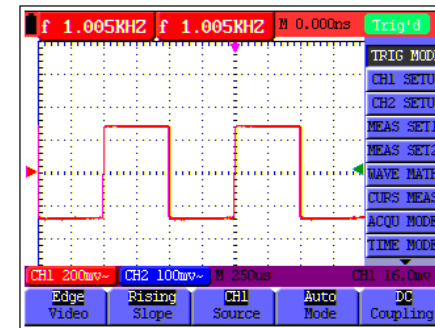

3. Adjust the probe calibration point to make sure that the waveform edge remains flat.

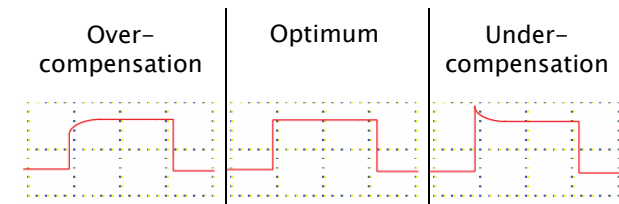
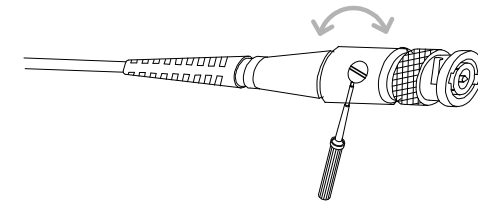

## Saving/Recalling Waves and Settings

**Overview** The GDS-122 can save or recall four sets of waveforms using its internal memory. When you need to reset the system, recall the default (factory installed) settings.

- |                   |                              |        |
|-------------------|------------------------------|--------|
| Save/recall items | • Recalling default settings | page53 |
|                   | • Saving waveforms           | page54 |
|                   | • Recalling waveforms        | page55 |

### Recalling the default settings

**Recalling the default settings** You can recall the default factory settings by pressing the MENU key, then selecting FUNCTION → F1 (Recall Factory).

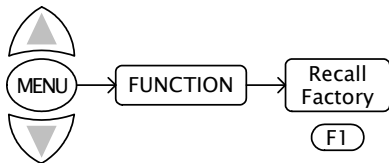

|                      |   |                                   |
|----------------------|---|-----------------------------------|
| <b>Trigger</b>       | Type: Edge<br>Source: CH1<br>Coupling: AC | Slope: Rising<br>Mode: Auto       |
| <b>CH1 &amp; CH2</b> | Coupling: AC<br>Probe scaling: 1 X        | Channel: ON<br>Invert: OFF        |
| <b>Measurement 1</b> | Item: CH1 frequency                       |                                   |
| <b>Measurement 2</b> | Item: CH2 frequency                       |                                   |
| <b>Cursor</b>        | Cursor: OFF                               | Channel: CH1                      |
| <b>Acquisition</b>   | Mode: Sample                              | Average number: 16                |
| <b>Time mode</b>     | Mode: Main timebase                       |                                   |
| <b>Display</b>       | Type: Vector<br>Format: YT                | Persistence: OFF<br>Carry: Bitmap |
| <b>Wave Save</b>     | Source: CH1<br>Display: OFF               | Waveform: A                       |

## Saving waveforms

**Overview** Up to four waveforms can be stored in and recalled from the GDS-122 internal memory. The stored waveform can be used for reference, comparison, or analysis.

**Memory** Four memories: waveform A, B, C, and D.

**Source** CH1, CH2, Math waveform

**Panel operations** 1. Make sure the waveform you want to save (CH1, CH2, or Math result) appears in the display. For Math operations details, see page39.

2. Press the MENU key and select the WAVE SAVE menu using the Up/Down keys.

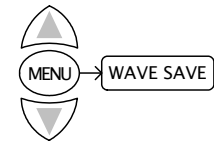

3. Press F1 (Source) repeatedly and select the waveform source.

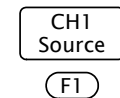

4. Press F2 (WAVE) repeatedly and select the memory location from A to D.

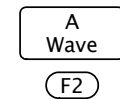

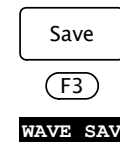

5. Press F3 (Save) to confirm saving the waveform into the specified memory location. Make sure that the message "WAVE SAVED" appears in the display.

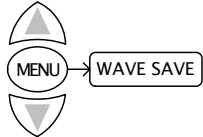
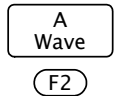

### Recalling waveforms

|          |  |
|----------|--|
| Overview | Up to four waveforms can be stored in and recalled from the GDS-122 internal memory. The stored waveform can be used for reference, comparison, or analysis. |
| Memory   | Four memories: waveform A, B, C, and D.  |
| Source   | CH1, CH2, Math waveform  |

- Panel operations
1. Press the MENU key and select the WAVE SAVE menu using the Up/Down keys.
 
  2. Press F2 (Wave) repeatedly and select the waveform you want to recall.
 
  3. Press F4 to turn on the waveform. The waveform appears in the display.
 

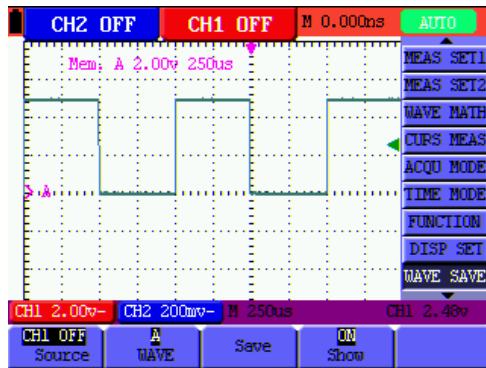

**Note** The recalled waveform maintains its original horizontal scale and vertical scale, which are shown in the top left corner of the display. Changing the current scale does not affect the recalled waveform's shape.

### Menu Tree / Operation Shortcuts

Accessing menus The following menu trees are accessible by pressing the MENU key followed by Up/Down keys, except for the OSC OPTION key (page60).



#### Trigger

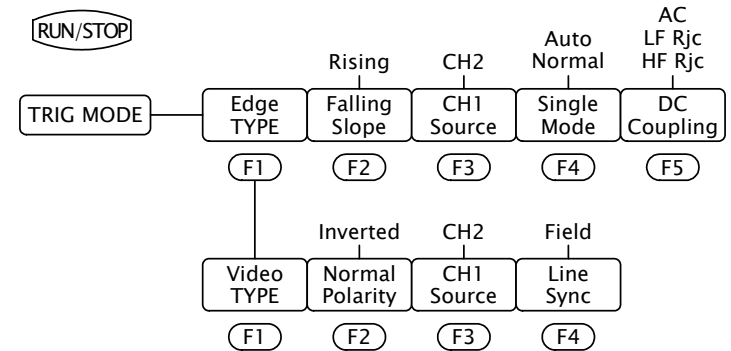

|                              |                                    |
|------------------------------|------------------------------------|
| Select run or stop mode      | RUN/STOP key                       |
| Select edge or video trigger | TRIG MODE→F1 (TYPE)                |
| Select trigger slope         | TRIG MODE→F1 (edge)→F2 (Slope)     |
| Select trigger source        | TRIG MODE→F1→F3 (Source)           |
| Select trigger mode          | TRIG MODE→F1 (edge)→F4 (Mode)      |
| Select trigger coupling      | TRIG MODE→F1 (edge)→F5 (Coupling)  |
| Select video polarity        | TRIG MODE→F1 (video)→F2 (Polarity) |
| Select video line sync       | TRIG MODE→F1 (video)→F4 (Sync)     |

#### CH1 /CH2 Setup

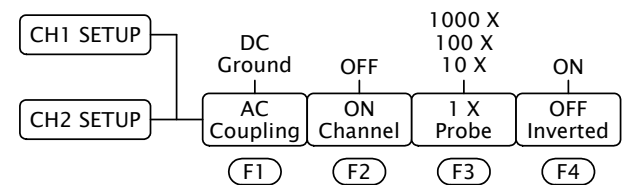

|                                   |                            |
|-----------------------------------|----------------------------|
| Select AC, DC, or Ground coupling | CH1 /2 SETUP→F1 (Coupling) |
|-----------------------------------|----------------------------|

|                          |                           |
|--------------------------|---------------------------|
| Turn CH1 on or off       | CH1 /2 SETUP→F2(Channel)  |
| Select probe scaling     | CH1 /2 SETUP→F3(Probe)    |
| Turn inversion on or off | CH1 /2 SETUP→F4(Inverted) |

### Measurement Setup 1 /2

|                                    |                          |
|------------------------------------|--------------------------|
| Measure CH1 /CH2 frequency         | MEAS SET1 /2→F1(Freq)    |
| Measure CH1 /CH2 period            | MEAS SET1 /2→F2(Period)  |
| Measure CH1 /CH2 mean value        | MEAS SET1 /2→F3(Mean)    |
| Measure CH1 /CH2 peak to peak time | MEAS SET1 /2→F4(PK-PK)   |
| Measure CH1 /CH2 cycle             | MEAS SET1 /2→F5(Cyc RMS) |

### Wave Math

|                       |                       |
|-----------------------|-----------------------|
| Subtract CH2 from CH1 | WAVE MATH→F1(CH1-CH2) |
| Subtract CH1 from CH2 | WAVE MATH→F2(CH2-CH1) |
| Add CH2 to CH1        | WAVE MATH→F3(CH1+CH2) |
| Multiply CH2 with CH1 | WAVE MATH→F4(CH1*CH2) |
| Divide CH1 by CH2     | WAVE MATH→F5(CH1/CH2) |

### Cursor Measurement

|                             |                      |
|-----------------------------|----------------------|
| Activate cursor measurement | CURS MEAS→F1(Type)   |
| Select source channel       | CURS MEAS→F2(Source) |

### Acquisition Mode

|                         |                           |
|-------------------------|---------------------------|
| Select sampling mode    | ACQU MODE→F1(Sample)      |
| Select peak detect mode | ACQU MODE→F2(Peak Detect) |
| Select average mode     | ACQU MODE→F3(Average)     |
| Select average number   | ACQU MODE→F3→F4(Averages) |

### Time Mode

|                       |                             |
|-----------------------|-----------------------------|
| Select main timebase  | TIME MODE→F1(Main TimeBase) |
| Set window zoom width | TIME MODE→F2(Zone Window)   |
| Zoom window           | TIME MODE→F3(Window)        |

### Function

|                         |                              |
|-------------------------|------------------------------|
| Recall factory settings | FUNCTION→F1(Recall Factory)  |
| Run self calibration    | FUNCTION→F2(Autocalibration) |

### Display

|          |                   |                  |                |                   |
|----------|-------------------|------------------|----------------|-------------------|
| DISP SET | Vectors Type (F1) | OFF Persist (F2) | YT Format (F3) | Bitmap Carry (F4) |
|----------|-------------------|------------------|----------------|-------------------|

|                            |                       |
|----------------------------|-----------------------|
| Select line display        | DISP SET→F1 (Type)    |
| Select persistency         | DISP SET→F2 (Persist) |
| Select display format      | DISP SET→F3 (Format)  |
| Select display save format | DISP SET→F4 (Carry)   |

**Wave Save**

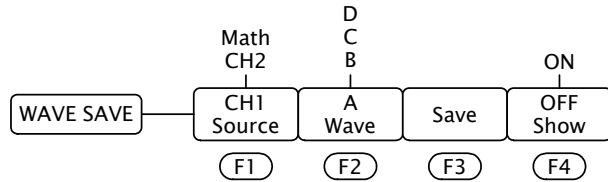

|                                 |                       |
|---------------------------------|-----------------------|
| Select source channel           | WAVE SAVE→F1 (Source) |
| Select waveform ID              | WAVE SAVE→F2 (Wave)   |
| Save waveform                   | WAVE SAVE→F3 (Save)   |
| Turn waveform display on or off | WAVE SAVE→F4 (Show)   |

**System Status**

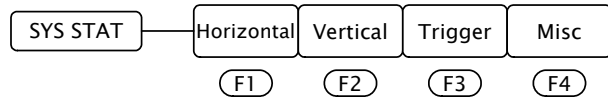

|                          |                          |
|--------------------------|--------------------------|
| Show horizontal settings | SYS STAT→F1 (Horizontal) |
| Show vertical settings   | SYS STAT→F2 (Vertical)   |
| Show trigger settings    | SYS STAT→F3 (Trigger)    |
| Show serial number       | SYS STAT→F4 (Misc)       |

**OSC OPTION key**

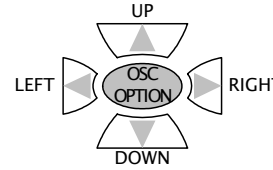

Press the OSC OPTION key repeatedly. The menu message appears in the lower half of the display and the functionalities of four keys, UP, DOWN, RIGHT, LEFT, change accordingly.

LEFT/RIGHT - Time Base  
UP/DOWN - CH1 Vol

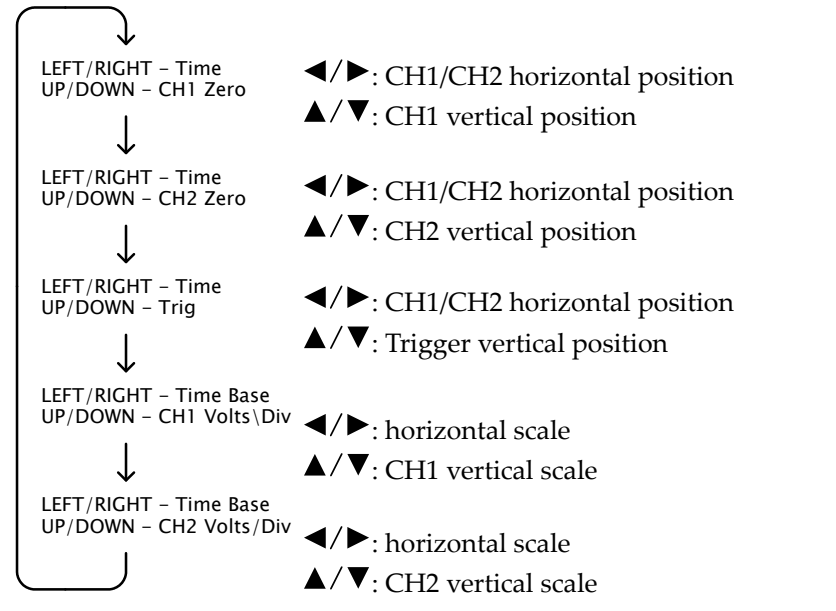

|                        |                               |
|------------------------|-------------------------------|
| (Math mode)            | (Math mode)                   |
| ◀/▶ - Time             | ◀/▶: Math horizontal position |
| ▲/▼ - CHMath Volts/Div | ▲/▼: Math vertical position   |

|                  |                                   |
|------------------|-----------------------------------|
| (Cursor mode)    | (Cursor mode)                     |
| ◀/▶ - Time       | ◀/▶: CH1/CH2 horizontal position  |
| ▲/▼ - Cursor 1/2 | ▲/▼: Cursor 1/2 vertical position |

## Using the Software

**Overview** The GDS-122 PC software, included in the CD-ROM, allows you to view the waveforms in your familiar PC environment – large display and mouse operation. Multiple cursors provide flexible waveform measurements.

**Software functionalities** The PC software can run the following measurement and actions.

- Viewing real-time updated waveforms
- Running up to 6 cursor measurements
- Measuring period/frequency/pk-pk voltage
- Printing out waveform images
- Saving and recalling waveform shape and data

**Software operations** The following is the list of software operations described in this chapter.

- |   |        |
|---|--------|
| • Installing the software                               | page62 |
| • Modifying, reinstalling, or uninstalling the software | page64 |
| • Connecting the GDS-122                                | page65 |
| • Configuring the screen                                | page68 |
| • Viewing waveforms                                     | page69 |
| • Measuring waveforms                                   | page75 |
| • Saving waveforms                                      | page75 |
| • Recalling waveforms                                   | page77 |
| • Printing out waveforms                                | page80 |
| • Accessing the Help                                    | page82 |

**Note** The PC software is intended for oscilloscope operations only; it does not include multimeter operations.

## Installing the software

- PC requirements**
- Windows 2000 or XP
  - 20MB hard drive space
  - USB host port x 1

**Installation steps** 1. Activate the Setup.exe file in the CD-ROM.



2. The software starts preparing the installation. When the welcome window is displayed, click *Next* and start installing the software to your PC.



3. The customer information window will appear. Enter the user name and organization name. Select which user will hold the right to access the software and click *Next*.

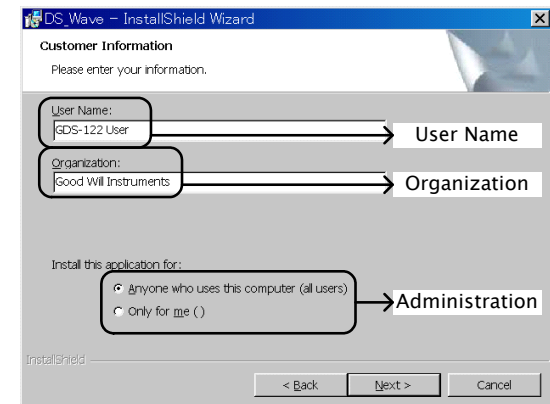

4. Change the installation directory if necessary and click *Next*.

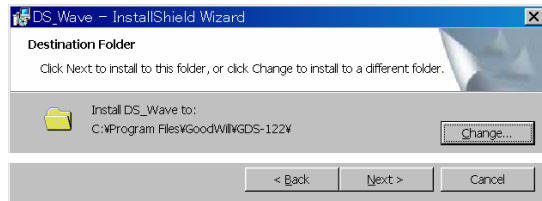

5. Click *Install* to start installing the software.

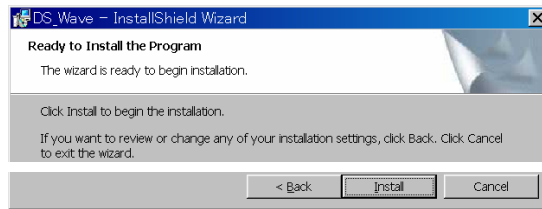

6. The software installation automatically starts and ends. Click *Finish* to complete installation.

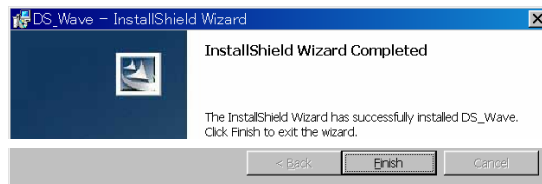

Installing the software is completed

## Modifying/Reinstalling/Uninstalling the software

### Overview

After installing the software, you can do the followings using the same setup file.

- Modifying the software components
- Repairing the software
- Uninstalling the software

### Steps

1. Activate the Setup.exe. Follow the same procedures as installing the software until the *Program Maintenance* window appears.

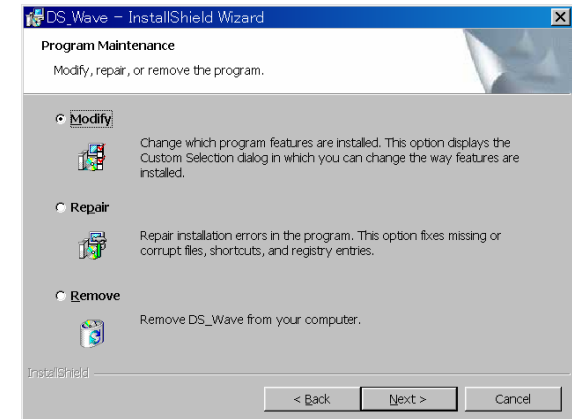

2. Select the action – *Modify* the software components, *Repair* the software, or *Remove* (uninstall) the software – and click *Next*. Proceed according to the instructions.

### Shortcut for uninstall

Alternatively, you can select the Uninstall DC\_Wave from the program startup menu to uninstall the software.

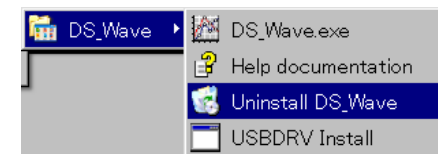



**Activating the software and connecting the GDS-122**

- Overview**      Activate the software and connect the GDS-122 to it properly by going through these steps, described in the paragraphs that follow.
1. Activating the software and configuring the communication port
  2. Activating the GDS-122 and configuring the data format
  3. Connecting them together and if necessary, installing the USB driver
  4. Acquiring waveform data to confirm that the communication is being secured

**Activating the software**

1. Open the software by selecting DS\_Wave.exe from the startup menu.

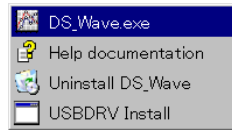

2. Select Communications – Ports Settings from the menu or click the Ports-settings icon on the Toolbar.

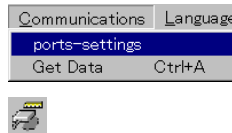

Make sure that USB connection is being selected. The baud rate, stop bit, data bit, and parity settings are fixed.

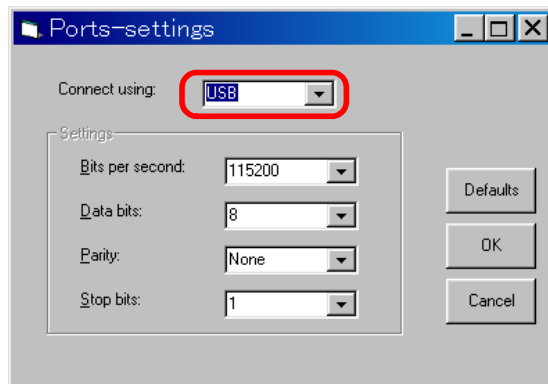

**Activating the GDS-122**

1. Power up the GDS-122 and activate the oscilloscope screen.
2. Connect an input signal to CH1 and make sure that the waveform is shown appropriately on the GDS-122 display.
3. Open the DISP SET menu and press F4 (Carry) to select the format of the waveform data sent from the GDS-122 to the software.

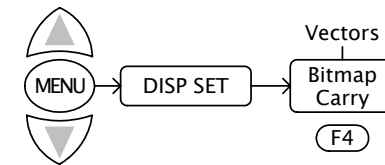

**Vectors**      Vectored data of the waveform. Always select the vector format when viewing the waveform in the software.

**Bitmap**      Bitmap image of the display. Select the Bitmap format only when taking the bitmap snapshot of the GDS-122 hardware screen.

**Connecting the cable**

1. Connect the GDS-122 to the PC (software) via the USB cable.
2. Make sure that the USB driver is installed in your PC by accessing the Device Manager (Control Panel -> System -> Hardware tab). The GDS-122 should be recognized as a USB hub.

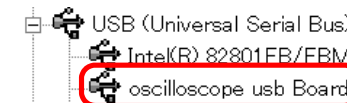

3. If the driver has not been recognized, install it manually by selecting USBDRV Install from the startup menu.



The driver file is located in the USBDRV folder in the software directory.

Acquiring data

In the software, select **Communications – Get Data** from the menu. Alternatively, you may click the Get data icon, or press the Ctrl + A key.

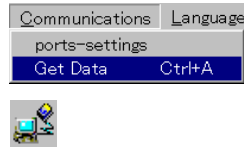

**Acquiring the GDS-122 display snapshot**

When the “Bitmap” format is selected in the GDS-122 display carry setting, the software acquires the display snapshot (\*.bmp) at the moment. Save the file in the local folder and use a graphic software to open and edit it.

**Acquiring the GDS-122 waveform**

When the “Vectors” format is selected in the GDS-122 display carry setting, the software acquires the waveform data (\*.bin) at the moment.

1. The waveform data will be stored in the PC memory to allow to be recalled later (page79). Edit the location and click Start.

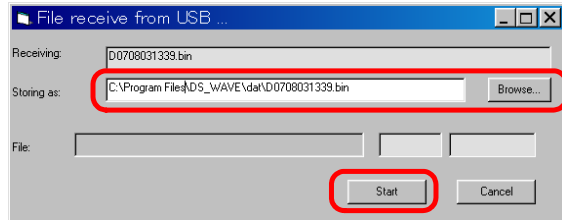

2. The waveform appears in the software screen.

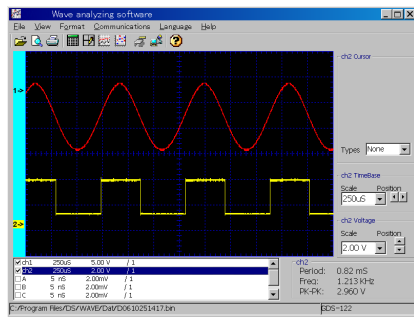

Connecting the GDS-122 to the software is completed

**Configuring the screen**

Overview

This section introduces how to configure the following parameters in the software screen (waveform viewing mode) to optimize the user interface.

- Background color
- Grid color
- Grid on/off
- Drawing format
- Language
- Closing the software

Screen overview

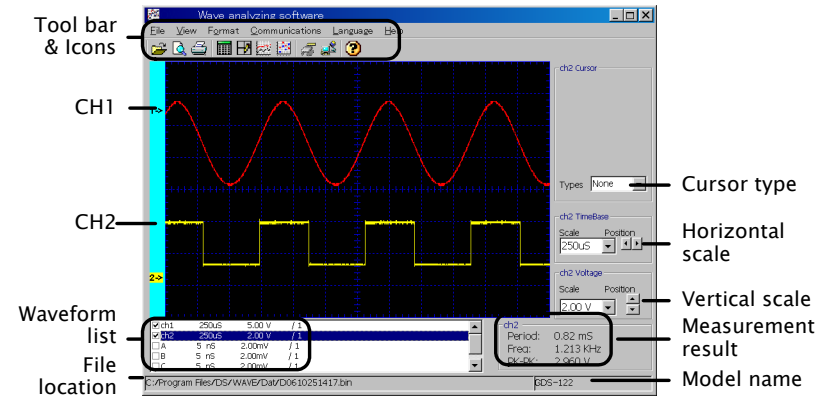

Changing the background color

To change the background color, select **View > Background Color** from the menu and select the new color from the color palette that appears. Alternatively, you can also double click inside the screen to call the color palette.

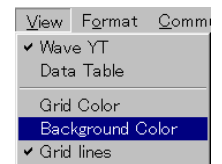

Black background

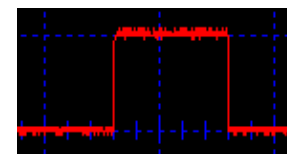

White background

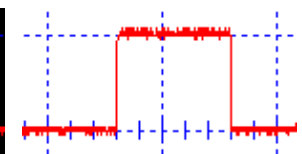

Turning the grid on or off

To turn on or off the grid, select View > Grid lines from the menu or click the Gridlines icon.

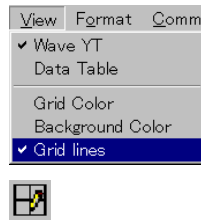

Grid on

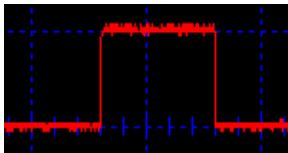

Grid off

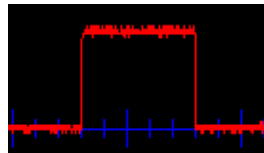

Changing the grid color

Make sure the grid is already turned on. Select View > Grid Color from the menu and select the new color from the color palette that appears.

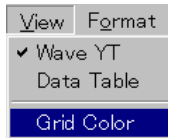

Blue grid

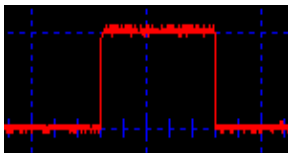

White grid

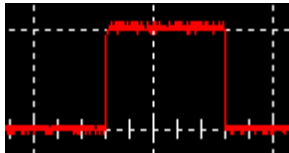

Changing the waveform drawing format

You can select how the waveform is being drawn from two formats, line and dots. Select Format > Data Line (Point) from the menu or click the icons.

Line

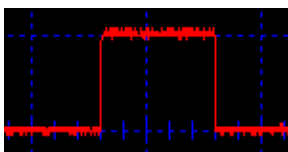
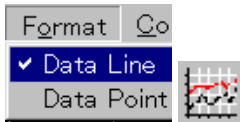

Point

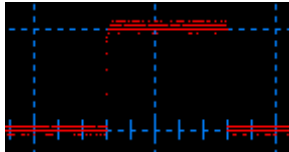
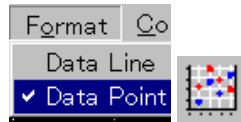

Changing the language

You can select the language from English (default) or Simplified Chinese. Select Language > English (Chinese) from the menu. The Language menu itself always stays as English.



Closing the software

You can close the software in one of the following ways. The screen configurations will be retained the next time you open the software.

- Pressing the Alt + F4 keys
- Selecting File > Exit from the menu

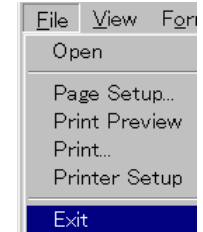

- Clicking the Close icon at the top right corner of the software



## Viewing the waveforms

- Overview** This section introduces how to modify the waveform settings for better viewings.
- Selecting the displayed waveforms
  - Refreshing the waveforms
  - Selecting the active waveform
  - Changing the waveform positions
  - Changing the waveform scales
  - Viewing the automatic measurement results

### Screen overview

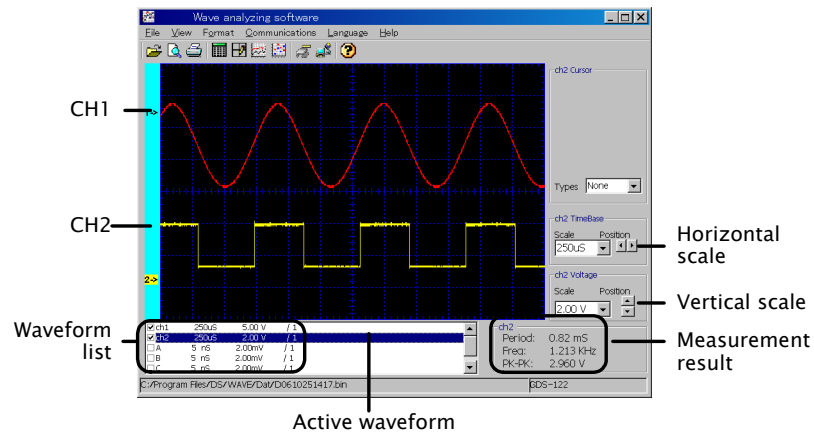

**Selecting the displayed waveforms** In the left bottom corner of the screen, put a checkmark in the waveform that needs to appear. Maximum six waveforms are available: CH1, CH2, A, B, C, D. Waveforms A to D have to be stored in the GDS-122 hardware beforehand (see page 54 for details).

(CH1, CH2 selected)

|                                     |     |       |        |     |
|-------------------------------------|-----|-------|--------|-----|
| <input checked="" type="checkbox"/> | ch1 | 250uS | 5.00 V | / 1 |
| <input checked="" type="checkbox"/> | ch2 | 250uS | 2.00 V | / 1 |
| <input type="checkbox"/>            | A   | 5 nS  | 2.00mV | / 1 |
| <input type="checkbox"/>            | B   | 5 nS  | 2.00mV | / 1 |
| <input type="checkbox"/>            | C   | 5 nS  | 2.00mV | / 1 |

**Refreshing the waveforms** In the software, select **Communications – Get Data** from the menu. Alternatively, you may click the Get data icon, or press the shortcut keys, Ctrl + A.



**Selecting the active waveform** Waveform scale settings and automatic measurements are done on the active waveform.

1. Click on the waveform name in the bottom left corner of the screen.

(CH1 selected as the active waveform)

|                                     |     |       |        |     |
|-------------------------------------|-----|-------|--------|-----|
| <input checked="" type="checkbox"/> | ch1 | 250uS | 5.00 V | / 1 |
| <input checked="" type="checkbox"/> | ch2 | 250uS | 2.00 V | / 1 |
| <input type="checkbox"/>            | A   | 5 nS  | 2.00mV | / 1 |
| <input type="checkbox"/>            | B   | 5 nS  | 2.00mV | / 1 |
| <input type="checkbox"/>            | C   | 5 nS  | 2.00mV | / 1 |

2. The following locations changes into the selected channel (example: CH1).

- Colored channel label (at the left side of the screen)
- Cursor, Time base, Voltage settings (at the right side of the screen)   

|     |          |
|-----|----------|
| ch1 | Cursor   |
| ch1 | TimeBase |
| ch1 | Voltage  |
- Automatic measurement results (at the bottom right corner of the display)   

|     |                 |
|-----|-----------------|
| ch1 | Period: 0.82 mS |
|     | Freq: 1.213 KHz |
|     | PK-PK: 13.200 V |

**Changing the waveform positions**

### Changing the horizontal position

1. Move the mouse over the waveform until the mouse icon changes into a left-right arrow.

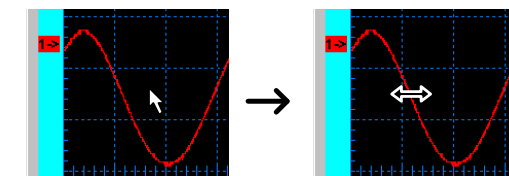

- Hold the mouse and drag the waveform sideways.

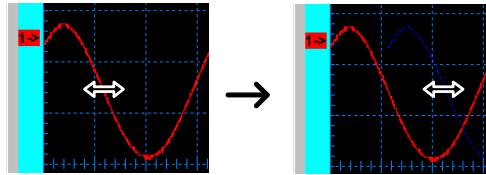

**Changing the vertical position**

Click the channel label at the left side of the waveform and drag the waveform up or down.

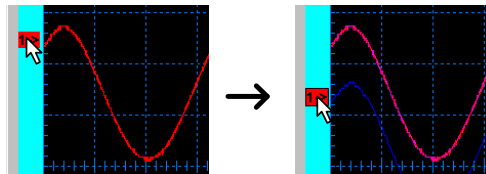

**Changing the waveform scales**

Before changing the scales, make sure that the correct waveform is selected (highlighted) in the lower left corner of the screen (example: CH1).



**Changing the horizontal scale**

Select the horizontal scale using the list at the right side of the screen. You can select the scale either by searching in the Scale column or by clicking the Position arrows.

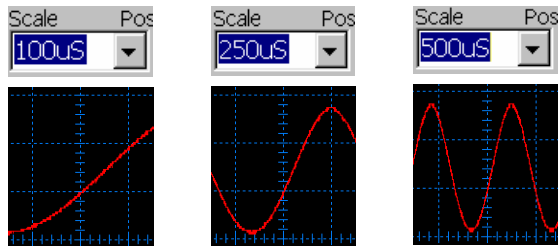
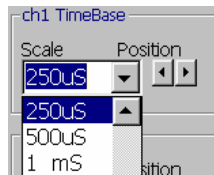

**Changing the vertical scale**

Select the vertical scale using the list at the right side of the screen. You can select the scale either by searching in the Scale column or by clicking the Position arrows.

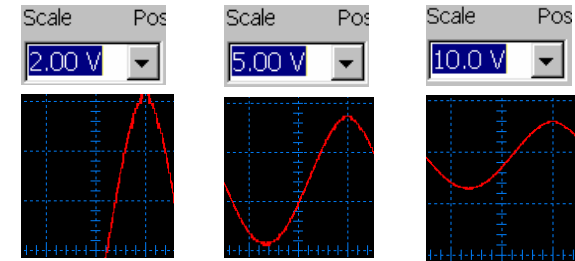
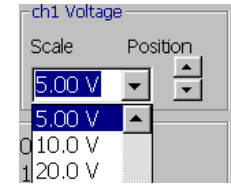

**Viewing the automatic measurement results**

Before viewing the measurement results, make sure that the correct waveform is selected (highlighted) in the lower left corner of the screen (example: CH1).

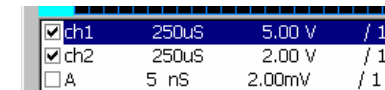

The measurement result is updated in the lower right corner of the screen. Three parameters are listed.

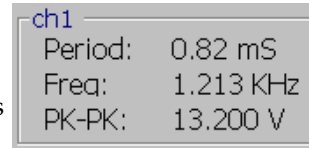

- Period: measures the waveform period in ms.
- Freq: measures the waveform frequency in kHz.
- PK-PK: measures the peak to peak voltage in V.

## Using the cursor measurements

### Overview

This section introduces how to use cursor measurements in the software screen.

- Activating the cursors
- Viewing the cursor measurement results
- Moving the cursors

### Screen overview

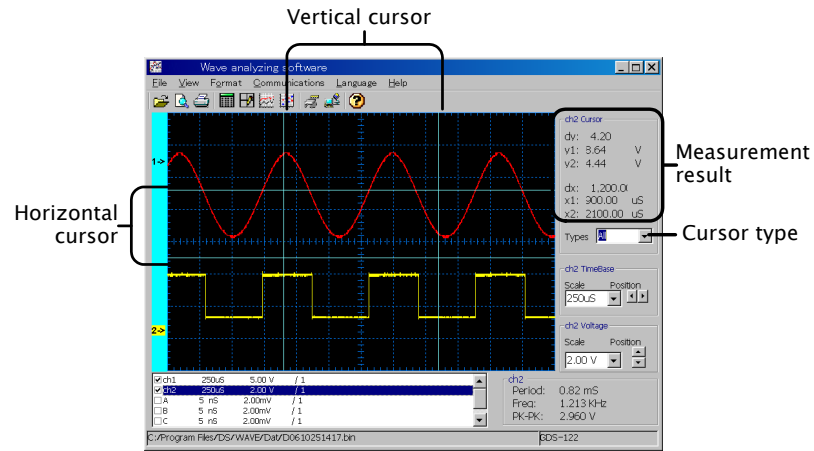

### Activating the cursors

Before activating the cursors, make sure that the correct waveform is selected (highlighted) in the lower left corner of the screen (example: CH1).

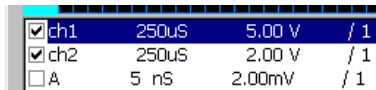

Select the cursors from the list in the right side of the screen.

- None: the cursor is turned off. Types
- Horizontal: the horizontal cursors appear. Types
- Vertical: the vertical cursors appear. Types

- All: both the horizontal and vertical cursors appear. Types

### Viewing the cursor measurement results

The cursor measurement results are updated in the right side of the screen.

- dy: the voltage difference between y1 and y2 cursors
- y1, y2: voltage cursors 1 and 2
- dx: the time difference between x1 and x2 cursors
- x1, x2: time cursors 1 and 2

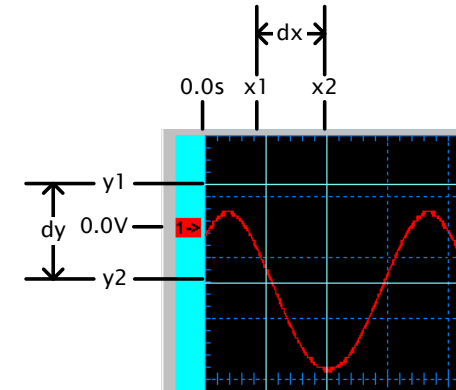
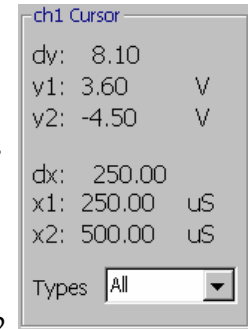

### Moving the cursors

Move the mouse over the cursor until the mouse icon changes into a left-right arrow. Hold the mouse and drag the cursor sideways (horizontal cursor) or vertically (vertical cursor).

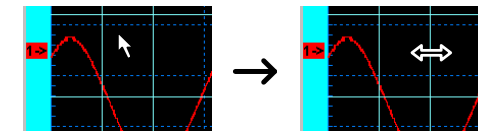

The cursor measurement result changes accordingly.

**Saving waveforms**

**Overview**

You can save the waveforms into the PC in two ways. For details of recalling them, see page79.

- Storing waveform data (\*.bin file, for viewing in the software)
- Storing data points (\*.txt file, for data analysis such as in graphs and maps)

For details of storing waveforms into the GDS-122 hardware, see page54.

**Storing waveform data**

When retrieving waveform data from the GDS-122, the waveform data (\*.bin format) is automatically stored. For details, see page69.

**Storing data point**

1. Make sure that the waveform is being displayed in the screen. To recall waveforms that are stored in the PC, see page79.

2. Select **View > Data Table** from the menu, or click the Data Table icon on the Toolbar. The Data Table dialogue appears.

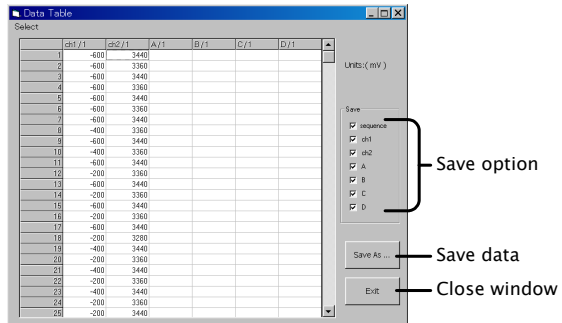
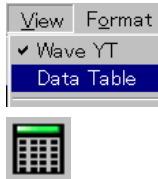

3. Select the data to be saved from the Save column.

- sequence: the identification number for each data point
- ch1/ch2: CH1 and CH2 waveform data
- A/B/C/D: the waveforms stored in the GDS-122 hardware memory

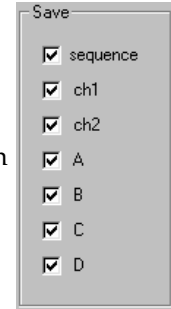

Data points stored in an Excel sheet (example)

|   | A           | B       | C     | D     | E     | F     | G |
|---|-------------|---------|-------|-------|-------|-------|---|
| 1 | Units: (mV) |         |       |       |       |       |   |
| 2 | ch1 / 1     | ch2 / 1 | A / 1 | B / 1 | C / 1 | D / 1 |   |
| 3 | 1           | -600    | 3440  |       |       |       |   |
| 4 | 2           | -600    | 3360  |       |       |       |   |
| 5 | 3           | -600    | 3440  |       |       |       |   |
| 6 | 4           | -600    | 3360  |       |       |       |   |

4. Click the Save As... button to save the data into a directory. The standard Save dialog appears.

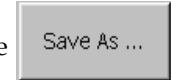

5. To close the Data Point dialogue, do one of the following actions.

- Press the Ctrl + Alt key
- Click the Exit icon

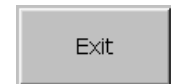

- Click the Close icon at the top right corner of the dialogue



**Recalling waveforms**

**Overview** You can recall the waveforms from the PC in two ways. For details of saving them, see page77.

- Recalling waveform data (\*.bin file, for viewing in the software)
- Recalling data points (\*.txt file, for data analysis such as in graphs and maps)

For details of recalling waveforms into the GDS-122 hardware, see page55.

- Recalling the waveform data**
1. Select **File > Open** from the menu or press the shortcut key, **Ctrl + O**.
  2. The File Open dialogue opens. Select one of the SPB bin file (\*.bin) and click OK.
  3. The waveform(s) will be recalled in the screen.

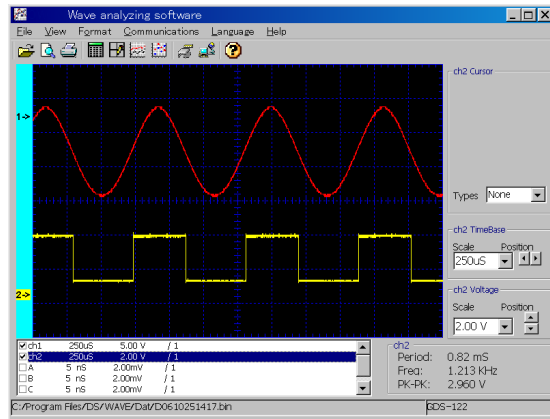

- Recalling the data points**
1. For recalling the data points, you need to open a text editor or a spreadsheet program like Excel, in which you can organize the data and create graphs and maps for advanced analysis.
  2. Open the saved \*.txt file from the application.

**Printing out waveforms**

**Overview** You can print out the screen contents to a printer connected to the PC. When you are printing the waveform for the first time, follow all the steps in the following order.

1. Setting up the printer
2. Setting up the page format
3. Printing out

- Setting up the printer**
1. Select **File > Printer Setup** from the menu. The standard printer setting dialogue opens.
  2. Select the printer and its properties, paper size, and orientation.

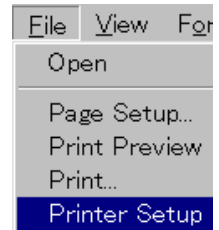

- Setting up the page format**
1. Select **File > Page Setup** from the menu. The Page Setup dialog window opens.

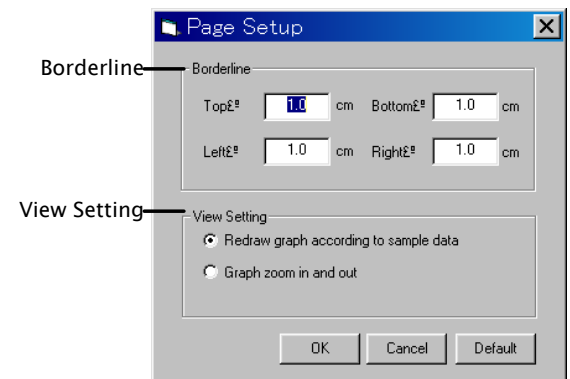
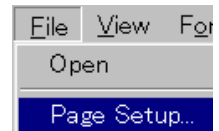

2. Set the borderlines (print margins). The range is 0 to 10.0cm each.



3. Select the View Setting.

**Redraw graph according to sample data:**

The GDS-122 refreshes the waveform and adjust its scale before printing. The most recent data can be taken, but might take time for refreshing.

**Graph zoom in and out**

The existing waveform is used with its scale adjusted. Since retrieving the data is not involved, fast printing is ensured.

4. Open the print preview by selecting File > Print Preview from the menu or clicking the Print Preview icon on the toolbar. Make sure that the waveforms are placed appropriately.

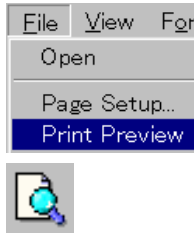

**Printing out** Print out the waveform in one of the following ways.

- Selecting File > Print in the Print Preview screen menu



- Selecting File > Print from the software menu

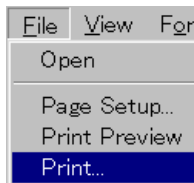

- Pressing the shortcut keys, Ctrl + P

- Clicking the Printer icon on the Toolbar



**Accessing the Help**

**Overview** The Help file describes how to install and use the software. The About screen shows the software version.

**Opening the Help** Open the Help in separate file using one of the following methods.

- Selecting Help > Help from the menu
- Clicking the Help icon on the Toolbar
- Pressing the shortcut key, F1
- Selecting the Help documentation from the startup menu

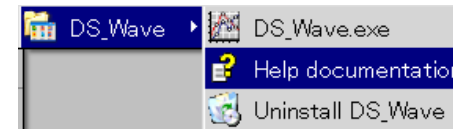
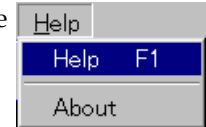

**Software version** To view the software version, select Help > About from the menu. The software version screen appears.

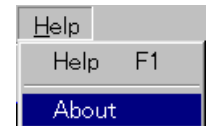

# USING THE MULTIMETER







This chapter describes the multimeter functionalities in the GDS-122. Functionalities includes three major items (Voltage, Current, Impedance) and three additional items (Diode, Continuity, Capacitance). The current measurement and capacitance measurement use extension modules to deal with large current and small capacitance, respectively. Delta measurement and automatic range switching features offer flexibility and convenience.

---

|                                 |    |
|---------------------------------|----|
| Activating the Multimeter ..... | 84 |
| Measuring Voltage .....         | 85 |
| Measuring Current .....         | 87 |
| Measuring Impedance .....       | 89 |
| Measuring Diode .....           | 91 |
| Measuring Continuity .....      | 92 |
| Measuring Capacitance .....     | 93 |

## Activating the Multimeter

---

- Panel operations
1. Press the power switch. The welcome screen with the corporate logo appears on the display. 
  2. To adjust display brightness, use the switch on the side: up (bright) or down (dark). 
  3. Press any key (example: MENU (Example) key) to activate the display. The battery icon at the top left corner of the display shows the battery level.   
 > 75%    75%    50%    25%    < 25%  

  4. Press A (current), V (voltage), or R (impedance, diode, continuity, capacitance) switch to proceed. A warning message might appear to remind you of correct connections.   
  





5. Press any key to cancel the warning message and resume the measurement.

## Measuring Voltage

|   |           |                  |
|---|-----------|------------------|
| DC voltage specifications (details: page98) | Range     | 400mV, 4V, 400V  |
|   | Accuracy  | ±(1% + 1 digit)  |
|   | Max input | 400V             |
| AC voltage specifications (details: page98) | Range     | 4V, 40V, 400V    |
|   | Accuracy  | ±(1% + 3 digits) |
|   | Max input | 400V             |
|   | Frequency | 40Hz to 400Hz    |

Panel operations 1. Press the V switch to select the Voltage measurement. If a warning message appears, press any key to resume measurement.



2. The voltage measurement screen appears.

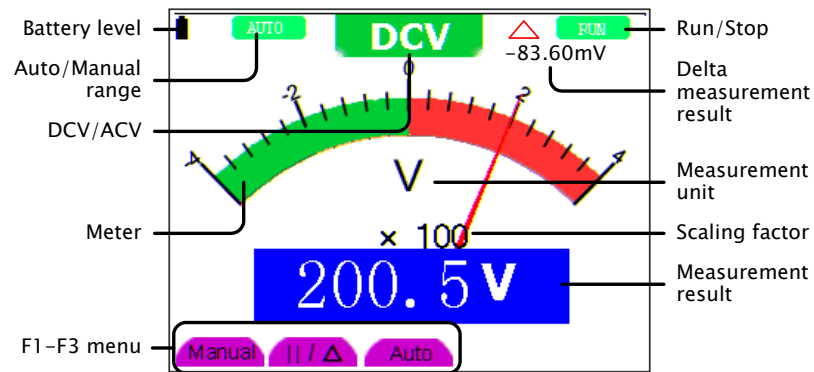

3. Press the AUTOSET key repeatedly to select DC or AC voltage measurement.



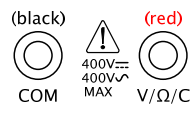

4. Connect the test leads to the terminals:  
COM for the black lead  
V/Ω/C for the red lead





5. The measurement result will be constantly updated in the display. For more detailed settings, see the following instructions.



Auto ranging To let the GDS-122 select the voltage range automatically, press F3 (Auto). The indicator at the top left corner of the display changes to AUTO.



Manual ranging To select the voltage range manually, press F1 (Manual). The indicator at the top left corner of the display changes to MANUAL.

Freezing the measurement To freeze the measurement, press the RUN/STOP key. The measurement result will be retained and the indicator at the top right corner of the display changes to STOP. To unfreeze, press the RUN/STOP key again.

Measuring delta voltage To measure the delta value, press F2 (II/Δ). The measurement result at the moment moves to the top right corner of the display, and the measurement result becomes the difference between the original result.

## Measuring Current

|   |                  |  |
|---|------------------|--|
| DC current specifications (details: page98) | Range & Accuracy | 40mA ±(1% + 1 digit)<br>400mA ±(1.5% + 1 digit)<br>20A ±(3% + 3 digits)  |
|   | Max input        | 400mA (direct input)<br>20A (via the extension module)                   |
| AC current specifications (details: page98) | Range & Accuracy | 40mA ±(1.5% + 3 digits)<br>400mA ±(2% + 1 digit)<br>20A ±(5% + 3 digits) |
|   | Max input        | 400mA (direct input)<br>20A (via the extension module)                   |

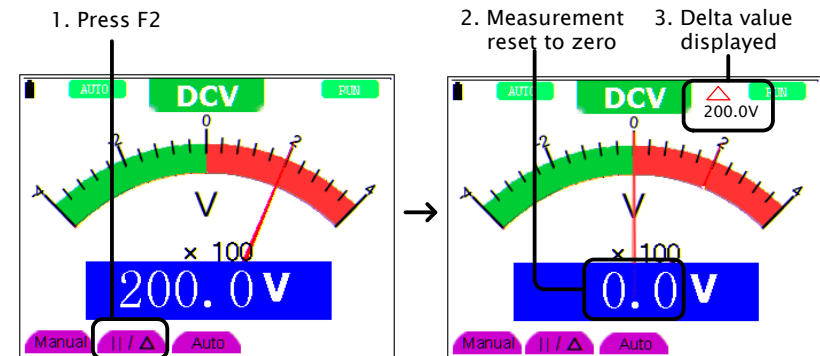
Panel operations 1. Press the A switch to select the current (Ampere) measurement. If a warning message appears, press any key to resume measurement.

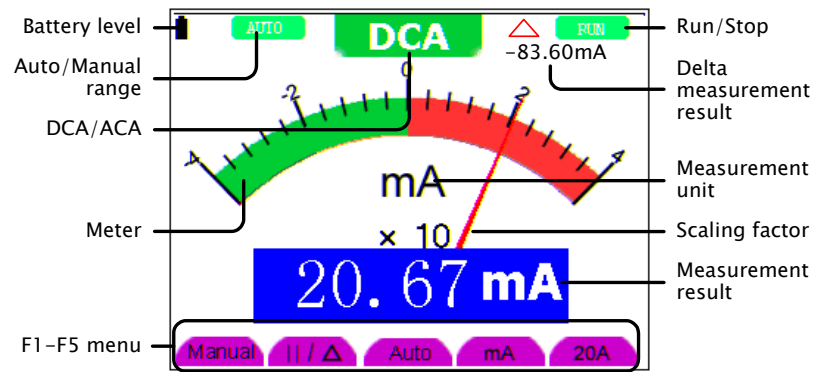

2. Press the AUTOSET key repeatedly to select DC or AC current measurement.

Measuring 0mA to 400mA 1. Connect the test leads to the terminals: COM for the black lead mA/A for the red lead

If the range is set at 20A, press F4 (mA) and change it to mA range.

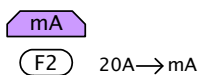
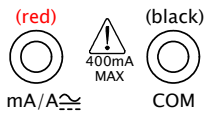

2. Select automatic range by pressing F3 (Auto) or manual by F1 (Manual). The indicator at the top left corner of the display changes accordingly.

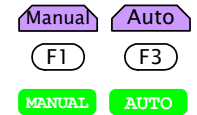

Measuring 400mA to 20A ⚠

1. Connect the Current Extension module to the COM & mA/A terminals. Then, connect the test leads to the extension module.

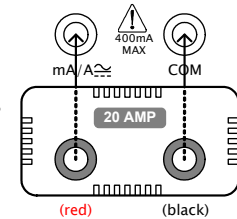

2. Press F5 (20A) and select the 20A range. The MANUAL range indicator activates. (Auto range is not available)

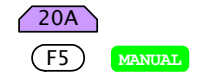

Freezing the measurement

To freeze the measurement, press the RUN/STOP key. The measurement result will be retained and the indicator at the top right corner of the display changes to STOP. To unfreeze, press the RUN/STOP key again.

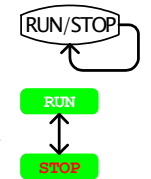

Measuring delta current

To measure the delta value, press F2 (II/Δ). The measurement result at the moment moves to the top right corner of the display, and the measurement result becomes the difference between the original result.

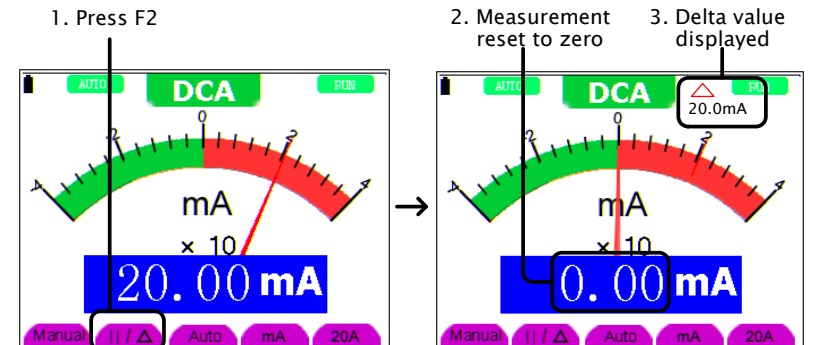





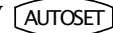

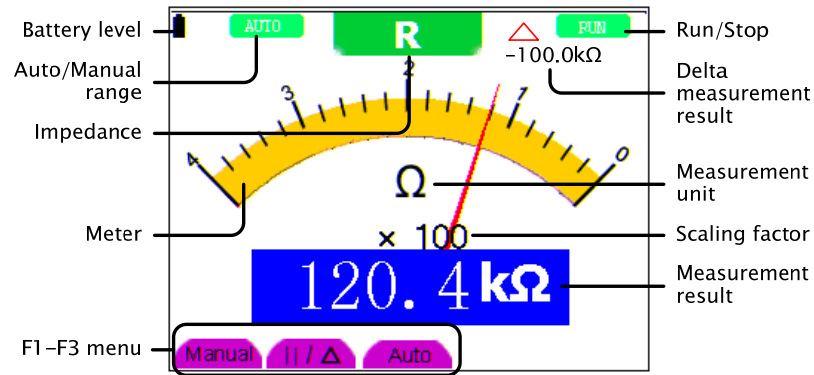
## Measuring Impedance



|  |                    |  |
|--|--------------------|--|
| Impedance specifications (details: page98) | Range & Resolution | 400Ω ±(1% + 3 digits)<br>4k, 40k, 400k, 4MΩ ±(1% + 1 digit)<br>40MΩ ±(1.5% + 3 digits) |
|--|--------------------|--|



- Panel operations
1. Press the R switch. If a warning message appears, press any key to resume measurement. 
  2. Press the AUTOSET key repeatedly to select the impedance measurement. 
  3. The impedance screen appears.





4. Connect the test leads to the terminals:  
COM for the black lead  (black)  
V/Ω/C for the red lead  (red)  

5. The measurement result will be constantly updated in the display. For more detailed settings, see the following instructions.

**Auto ranging** To let the GDS-122 select the voltage range automatically, press F3 (Auto). The indicator at the top left corner of the display changes to AUTO.   
  

**Manual ranging** To select the voltage range manually, press F1 (Manual). The indicator at the top left corner of the display changes to MANUAL.   
  



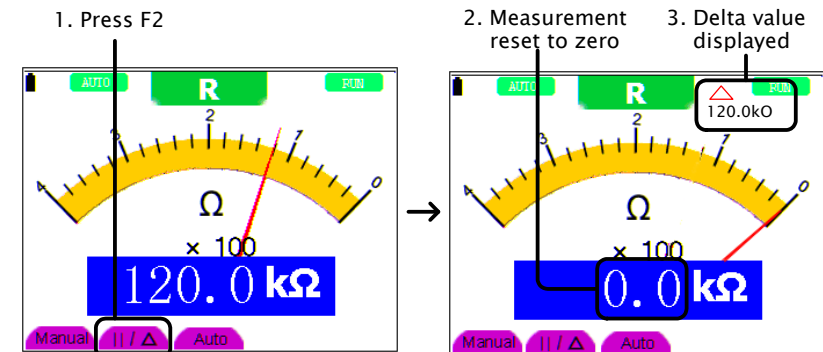

**Freezing the measurement** To freeze the measurement, press the RUN/STOP key. The measurement result will be retained and the indicator at the top right corner of the display changes to STOP. To unfreeze, press the RUN/STOP key again.   
  

**Measuring delta impedance** To measure the delta value, press F2 (II/Δ). The measurement result at the moment moves to the top right corner of the display, and the measurement result becomes the difference between the original result.   





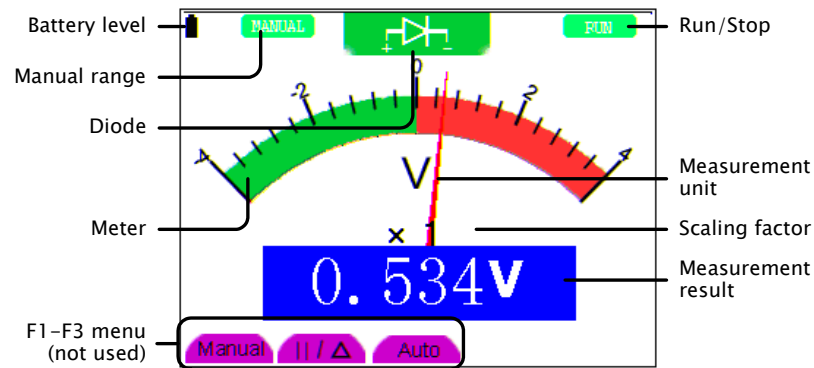

## Measuring Diode

Range 0V to 1.5V

- Panel operations
1. Press the R switch. If a warning message appears, press any key to resume measurement.  
  2. Press the AUTOSET key repeatedly to select the diode measurement. 
  3. The diode measurement screen appears.



4. Connect the test leads to the terminals:  
COM for the black lead     
V/Ω/C for the red lead
5. The measurement result will be constantly updated in the display.



Freezing the measurement

To freeze the measurement, press the RUN/STOP key. The measurement result will be retained and the indicator at the top right corner of the display changes to STOP. To unfreeze, press the RUN/STOP key again.





## Measuring Continuity

Conditions < 50Ω (beeping)

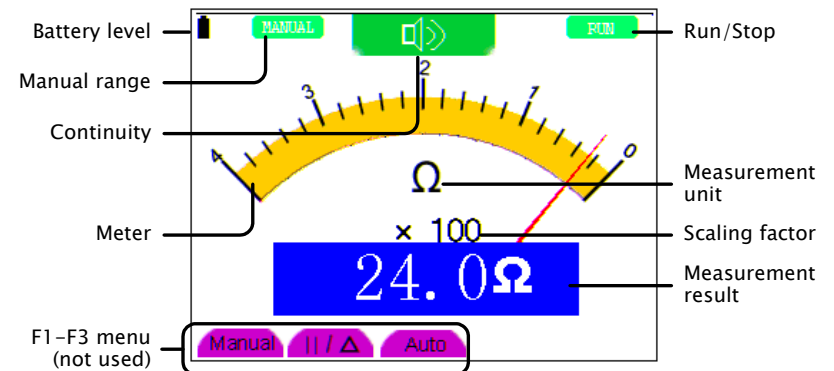
- Panel operations
1. Press the R switch. If a warning message appears, press any key to resume measurement.  
  2. Press the AUTOSET key repeatedly to select the continuity measurement. 
  3. The continuity measurement screen appears.



4. Connect the test leads to the terminals:  
COM for the black lead     
V/Ω/C for the red lead
5. If the GDS-122 confirms continuity (the impedance is less than 50Ω), the beeper sounds.



Freezing the measurement

To freeze the measurement, press the RUN/STOP key. The measurement result will be retained and the indicator at the top right corner of the display changes to STOP. To unfreeze, press the RUN/STOP key again.





# Measuring Capacitance

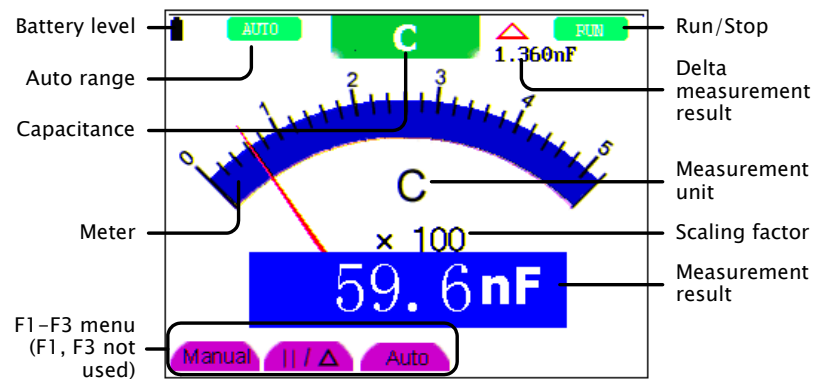

Continuity specifications Range 51.2nF to 100uF ±(3% + 3 digits)

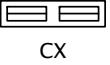

- Panel operations
1. Press the R switch. If a warning message appears, press any key to resume measurement.  
  2. Press the AUTOSET key repeatedly to select the capacitance measurement. 
  3. The capacitance screen appears.

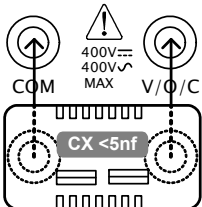

Measuring 5nF and above Connect the test leads to the CX terminals.  CATII 400V

Measuring less than 5nF  Connect the Capacitance Extension module to the COM & V/Ω/C terminals. Then, connect the test leads to the extension module. The measurement result will be constantly updated in the display. 

Freezing the measurement To freeze the measurement, press the RUN/STOP key. The measurement result will be retained and the indicator at the top right corner of the display changes to STOP. To unfreeze, press the RUN/STOP key again.   

Measuring delta capacitance To measure the delta value, press F2 (II/Δ). The measurement result at the moment moves to the top right corner of the display, and the measurement result becomes the difference between the original result.  

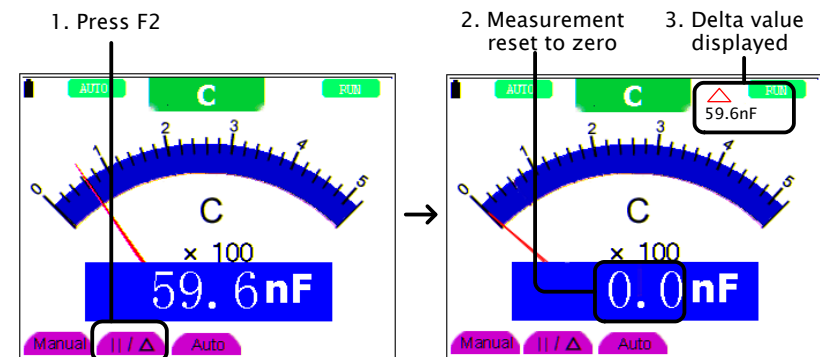

# FAQ

---

|  |   |
|--|---|
| Power                                  | <p>Q • The GDS-122 does not power up.</p> <p>• The GDS-122 stopped working after a short period of time.</p> <p>A The battery may need recharging. Connect the GDS-122 to the AC adaptor and recharge it for at least 15 minutes. Then try powering up.</p>   |
| ERR mode in the multimeter             | <p>Q In the multimeter mode, the measurement type at the top of the display says "ERR" which looks like an error message.</p> <p>A The "ERR" sign appears when none of the measurement switch is pressed. Select one from the V, A, or R switch and press it.</p>   |
| Amplitude mismatch in the oscilloscope | <p>Q The measured voltage is 10 times smaller than the real value.</p> <p>A The attenuation ratio on the probe is set at x10. If you switch it to x1, make sure that the input voltage does not surpass the maximum 400V.</p> <p>Q The measured voltage is 10/100/1000 times larger than the real value.</p> <p>A The probe ratio in the CH1 or CH2 setup menu is set at X10, X100, or X1000. See page22 for details.</p> |
| Unstable waveform in the oscilloscope  | <p>Q The waveform appears in the display but is not stable.</p> <p>A Configuring the trigger might help you. See page30 for details.</p> <ul style="list-style-type: none"> <li>• Make sure the trigger source channel matches the input signal.</li> <li>• Make sure the correct trigger type, edge or</li> </ul>  |

---

video, is selected.

- Try changing the HF and LF repression in the trigger coupling mode and filtering out high or low frequency noise.

---

|                                 |  |
|---------------------------------|--|
| No waveform in the oscilloscope | <p>Q The waveform does not appear at all in the display.</p> <p>A • The trigger level might be out of the waveform range. Press the AUTOSET key so that the GDS-122 automatically adjusts the trigger level.</p> <ul style="list-style-type: none"> <li>• If the trigger mode is Single, press the RUN/STOP key to trigger the waveform or switch the trigger mode to Normal. See page30 for trigger details.</li> </ul> |
| Slow update in the multimeter   | <p>Q It takes 30 to 40 seconds for the multimeter to update the capacitor measurement.</p> <p>A It takes longer time to measure small capacitors. 30 to 40 seconds are normal for measuring 5nF or smaller capacitors. See page93 for capacitance measurement details.</p>   |
| Slow update in the oscilloscope | <p>Q The display response to the waveform change is unusually slow.</p> <p>A Slow response is normal in the following cases.</p> <ul style="list-style-type: none"> <li>• Average sampling mode is being selected (page22)</li> <li>• Display persistence is being selected (page36)</li> </ul>  |

---



# SPECIFICATIONS

Conditions for specifications The following specifications are applicable when these two conditions are met:

- The GDS-122 has been powered up for at least 30 minutes, during which temperature fluctuation is no more than 5 degrees Celsius.
- The probe attenuation is set to X 10.

## Oscilloscope specifications

|            |   |   |
|------------|---|---|
| Sampling   | Mode  | Normal, Peak detection, Average   |
|            | Rate  | 100 MSa/s   |
| Input      | Coupling  | DC, AC  |
|            | Impedance   | 1M $\Omega$ ±2% in parallel with 20pF±3pF   |
|            | Probe   | 1X, 10X, 100X, 1000X  |
|            | Max. Input  | 400V (peak)   |
|            | Channel delay                                     | 150ps (typical)   |
| Horizontal | Sampling rate                                     | 10S/s~100mS/s   |
|            | Interpolation                                     | (sin x) /x  |
|            | Record length                                     | 6K points on each channel   |
|            | Scanning speed                                    | 5ns/div~5s/div, 1-2.5-5 step  |
|            | Sampling rate / relay time accuracy               | ±100ppm (time interval ≥ 1ms)   |
|            | Interval ( $\Delta T$ ) accuracy (full bandwidth) | Single: ±(1 interval time +100ppm×reading+0.6ns) Average >16 : ±(1 interval time +100ppm×reading+0.4ns) |
|            | A/D converter                                     | 8 bits resolution (2CH simultaneously)  |
| Vertical   | Sensitivity                                       | 5mV/div~5V/div (at input)   |
|            | Displacement                                      | ±50V(500mV~5V), ±1V(5mV~200mV)  |
|            | Bandwidth   | 20M   |
|            | Single  | Full bandwidth  |
|            | Low frequency                                     | ≥5Hz (at input, AD coupling, -3dB)  |
|            | Rise time   | ≤17.5ns (at input, typical)   |
|            | DC accuracy                                       | ±5% (DC gain)   |
|            | DC accuracy (avg)                                 | Avg >16: ±(5% rdg + 0.05 div) for $\Delta V$  |

|             |                     |   |                     |
|-------------|---------------------|---|---------------------|
| Trigger     | Sensitivity         | CH1 and CH2: 1div(DC~full bandwidth)<br>DC coupling: ≥ 50Hz.  |                     |
|             | Trigger level       | ±6 divisions from the screen center                           |                     |
|             | Level accuracy      | ±0.3 div (typical, rise/fall time ≥ 20ns)                     |                     |
|             | Displacement        | 655div (pre-trigger), 4div (post-trigger)                     |                     |
|             | 50% level setting   | Input signal frequency ≥ 50Hz (typical)                       |                     |
|             | Trigger sensitivity | 2 div of peak-to-peak (video trigger)                         |                     |
|             | Signal system       | NTSC, PAL, SECAM (any frequency)                              |                     |
| Measurement | Cursor              | $\Delta V$ and $\Delta T$ between cursors                     |                     |
|             | Automatic           | Peak-to-peak, average, root mean square, frequency, and cycle |                     |
| Probe       |                     | 1X position   | 10X position        |
|             | Bandwidth           | ≤ 6 MHz (DC)  | Full bandwidth (DC) |
|             | Attenuation rate    | 1: 1  | 10: 1               |
|             | Compensation        | 10pf~35pf   | 10pf~35pf           |
|             | Input impedance     | 1M $\Omega$ ±2%   | 10M $\Omega$ ±2%    |
|             | Input impedance     | 85pf~115pf  | 14.5pf~17.5pf       |
|             | Input voltage       | 150 V DC  | 300V DC             |

## Multimeter specifications

|     |                 |   |  |
|-----|-----------------|---|--|
| VDC | Input impedance | 10M $\Omega$  |  |
|     | Max input       | 1000V (DC or AC peak-to-peak value)                   |  |
|     | Accuracy        | ±1%±1 digit   |  |
|     | Resolution      | 400mV range: 100uV                                    |  |
|     |                 | 4V range: 1mV<br>40V range: 10mV<br>400V range: 100mV |  |
| VAC | Input impedance | 10M $\Omega$  |  |
|     | Max input       | 750V(AC, virtual value)                               |  |
|     | Frequency range | 40Hz~400Hz  |  |
|     | Display         | Virtual value of sine wave                            |  |
|     | Accuracy        | ±1%±3 digits  |  |
|     | Resolution      | 4V range: 1mV<br>40V range: 10mV<br>400V range: 100mV |  |
| DCA |                 | Accuracy  | 40mA range: ±1%±1 digit<br>400mA range: ±1.5%±1 digit<br>20A range: ±3%±3 digits |
|     |                 | Resolution  | 40mA range: 10uA   |

|             |               |   |
|-------------|---------------|---|
|             |               | 400mA range: 100uA<br>20A range: 10mA   |
| ACA         | Accuracy      | 40mA range: $\pm 1.5\% \pm 3$ digit<br>400mA range: $\pm 2\% \pm 1$ digit<br>20A range: $\pm 5\% \pm 3$ digits    |
|             | Resolution    | 40mA range: 10uA<br>400mA range: 100uA<br>20A range: 10mA   |
| Resistance  | Accuracy      | 400Ω range: $\pm 1\% \pm 3$ digits<br>4kΩ~4MΩ range: $\pm 1\% \pm 1$ digit<br>40MΩ range: $\pm 1.5\% \pm 1$ digit |
|             | Resolution    | 400Ω range: 0.1Ω<br>4kΩ range: 1Ω<br>40kΩ range: 10Ω<br>400kΩ range: 100Ω<br>4MΩ range: 1kΩ<br>40MΩ range: 10kΩ   |
| Capacitance | Accuracy      | $\pm 3\% \pm 3$ digits  |
|             | Resolution    | 51.2nF range: 10pF<br>512nF range: 100pF<br>5.12uF range: 1nF<br>51.2uF range: 10nF<br>100uF range: 100nF         |
| Diode       | Reading range | 0V~1.5V   |
| Continuity  | Threshold     | < 30Ω   |

**General specifications**

|             |             |   |
|-------------|-------------|---|
| Display     | Type        | 3.8" color liquid crystal display                                   |
|             | Resolution  | 320 (horizontal) × 240 (vertical) pixels                            |
|             | Color       | 4096 colors   |
| Power       | Consumption | < 6W  |
|             | Supply      | 100V~240V AC, 50/60Hz   |
|             | DC input    | 8.5VDC, 1500mA  |
| Environment | Operating   | Temperature: 0 to 40 °C(32 to 104 °F)<br>Relative humidity: < 75%   |
|             | Storage     | Temperature: -20 to 60 °C(-4 to 140 °F)<br>Relative humidity: < 75% |
| Mechanical  | Dimension   | 18 cm×11.5cm×4cm  |
|             | Weight      | 690g  |

# DECLARATION OF CONFORMITY

We

**GOOD WILL INSTRUMENT CO., LTD.**

(1) No.7-1, Jhongsing Rd., Tucheng City, Taipei County, Taiwan

(2) No. 69, Lu San Road, Suzhou City (Xin Qu), Jiangsu Sheng, China

declare, that the below mentioned product

**Type of Product: Handheld Digital Storage Oscilloscope & Multimeter**

**Model Number: GDS-122**

is herewith confirmed to comply with the requirements set out in the Council Directive on the Approximation of the Law of Member States relating to Electromagnetic Compatibility (89/336/EEC) and Low Voltage Directive (73/23/EEC).

For the evaluation regarding the Electromagnetic Compatibility and Low Voltage Directive, the following standards were applied:

© **EMC**

|  |                              |
|--|------------------------------|
| EN 61326-1: Electrical equipment for measurement, control and laboratory use — EMC requirements (1997 + A1:1998 + A2:2001 + A3:2003) |                              |
| Current Harmonics  | Voltage Fluctuations         |
| EN 61000-3-2: 2000 + A2:2005   | EN 61000-3-3: 1995 + A1:2001 |
| -----  | -----                        |
| -----  | -----                        |

© **Safety**

|   |
|---|
| Low Voltage Equipment Directive 73/23/EEC |
| Safety Requirements                       |
| IEC/EN 61010-1: 2001 (2nd Edition)        |

# INDEX

---

|                                  |    |
|----------------------------------|----|
| AC coupling                      |    |
| trigger                          | 32 |
| vertical                         | 24 |
| ACA multimeter                   | 87 |
| specifications                   | 99 |
| AC-DC adaptor                    | 10 |
| acquisition                      | 35 |
| short cuts                       | 58 |
| system status                    | 37 |
| ACV multimeter                   | 85 |
| specifications                   | 98 |
| addition, math mode              | 39 |
| auto ranging                     |    |
| impedance multimeter             | 89 |
| voltage multimeter               | 86 |
| auto trigger mode                | 31 |
| AUTO trigger status              | 27 |
| automatic measurements           | 41 |
| shortcuts                        | 57 |
| Autoset                          | 18 |
| capacity multimeter              | 93 |
| continuity, multimeter           | 92 |
| diode, multimeter                | 91 |
| impedance measurement            | 89 |
| voltage multimeter               | 85 |
| average acquisition mode         | 35 |
| application                      | 49 |
| background color, PC software    | 68 |
| battery level                    | 16 |
| calibration                      | 51 |
| short cuts                       | 58 |
| capacitance measurement,         |    |
| multimeter                       | 93 |
| specifications                   | 99 |
| carry, interface setting         | 66 |
| carrying case                    | 10 |
| caution symbol                   | 6  |
| CD-ROM                           | 10 |
| channel                          |    |
| edge trigger                     | 31 |
| on/off                           | 23 |
| video trigger source             | 34 |
| contents of package              | 10 |
| continuity, multimeter           | 92 |
| specifications                   | 99 |
| coupling                         |    |
| system status                    | 38 |
| trigger                          | 32 |
| vertical                         | 24 |
| cursor measurement               |    |
| PC software                      | 75 |
| short cuts                       | 57 |
| time                             | 42 |
| voltage                          | 43 |
| cycle rms, automatic measurement | 41 |
| data point, storing              | 77 |
| data table, PC software          | 77 |
| DC coupling                      |    |
| trigger                          | 32 |
| vertical                         | 24 |
| DCA multimeter                   | 87 |
| specifications                   | 98 |
| DCV multimeter                   | 85 |
| specifications                   | 98 |
| default settings                 | 53 |
| delta measurement                |    |
| capacitance multimeter           | 94 |
| current multimeter               | 88 |
| impedance multimeter             | 90 |
| voltage multimeter               | 86 |
| diode measurement, multimeter    | 91 |
| specifications                   | 99 |
| display                          |    |
| acquiring snapshot               | 67 |
| brightness adjustment            | 16 |
| overview                         | 19 |

|                                  |        |
|----------------------------------|--------|
| settings                         | 36     |
| shortcuts                        | 58     |
| specifications                   | 99     |
| division, math mode              | 39     |
| dot drawing                      | 36     |
| edge trigger                     | 30     |
| auto mode                        | 31     |
| coupling mode                    | 32     |
| mode                             | 31     |
| normal mode                      | 32     |
| single mode                      | 32     |
| EN61000                          | 100    |
| EN61010                          |        |
| declaration of conformity        | 100    |
| measurement category             | 7      |
| pollution degree                 | 7      |
| EN61326-1                        | 100    |
| environment                      |        |
| operation                        | 7      |
| specifications                   | 99     |
| storage                          | 8      |
| ERR mode, multimeter             | 95     |
| extension module                 |        |
| capacitance multimeter           | 93     |
| current multimeter               | 88     |
| package                          | 10     |
| factory settings                 | 53     |
| FAQ                              | 95     |
| ERR mode, multimeter             | 95     |
| magnification                    | 95     |
| no waveform                      | 96     |
| powering up                      | 95     |
| slow update, multimeter          | 96     |
| slow update, oscilloscope        | 96     |
| unstable waveform                | 95     |
| field trigger, video             | 34     |
| freezing measurement             |        |
| capacitance multimeter           | 94     |
| continuity multimeter            | 92     |
| current multimeter               | 88     |
| diode multimeter                 | 91     |
| impedance multimeter             | 90     |
| voltage multimeter               | 86     |
| frequency, automatic measurement | 41     |
| front panel overview             | 12     |
| grid color, PC software          | 69     |
| grid, PC software                | 69     |
| ground symbol                    | 6      |
| help, PC software                | 82     |
| Hf Rjc                           | 32     |
| horizontal                       |        |
| adjusting position               | 20, 25 |
| adjusting scale                  | 19, 26 |
| scale vs trigger status          | 28     |
| short cuts                       | 58     |
| specifications                   | 97     |
| system status                    | 37     |
| impedance, multimeter            | 89     |
| specifications                   | 99     |
| installing PC software           | 62     |
| inverting channel                | 24     |
| language                         |        |
| PC software                      | 70     |
| short cuts                       | 58     |
| LF Rjc                           | 32     |
| line data, PC software           | 69     |
| line trigger, video              | 34     |
| list of features                 | 11     |
| magnification, vertical          | 25     |
| manual ranging                   |        |
| current multimeter               | 88     |
| impedance multimeter             | 90     |
| voltage multimeter               | 86     |
| manual, overview of              | 14     |
| math mode                        | 39     |
| shortcuts                        | 57     |
| system status                    | 38     |
| mean voltage, auto measurement   | 41     |
| multimeter                       |        |
| activating                       | 84     |
| capacitance measurement          | 93     |
| continuity measurement           | 92     |
| current measurement              | 87     |
| diode measurement                | 91     |
| ERR mode                         | 95     |
| impedance measurement            | 89     |
| specifications                   | 98     |
| voltage measurement              | 85     |
| warning message                  | 84     |
| multiplication, math mode        | 39     |
| noisy signal, viewing            | 49     |
| normal trigger mode              | 32     |

|                                      |    |                                       |    |
|--------------------------------------|----|---------------------------------------|----|
| operation environment.....           | 7  | calibration.....                      | 52 |
| OSC option key.....                  | 60 | package.....                          | 10 |
| oscilloscope                         |    | setting attenuation.....              | 17 |
| specifications.....                  | 97 | specifications.....                   | 98 |
| switching to multimeter.....         | 16 | Ready trigger status.....             | 27 |
| package contents.....                | 10 | recalling                             |    |
| PC software                          |    | default settings.....                 | 53 |
| activation.....                      | 65 | default settings, shortcuts.....      | 58 |
| cursor measurement.....              | 75 | waveforms from GDS-122.....           | 55 |
| help.....                            | 82 | waveforms, PC software.....           | 79 |
| installation.....                    | 62 | resetting trigger level.....          | 29 |
| overview.....                        | 61 | run trigger.....                      | 28 |
| package.....                         | 10 | sample acquisition mode.....          | 35 |
| printing out.....                    | 80 | saving                                |    |
| saving waveform.....                 | 77 | shortcuts.....                        | 59 |
| screen overview.....                 | 68 | waveforms in PC software.....         | 77 |
| uninstall.....                       | 64 | waveforms inside GDS-122.....         | 54 |
| version.....                         | 82 | scale                                 |    |
| viewing waveforms.....               | 71 | horizontal.....                       | 26 |
| peak detect acquisition mode.....    | 35 | math mode.....                        | 40 |
| application.....                     | 48 | vertical.....                         | 23 |
| period, automatic measurement.....   | 41 | waveform, PC software.....            | 73 |
| persistence setting.....             | 36 | xy mode.....                          | 47 |
| application.....                     | 50 | zoom.....                             | 46 |
| pk-pk voltage, automatic             |    | Scan trigger status.....              | 27 |
| measurement.....                     | 41 | self calibration.....                 | 51 |
| point data, PC software.....         | 69 | SET1/2, automatic measurement.....    | 41 |
| position                             |    | signal peak, viewing.....             | 48 |
| horizontal.....                      | 25 | single trigger mode.....              | 32 |
| math mode.....                       | 40 | slope, trigger.....                   | 30 |
| shortcuts.....                       | 60 | snapshot, display.....                | 67 |
| time cursor.....                     | 43 | software version.....                 | 82 |
| trigger.....                         | 28 | specifications                        |    |
| vertical.....                        | 23 | general.....                          | 99 |
| voltage cursor.....                  | 44 | multimeter.....                       | 98 |
| waveform, PC software.....           | 72 | oscilloscope.....                     | 97 |
| xy mode.....                         | 47 | stop trigger.....                     | 28 |
| power supply                         |    | STOP trigger status.....              | 27 |
| safety instructions.....             | 7  | storage environment.....              | 8  |
| specifications.....                  | 99 | subtraction, math mode.....           | 39 |
| power up, faq.....                   | 95 | synchronization, video trigger.....   | 34 |
| powering up.....                     | 16 | system status.....                    | 37 |
| print out, PC software.....          | 80 | shortcuts.....                        | 59 |
| probe                                |    | test lead.....                        | 10 |
| adjusting display magnification..... | 17 | threshold, continuity multimeter..... | 92 |
| adjustment tool.....                 | 10 | tilt stand.....                       | 17 |

|                                 |    |                                  |        |
|---------------------------------|----|----------------------------------|--------|
| time cursor.....                | 42 | variations, viewing.....         | 50     |
| Trig'd trigger status.....      | 27 | vector drawing.....              | 36     |
| trigger                         |    | vertical                         |        |
| adjusting level.....            | 28 | adjusting position.....          | 20, 23 |
| auto mode.....                  | 31 | adjusting scale.....             | 19, 23 |
| channel, edge trigger.....      | 31 | inverting channel.....           | 24     |
| coupling mode.....              | 32 | selecting coupling mode.....     | 24     |
| edge triggering.....            | 30 | selecting magnification.....     | 25     |
| mode.....                       | 31 | shortcuts.....                   | 56     |
| normal mode.....                | 32 | specifications.....              | 97     |
| run/stop.....                   | 28 | system status.....               | 38     |
| shortcuts.....                  | 56 | video trigger.....               | 33     |
| single mode.....                | 32 | field trigger.....               | 34     |
| slope.....                      | 30 | line trigger.....                | 34     |
| source channel, video.....      | 34 | source channel.....              | 34     |
| specifications.....             | 98 | sync.....                        | 34     |
| status icons.....               | 27 | voltage cursor.....              | 43     |
| status vs horizontal scale..... | 28 | warning message, multimeter..... | 84     |
| sync, video trigger.....        | 34 | warning symbol.....              | 6      |
| system status.....              | 38 | xy mode.....                     | 47     |
| video.....                      | 33 | system status.....               | 37     |
| UK power cord.....              | 8  | zoom waveform.....               | 45     |
| USB driver installation.....    | 65 | system status.....               | 37     |