

REV	ECN NO.	DATE
A	N/A	2010/08/15

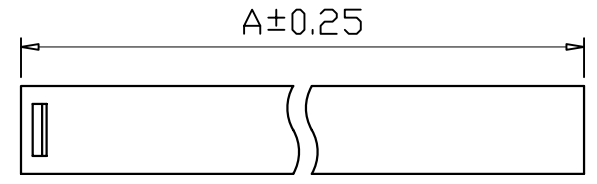

Material:  
 Insulator: PBT+30% Glass Fiber (UL94V-0).  
 Contact: Copper Alloy.  
 Contact Plated: Gold or Tin over Nickel Plated.

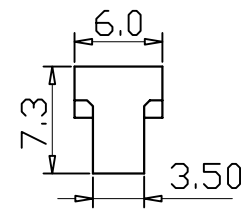
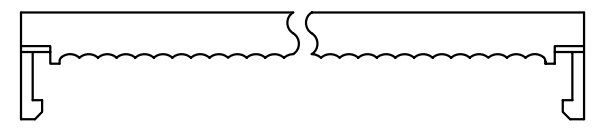

Specification:  
 Current Rating: 1 Amp.  
 Withstanding Voltage: AC 500V for 1 Minute.  
 Insulation Resistance: 1000M $\Omega$  Min. at DC 500V.  
 Contact Resistance: 15 $\Omega$  Max..  
 Operating Temperature: -40°C ~ +105°C.  
 (標※處為重點檢驗尺寸)

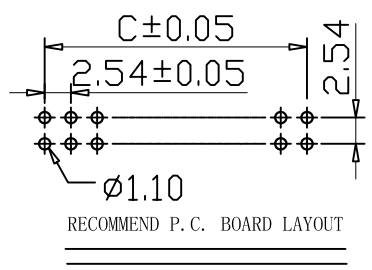
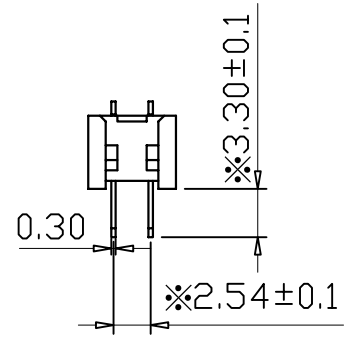
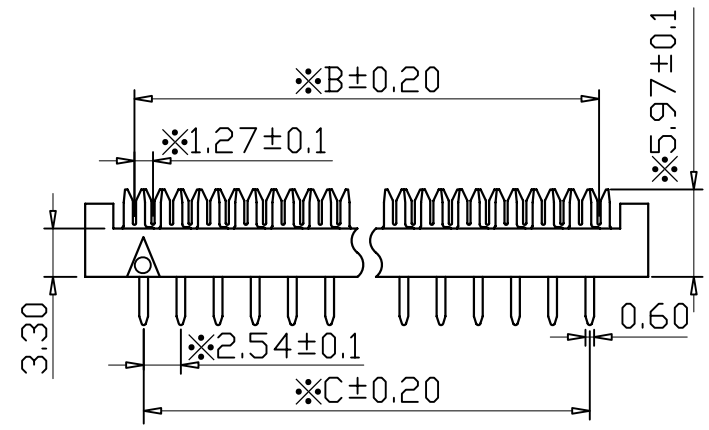

Pos.	Dim. A	Dim. B	Dim. C
6	13.07	6.35	5.08
8	15.61	8.89	7.62
10	18.15	11.43	10.16
12	20.69	13.97	12.70
14	23.23	16.51	15.24
16	25.77	19.05	17.78
18	28.31	21.59	20.32
20	30.85	24.13	22.86
24	35.93	29.21	27.94
26	38.47	31.75	30.48
30	43.55	36.83	35.56
34	48.63	41.91	40.64
36	51.17	44.45	43.18
40	56.25	49.53	48.26
50	68.95	62.23	60.96
60	81.65	74.93	73.66
64	86.73	80.01	78.74

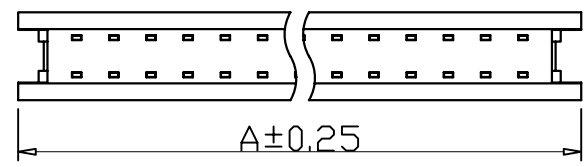

5	SIGNATURE	DATE	TITLE:		CODE NO.	-----	TOLERANCE: X. ±0.2 .X ±0.1 .XX ±0.05 .XXX ±0.02 ANG.	
	DRN.	GRP	2010/08/15	2.54mm DIP Connector		CUS. NO.		-----
	CHK.			Q&T P/N:	CUS. P/N:			
	APP.			-----	-----			

深圳市深琪博电子有限公司

DRAWING NO.

NO

F/成品圖/DIP系列