



■ Features :

- Universal AC input / Full range (up to 295VAC)
- Built-in active PFC function
- High efficiency 89%
- Protections: Short circuit / Overload / Over voltage / Over temperature
- Cooling by free air convection
- IP67 design for indoor or outdoor installations
- UL1310 Class 2 power unit
- Pass LPS
- 100% full load burn-in test
- High reliability
- Suitable for LED lighting and moving sign applications (Note.2)
- Compliance to worldwide safety regulations for lighting
- Suitable for dry / damp / wet locations
- 3 years warranty



SPECIFICATION

MODEL		CLG-60-12	CLG-60-15	CLG-60-20	CLG-60-24	CLG-60-27	CLG-60-36	CLG-60-48	
OUTPUT	DC VOLTAGE	12V	15V	20V	24V	27V	36V	48V	
	CONSTANT CURRENT REGION Note.5	8.4 ~ 12V	10.5 ~ 15V	14 ~ 20V	16.8 ~ 24V	18.9 ~ 27V	25.2 ~ 36V	33.6 ~ 48V	
	RATED CURRENT	5A	4A	3A	2.5A	2.3A	1.7A	1.3A	
	CURRENT RANGE	0 ~ 5A	0 ~ 4A	0 ~ 3A	0 ~ 2.5A	0 ~ 2.3A	0 ~ 1.7A	0 ~ 1.3A	
	RATED POWER	60W	60W	60W	60W	62.1W	61W	62.5W	
	RIPPLE & NOISE (max.) Note.2	2Vp-p	2.4Vp-p	1.8Vp-p	2.7Vp-p	2.7Vp-p	3.6Vp-p	4.6Vp-p	
	VOLTAGE ADJ. RANGE	11.5 ~ 13V	14.5 ~ 16.2V	19.5 ~ 22V	24 ~ 26V	25 ~ 30V	32.5 ~ 39V	43.6 ~ 51.8V	
		Fixed can be modified between the range above							
	CURRENT ADJ. RANGE	Fixed. Can be modified between 3% ~ -25% rated output current							
	VOLTAGE TOLERANCE Note.3	±10%							
LINE REGULATION	±3.0%								
LOAD REGULATION	±5.0%								
SETUP TIME	3000ms / 230VAC 5000ms / 115VAC at full load								
INPUT	VOLTAGE RANGE Note.4	90 ~ 295VAC		127 ~ 417VDC					
	FREQUENCY RANGE	47 ~ 63Hz							
	POWER FACTOR (Typ.)	PF>0.94/115VAC, PF>0.9/230VAC, PF>0.9/277VAC at full load (Please refer to "Power Factor Characteristic" curve)							
	EFFICIENCY (Typ.)	85%	86%	87.5%	87%	88%	89%	89%	
	AC CURRENT (Typ.)	0.8A/115VAC		0.4A/230VAC					
	INRUSH CURRENT(max.)	40A/230VAC							
	LEAKAGE CURRENT	<0.75mA / 240VAC							
PROTECTION	OVER CURRENT	95 ~ 110%							
		Protection type : Constant current limiting, recovers automatically after fault condition is removed							
	SHORT CIRCUIT	Hiccup mode, recovers automatically after fault condition is removed							
	OVER VOLTAGE	13.8 ~ 16V	17.5 ~ 21V	23 ~ 26V	28 ~ 32V	31 ~ 35V	41 ~ 46V	54 ~ 60V	
		Protection type : Shut down o/p voltage, re-power on to recover							
OVER TEMPERATURE		12V: 90°C ±10°C (TSW1) detect on heatsink of power transistor							
		15V ~ 48V: 85°C ±10°C (TSW1) detect on heatsink of power transistor							
		Protection type : Shut down o/p voltage, recovers automatically after temperature goes down							
ENVIRONMENT	WORKING TEMP.	-30 ~ +70°C (Refer to "Derating Curve")							
	WORKING HUMIDITY	20 ~ 95% RH non-condensing							
	STORAGE TEMP., HUMIDITY	-40 ~ +80°C, 10 ~ 95% RH							
	TEMP. COEFFICIENT	±0.03%/°C (0 ~ 50°C)							
	VIBRATION	10 ~ 500Hz, 5G 12min./1cycle, period for 72min. each along X, Y, Z axes							
SAFETY & EMC	SAFETY STANDARDS	UL879, UL8750, UL1310 Class 2, TUV EN61347-1, EN61347-2-13 independent, CAN/CSA C22.2 No. 223-M91(except for 48V); J61347-1, J61347-2-13(20~27only), IP67 approved							
	WITHSTAND VOLTAGE	I/P-O/P:3.75KVAC I/P-FG:1.88KVAC O/P-FG:0.5KVAC							
	ISOLATION RESISTANCE	I/P-O/P:100M Ohms / 500VDC / 25°C / 70% RH							
	EMC EMISSION	Compliance to EN55015, EN55022 (CISPR22) Class B, EN61000-3-2 Class C (≥ 75% load); EN61000-3-3							
EMC IMMUNITY	Compliance to EN61000-4-2,3,4,5,6,8,11, EN55024, EN61547, light industry level (surge 4KV), criteria A								
OTHERS	MTBF	495.7Khrs min. MIL-HDBK-217F (25°C)							
	DIMENSION	195.6*61.5*38.8mm (L*W*H)							
	PACKING	0.86Kg; 16pcs/14.8Kg/0.54CUFT							
NOTE	<ol style="list-style-type: none"> 1. All parameters NOT specially mentioned are measured at 230VAC input, rated load and 25°C of ambient temperature. 2. Ripple & noise are measured at 20MHz of bandwidth by using a 12" twisted pair-wire terminated with a 0.1uf & 47uf parallel capacitor. 3. Tolerance : includes set up tolerance, line regulation and load regulation. 4. Derating may be needed under low input voltage. Please check the static characteristics for more details. 5. Constant current operation region is within 70% ~ 100% rated output voltage. This is the suitable operation region for LED related applications, but please reconfirm special electrical requirements for some specific system design. 6. The power supply is considered as a component that will be operated in combination with final equipment. Since EMC performance will be affected by the complete installation, the final equipment manufacturers must re-qualify EMC Directive on the complete installation again. 7. Direct connecting to LEDs is suggested, but is not suitable for using additional drivers. 								

■ Mechanical Specification

Case No. 957A Unit:mm

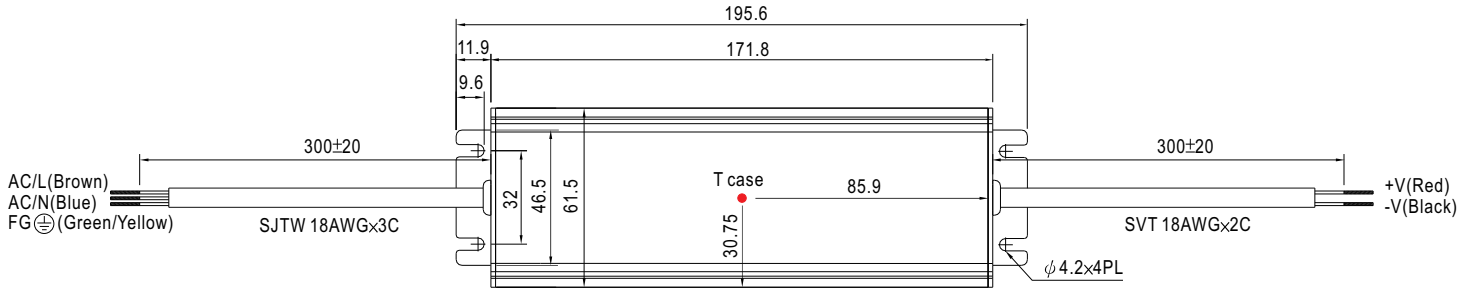

※ T case: Max. Case Temperature.



■ Block Diagram

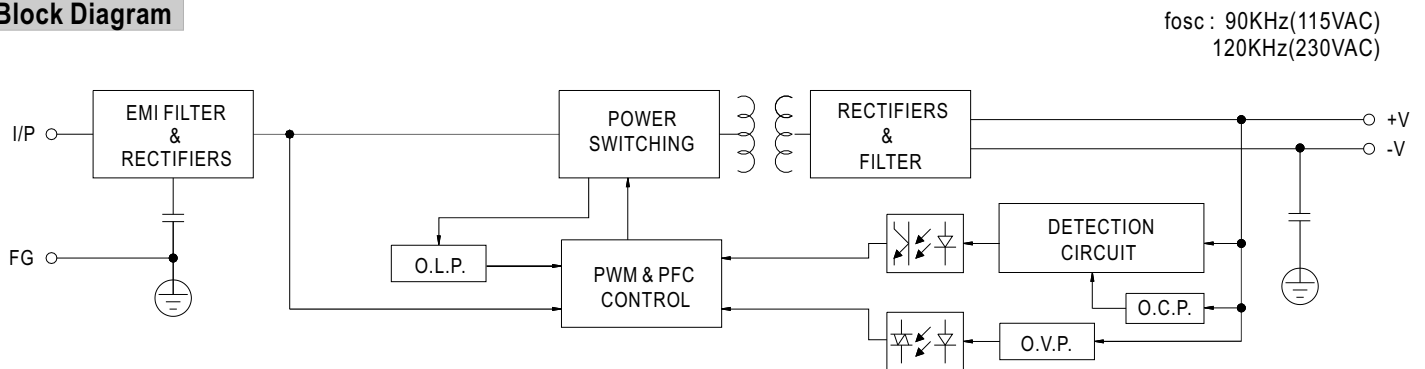

■ Derating Curve

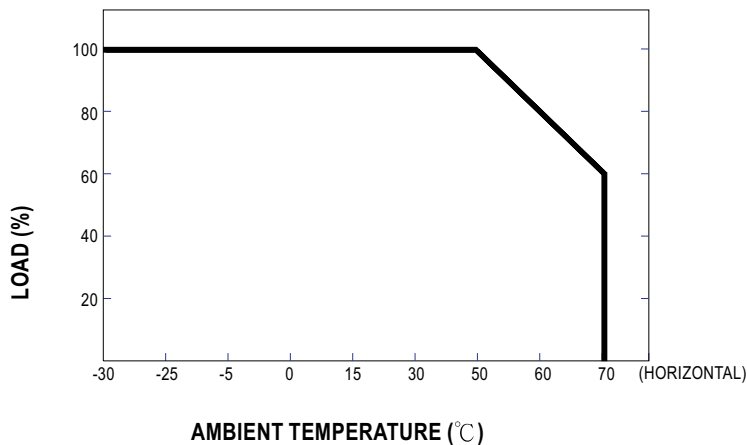

■ Static Characteristics

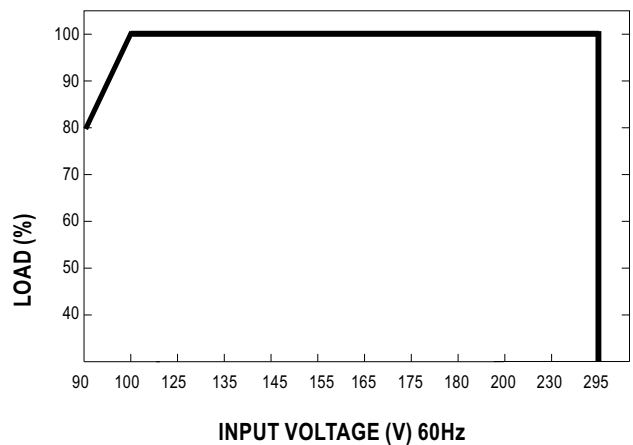

Power Factor Characteristic

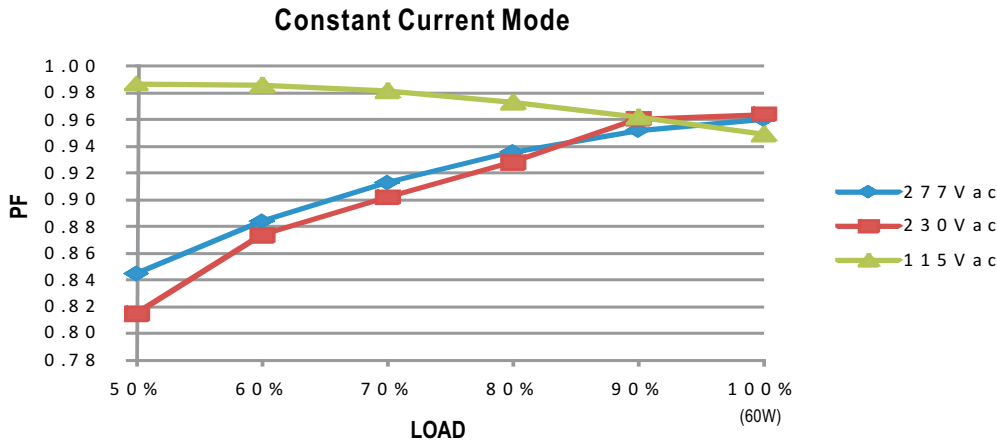

EFFICIENCY vs LOAD (48V Model)

CLG-60 series possess superior working efficiency that up to 89% can be reached in field applications.

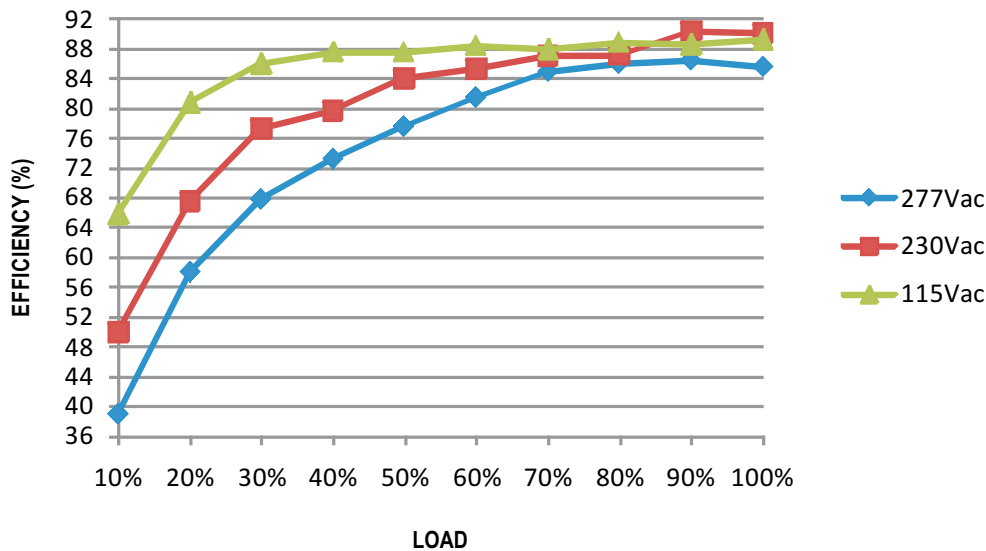

DRIVING METHODS OF LED MODULE

There are two major kinds of LED drive method "direct drive" and "with LED driver".

A typical LED power supply may either work in "constant voltage mode (CV) or constant current mode (CC)" to drive the LEDs.

Mean Well's LED power supply with CV+ CC characteristic can be operated at both CV mode [with LED driver, at area (A)] and CC mode [direct drive, at area (B)].

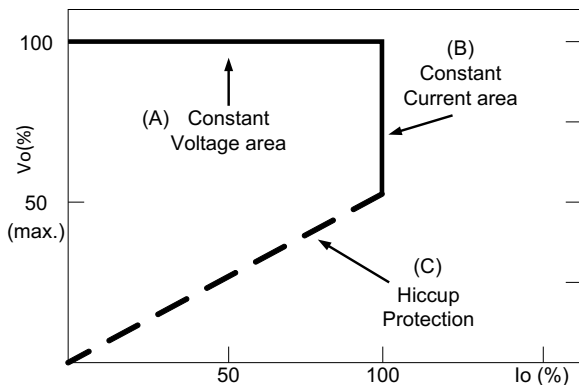

Typical LED power supply I-V curve