

I²C BUS compatible serial EEPROM

BR24C32 / BR24C32F / BR24C64 / BR24C64F

The BR24C32 and BR24C64 series are 2-wire (I²C BUS type) serial EEPROMs which are electrically programmable.

* I²C BUS is a registered trademark of Philips.

●Features

- 1) 4k x 8 bits (32k) serial EEPROM.
(BR24C32 / F)
- 8k x 8 bits (64k) serial EEPROM.
(BR24C64 / F)
- 2) Two wire serial interface. (2Byte Address: BR24E16)
- 3) Operating voltage range: 2.7V ~ 5.5V
- 4) Low current consumption
Active (at 5V) : 2.0mA (Typ.)
Standby (at 5V) : 1.0μA (Typ.)
- 5) Auto erase and auto complete functions can be used during write operations.
- 6) Page write function.
BR24C32 / F: 32 bytes
BR24C64 / F: 64 bytes
- 7) DATA security
Write protect feature
Inhibit to WRITE at low V_{cc}
- 8) Noise filters at SCL and SDA pins.
- 9) Address can be incremented automatically during read operations.
- 10) Compact packages.
- 11) Rewriting possible up to 100,000 times.
- 12) Data can be stored for ten years without corruption.

●Absolute maximum ratings (Ta=25°C)

Parameter	Symbol	Limits	Unit
Supply voltage	V _{cc}	-0.3~+6.5	V
Power dissipation	Pd	450(SOP8) *1	mW
		800(DIP8) *2	
Storage temperature range	T _{stg}	-65~+125	°C
Operating temperature range	T _{opr}	-40~+85	°C
Terminal voltage	-	-0.3~V _{cc} +0.3	V

*1 Reduced by 4.5mW for each increase in Ta of 1°C over 25°C.

*2 Reduced by 8.0mW for each increase in Ta of 1°C over 25°C.

●Recommended operating conditions (Ta=25°C)

Parameter	Symbol	Limits	Unit
Supply voltage	V _{cc}	2.7~5.5	V
Input voltage	V _{IN}	0~V _{cc}	V

BR24C32 / BR24C32F / BR24C64 / BR24C64F

Memory ICs

●Block diagram

BR24C32 / F

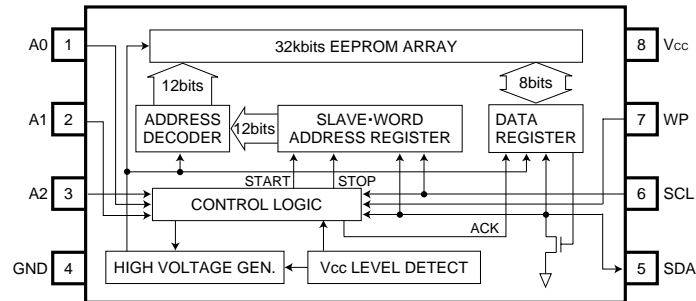

BR24C64 / F

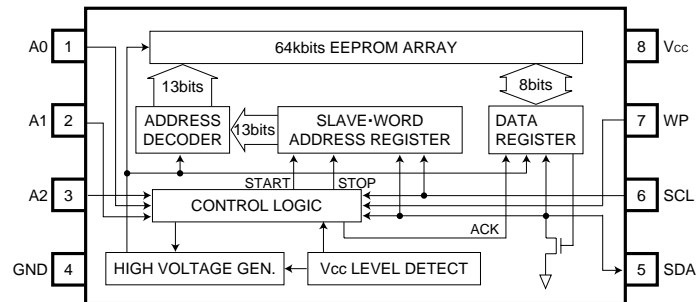

●Pin descriptions

Pin name	I / O	Function
Vcc	-	Power supply
GND	-	Ground (0V)
A0, A1, A2	I	Slave address set
SCL	I	Serial clock input
SDA	I / O	Slave and word address, serial data input, serial data output *
WP	I	Write protect input

*An open drain output requires a pull-up resistor.

BR24C32 / BR24C32F / BR24C64 / BR24C64F

Memory ICs

●Electrical characteristics

DC characteristics (Unless otherwise noted, Ta=-40-85°C, Vcc=2.7-5.5V)

Parameter	Symbol	Min.	Typ.	Max.	Unit	Conditions
"HIGH" Input voltage	V _{IH}	0.7V _{CC}	-	-	V	-
"LOW" Input voltage	V _{IL}	-	-	0.3V _{CC}	V	-
"LOW" Output voltage	V _{OL}	-	-	0.4	V	I _{OL} =3.0mA(SDA)
Input leakage current	I _I	-1.0	-	1.0	μA	V _{IN} =0V~V _{CC}
Output leakage current	I _{LO}	-1.0	-	1.0	μA	V _{OUT} =0V~V _{CC}
Operating current	I _{CC}	-	-	3.0	mA	V _{CC} =5.5V, f _{SCL} =400kHz
Standby current	I _{SB}	-	-	3.0	μA	V _{CC} =5.5V, SDA·SCL=V _{CC} A0, A1, A2=GND, WP=GND

© This product is not designed for protection against radioactive rays.

Operating timing characteristics (Unless otherwise noted, Ta=-40-85°C, Vcc=2.7-5.5V)

Parameter	Symbol	Vcc=5V±10%			Vcc=3V±10%			Unit
		Min.	Typ.	Max.	Min.	Typ.	Max.	
Clock frequency	f _{SCL}	-	-	400	-	-	100	kHz
Data clock "HIGH" period	t _{HIGH}	0.6	-	-	4.0	-	-	μs
Data clock "LOW" period	t _{LOW}	1.2	-	-	4.7	-	-	μs
SDA and SCL rise time	t _R	-	-	0.3	-	-	1.0	μs
SDA and SCL fall time	t _F	-	-	0.3	-	-	0.3	μs
Start condition hold time	t _{HD} : STA	0.6	-	-	4.0	-	-	μs
Start condition setup time	t _{SU} : STA	0.6	-	-	4.7	-	-	μs
Input data hold time	t _{HD} : DAT	0	-	-	0	-	-	ns
Input data setup time	t _{SU} : DAT	100	-	-	250	-	-	ns
Output data delay time	t _{PD}	0.1	-	0.9	0.2	-	3.5	μs
Output data hold time	t _{DH}	0.1	-	-	0.2	-	-	μs
Stop condition setup time	t _{SU} : STO	0.6	-	-	4.7	-	-	μs
Bus free time	t _{BUF}	1.2	-	-	4.7	-	-	μs
Write cycle time	t _{WR}	-	-	10	-	-	10	ms
Noise spike width (SDA and SCL)	t _i	-	-	0.05	-	-	0.1	μs

Memory ICs

●Timing charts

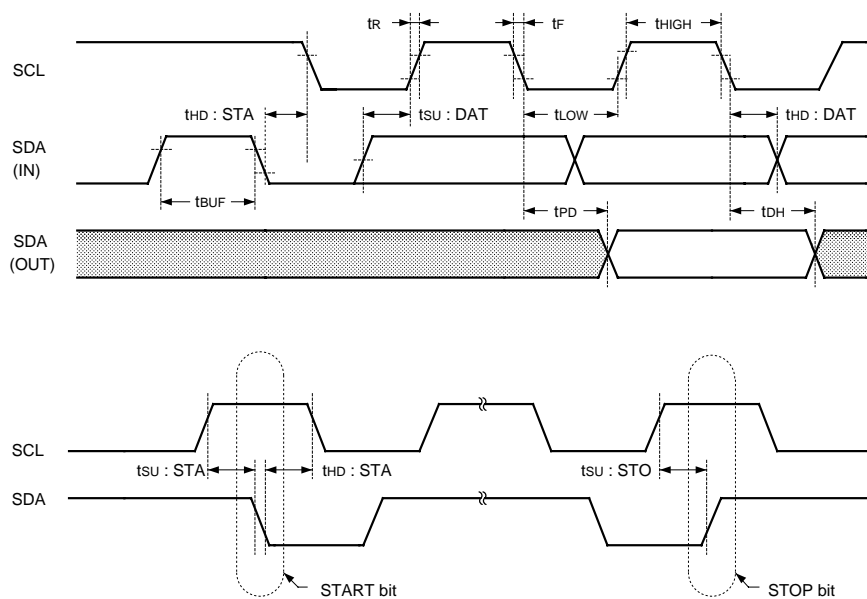

- Data is read on the rising edge of SCL.
- Data is output in synchronization with the falling edge of SCL.

Fig.1 Synchronized data input / output timing

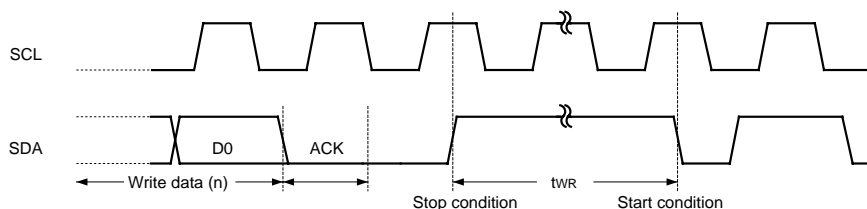

Fig.2 Write cycle timing

●Circuit operation

(1) Start condition (recognition of start bit)

Before executing any command, when SCL is HIGH, a start condition (start bit) is required to cause SDA to fall from HIGH and LOW. This IC is designed to constantly detect whether there is a start condition (start bit) for the SDA and SCL line, and no commands will be executed unless this condition is satisfied.

(See Fig.1 for the synchronized data input / output timing.)

(2) Stop condition (recognition of stop bit)

To stop any command, a stop condition (stop bit) is required. A stop condition is achieved when SDA goes from LOW to HIGH while SCL is HIGH. This enables commands to be completed.

(See Fig.1 for the synchronized data input / output timing.)

BR24C32 / BR24C32F / BR24C64 / BR24C64F

Memory ICs

(3) Precautions concerning write commands

In the WRITE mode, the transferred data is not written to the memory unless the stop bit is executed.

(4) Device addressing

- 1) Make sure the slave address is output from the master immediately after the start condition.
- 2) The upper 4 bits of the slave address are used to determine the device type. The device code for this IC is fixed at "1010".
- 3) The next 3 bits of the slave address (A2, A1, A0 ... device address) are used to select the device. This IC can address up to eight devices on the same bus.
- 4) The lowermost bit of the slave address (R/\overline{W} ... READ / \overline{WRITE}) is used to set the write or read mode as follows.
 - R / \overline{W} set to 0 ... Write
 - (Random read word address setting is also 0)
 - R / \overline{W} set to 1 ... Read

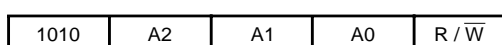

(5) Write protect functions (WP)

When WP pin set to Vcc (High level), write protect is set by all address. When WP pin set to GND (Low level), enable to write to all address. Either control this pin or connect to GND (or Vcc). It is inhibited from being left unconnected.

(6) ACK signal

The acknowledge signal (ACK signal) is determined by software and is used to indicate whether or not a data transfer is proceeding normally. The transmitting device, whether the master or slave, opens the bus after an 8 bits data output (μ -COM when a write or read command of the slave address input; this IC when reading data).

For the receiving device during the ninth clock cycle, SDA is set to LOW and an acknowledge signal (ACK signal) is sent to indicate that it received the 8 bits data (this IC when a write command or a read command of the slave address input, μ -COM when a read command data output).

The ICs output a LOW acknowledge signal (ACK signal) after recognizing the start condition and slave address (8 bits). When data is being write to the ICs a LOW acknowledge signal (ACK signal) is output after the receipt of each 8 bits of data (word address and write data).

When data is being read from the IC, 8 bits of data (read data) are output and the IC waits for a returned LOW acknowledge signal (ACK signal). When an acknowledge signal (ACK signal) is detected and a stop condition is not sent from the master (μ -COM) side, the IC continues to output data. If an acknowledge signal (ACK signal) is not detected, the IC interrupts the data transfer and ceases reading operations after recognizing the stop condition (stop bit). The IC then enters the waiting or standby state.

(See Fig.3 for acknowledge signal (ACK signal) response.)

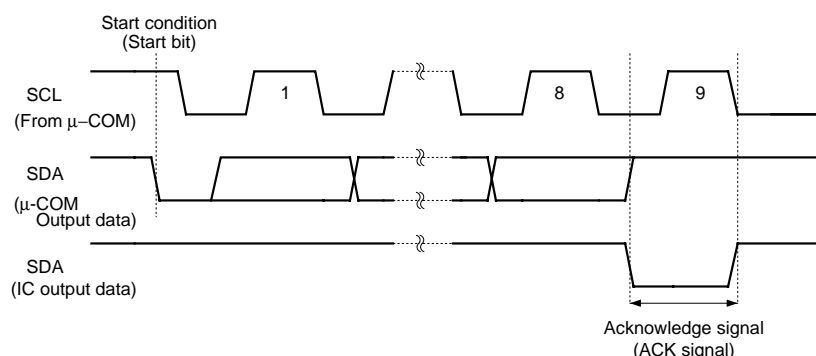

Fig.3 Acknowledge (ACK signal) response
(during write and read slave address input)

BR24C32 / BR24C32F / BR24C64 / BR24C64F

Memory ICs

(7) Byte write cycle
BR24C32 / F

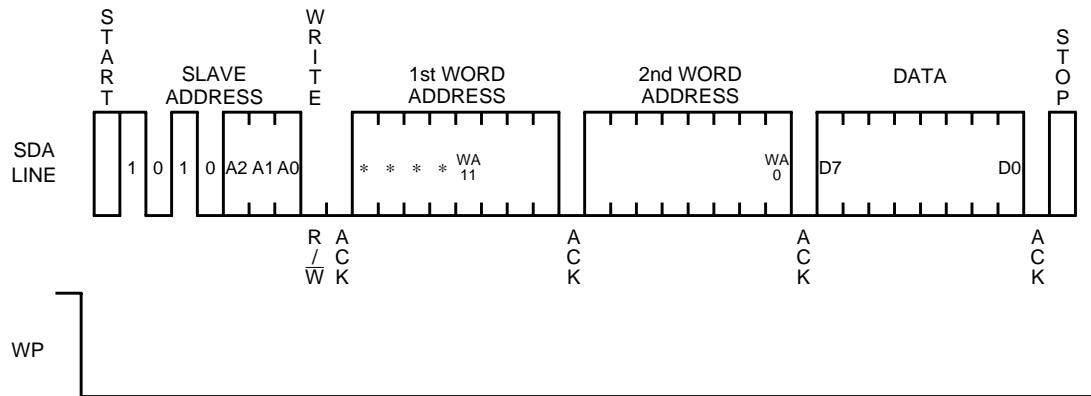

Fig.4

BR24C64 / F

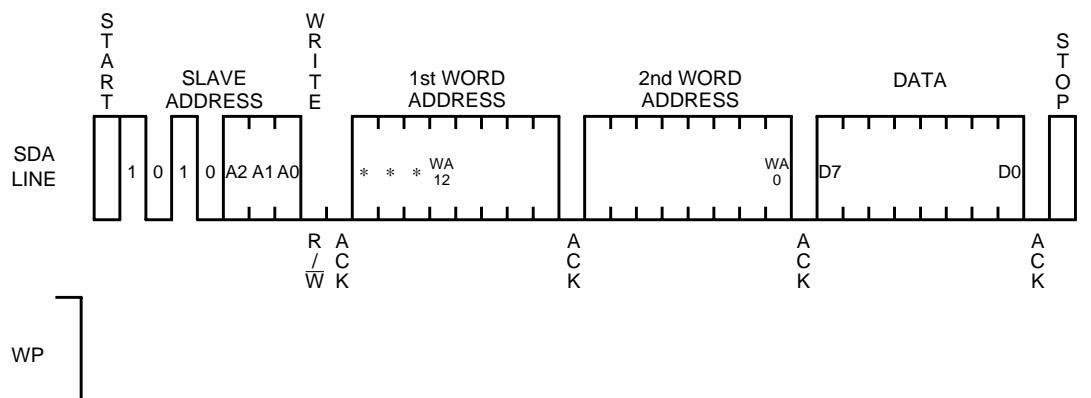

Fig.5

- Data is written to the address designed by the word address (n address).
- After 8 bits of data are input, the data is written to the memory cell by issuing the stop bit.

BR24C32 / BR24C32F / BR24C64 / BR24C64F

Memory ICs

(8) Page write cycle BR24C32 / F

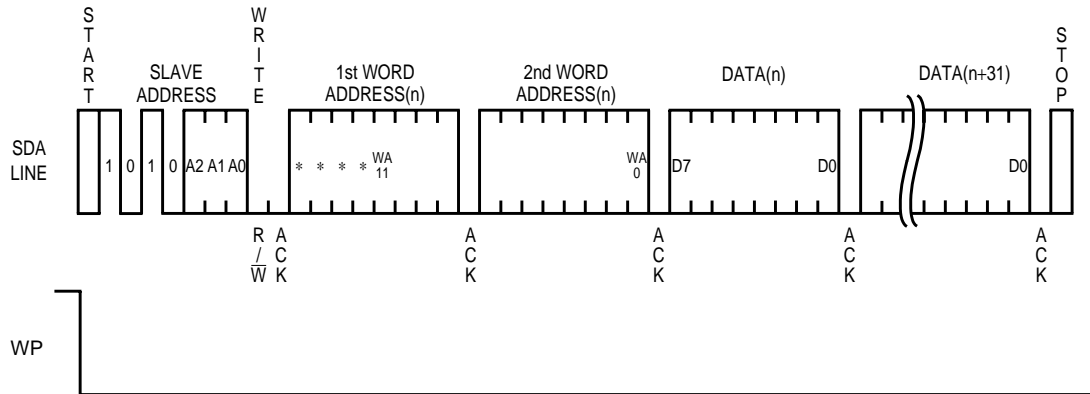

Fig.6

BR24C64 / F

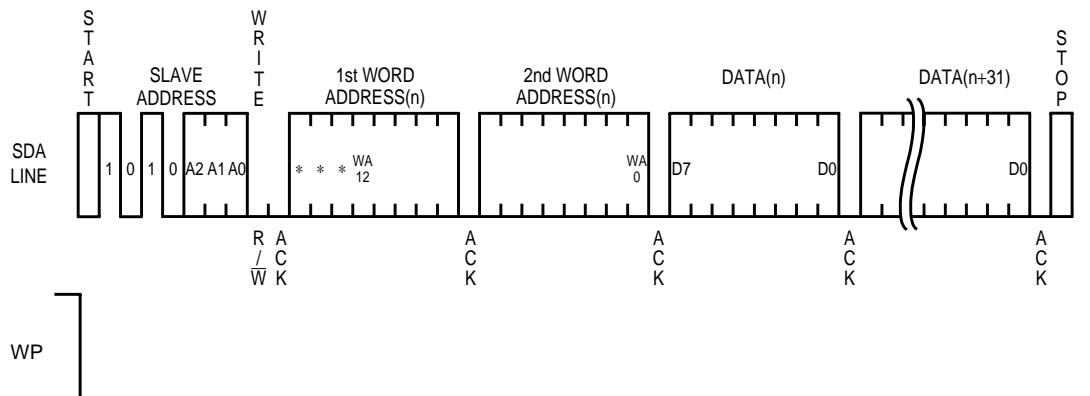

Fig.7

·A 32 bytes write is possible using this command.

·The page write command arbitrarily sets the upper 7 bits (WA11 to WA5) of the word address. The lower 5 bits (WA4 and WA0) can write up to 32 bytes of data with the address being incremented internally.

(9) Current read cycle

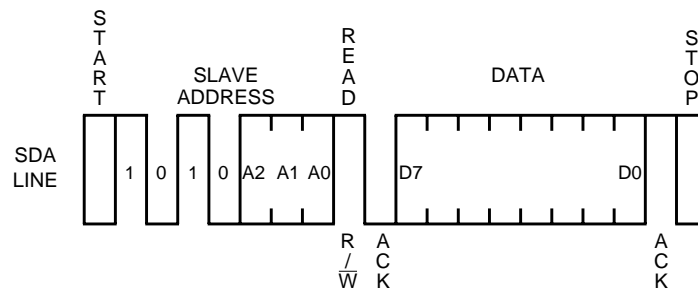

Fig.8

BR24C32 / BR24C32F / BR24C64 / BR24C64F

Memory ICs

·In case the previous operation is random or current read (which includes sequential read respectively), the internal address counter is increased by one from the last accessed address (n). Thus current read outputs the data of the next word address (n+1).

If the last command is byte or page write, the internal address counter stays at the last address (n). Thus current read outputs the data of the word address (n).

If the master does not transfer the acknowledge but does generate a stop condition, the current address read operation only provides single byte of data. At this point, this IC discontinues transmission.

·When an ACK signal LOW is detected after D0 and a stop condition is not sent from the master (μ-COM), the next word address data can be read.

(See Fig.8 for the sequential read cycles.)

·This command is ended by inputting HIGH to the ACK signal after D0 and raising the SDA signal (stop condition) by setting SCL to HIGH.

(10) Random read cycle

BR24C32 / F

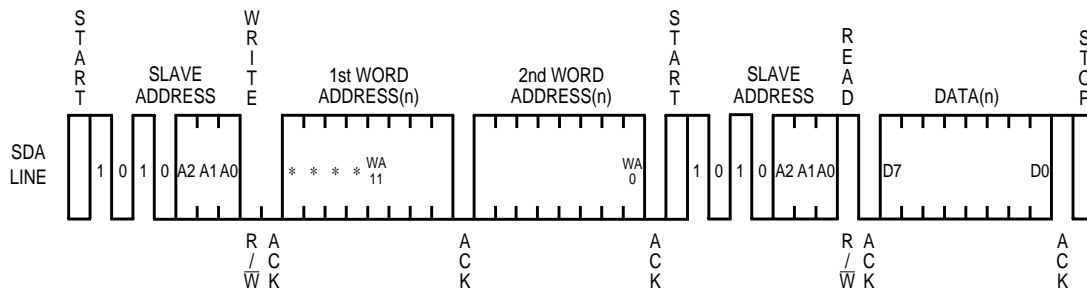

Fig.9

BR24C64 / F

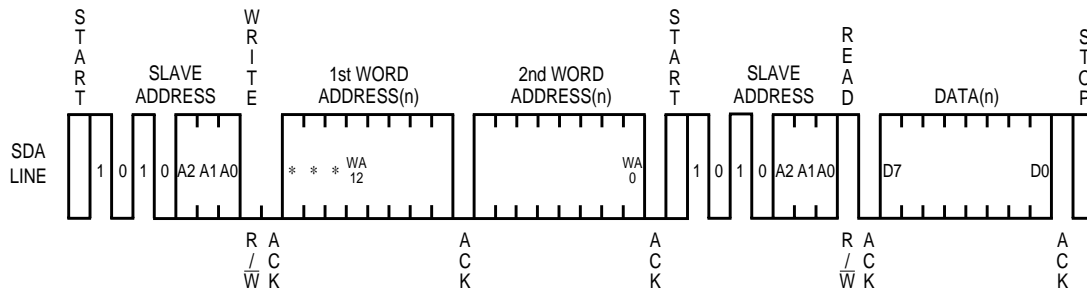

Fig.10

·This command can read the designated word address data.

·When an ACK signal LOW is detected after D0 and a stop condition is not sent from the master (μ-COM), the next word address data can be read.

(See Fig.8 for the sequential read cycles.)

·This command is ended by inputting a HIGH signal to the ACK signal after D0 and raising the SDA signal (stop condition) by raising SCL to HIGH.

BR24C32 / BR24C32F / BR24C64 / BR24C64F

Memory ICs

(11) Sequential read cycle

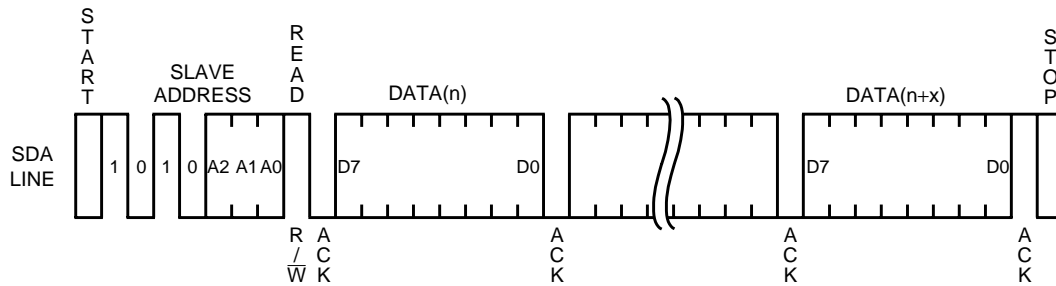

Fig.11

- When an ACK signal LOW is detected after D0 and a stop condition is not sent from the master (μ -COM), the next word address data can be read.
- This command is ended by inputting a HIGH signal to the ACK signal after D0 and raising the SDA signal (stop condition) by using the SCL and HIGH.
- Sequential reading can also be done with a random read.

●External dimension (Units : mm)

