

AG1

ZERO MERCURY

Alkaline Button Cell



Dimensions

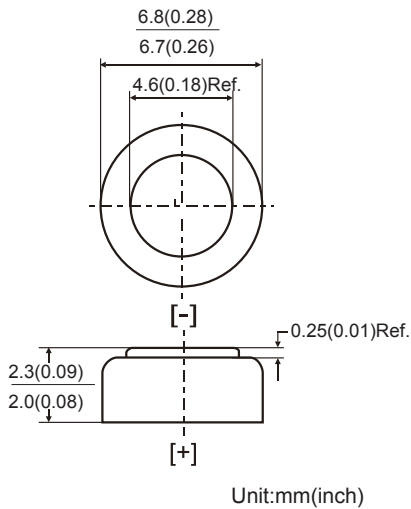

Specifications

Chemical System:	Alkaline (Zn/MnO ₂) (Zinc-Manganese Dioxide)
IEC Name:	LR60
Camelion Model:	AG1 (LR621)
Average Weight:	0.30g
Dimension (ΦxH):	6.8 x 2.15mm 0.27 x 0.08 inch
Terminals:	Flat
Nominal Voltage:	1.5Volts
Capacity:	14mAh (Rated at 45kohm to 0.9V)
Operating Temperature:	-18°C - 55°C
Storage Temperature:	15°C - 25°C
Relative Humidity:	60±15%

Usage Guide



Watch



Calliper



Calculator

Typical Discharge Testing

Typical characteristics at 21 °C

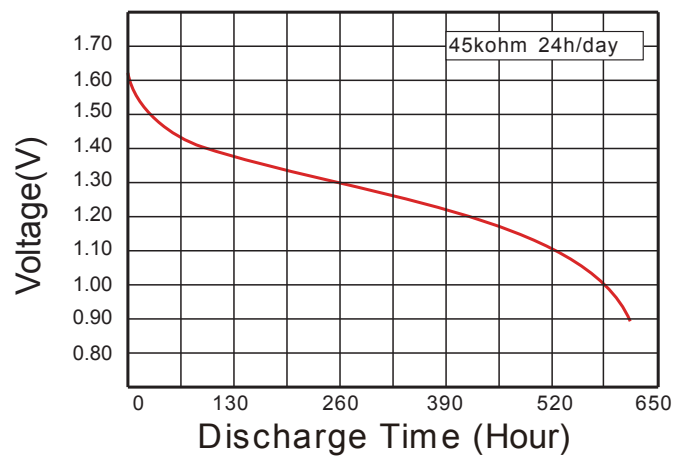

Notice:

Environmental elements comply with 2006/66/EC and US LAW 104-142 requirements. This data sheet is typical information specific to products manufactured at the time of its publication. Contact Camelion Battery Co., Ltd. for the latest information.