

AC1020 • 20 Amp Current Transformer

Low Cost 50/60Hz Current Transformers

Applications

- Sensing Overload Current
- Ground fault detection
- Metering
- Analog to Digital Circuits

Features

- Competitive pricing due to high volume production
- Confirms to UL94V-0
- Manufactured in an ISO 9001:2015 and ISO 14001:2015 certified Talema facility
- Fully RoHS & REACH Compliant

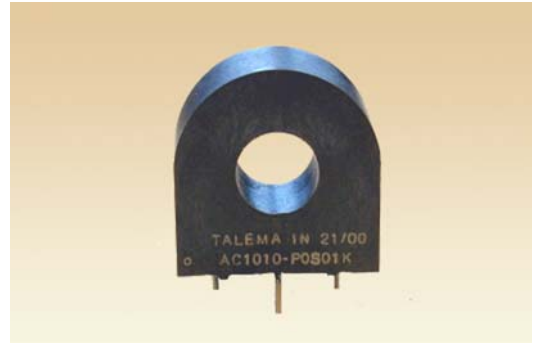

Electrical Specifications @ 20°C ambient	
Primary Current	20A nom., 60A max.
Turns Ratio	1000:1 nominal
Volt per Amp Ratio at 20A for 100 Ohms load	0.100 V/A
Volt per Amp Ratio at 2A for 100 Ohms load	0.097 V/A
DC Resistance at 20°C	41.8 Ohms
Dielectric Withstanding Voltage (Hi-pot)	4KVrms

Environmental Specifications	
Storage Temperature	-55° to +130°C
Insulation Resistance	100 megohms min.

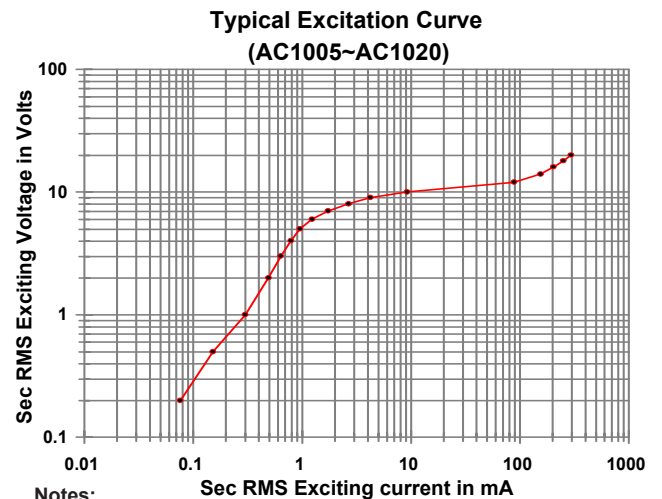
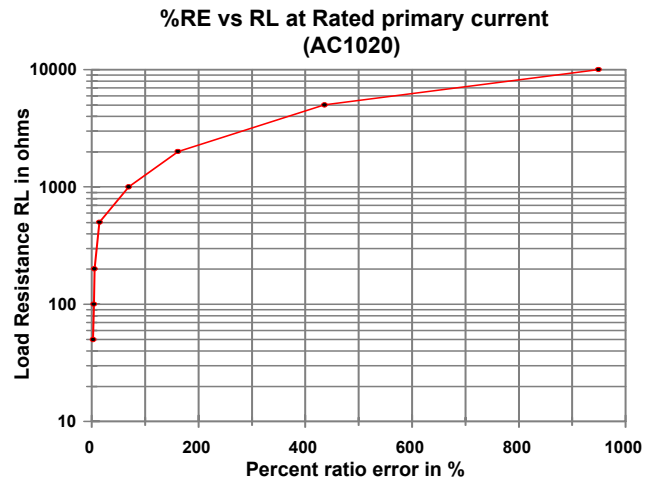
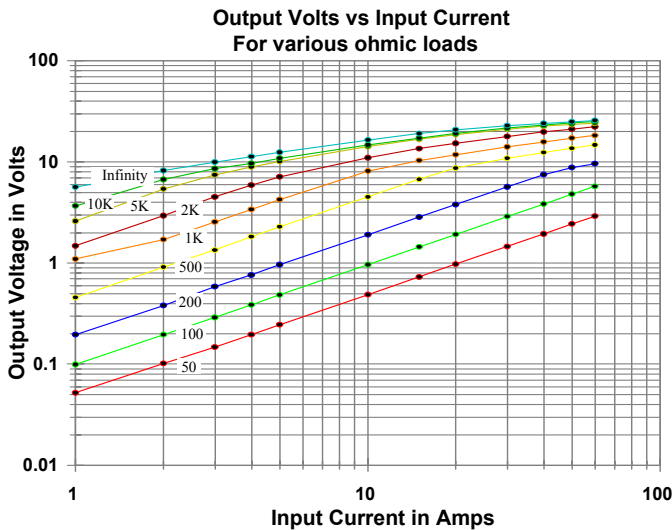

Mechanical Drawing

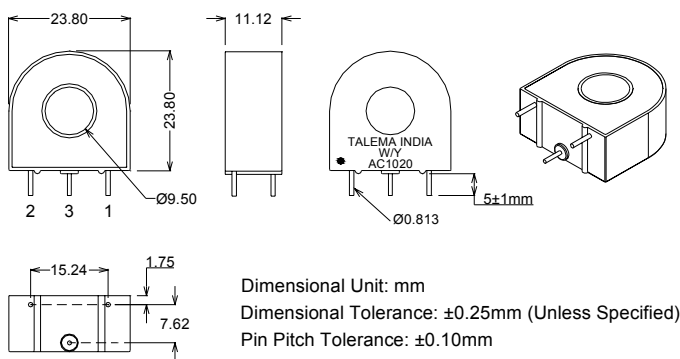

Notes:

- 1) Unless requested, the terminating resistor and the one-turn primary are not supplied
- 2) Pin 3: Normally for mechanical support only but will be used on center tapped designs

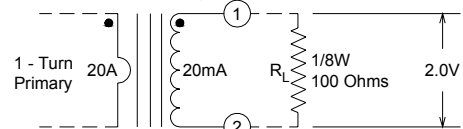

Regional Locations - Design, Manufacturing, Sales & Marketing
Talema Group Regional Offices
North America
**United States
(Sales & Marketing)**

Talema Group, LLC
 PO Box 935
 900 Innovation Drive
 Suite 120, Rolla
 Missouri 65402
 Tel: +1 573-303-3675
 E-Mail:
sales@talemagroup.com
 Web: www.talema.com

Asia
**India
(Design, Manufacturing, Sales & Marketing)**

Administrative Office
Talema Electronic India Private Limited
 Door No. 221, 1st and 2nd Floor
 KJ Plaza, Opp.to Vidya Mandir School
 Meyanoor Main Road
 Salem - 636 004 Tamil Nadu INDIA
 Tel: +91 427 - 243 3100
 Fax: +91 427 - 243 3109
 E-Mail: talema@talemaindia.net
 Web: www.talema.com

Factory Premises
Talema Electronic India Private Limited
 Plot Nos. 30, 31 Electrical and Electronic
 Industrial Estate
 Suramangalam
 Salem - 636 005 Tamil Nadu INDIA
 Tel: +91 427 - 243 3000
 E-Mail: talema@talemaindia.net
 Web: www.talema.com

Europe
**Germany
(Design, Sales & Marketing)**

Talema Elektronik GmbH
 Sembdnerstr. 5
 82110 Germering
 Tel: +49 89 - 841 00 - 0
 Fax: +49 89 - 841 00 25
 E-Mail: info@talema.de
 Web: www.talema.com

**Ireland
(Design, Sales & Marketing)**

Nuvotem TEO
 Units W & X, Gweedore Business Park
 Derrybeg, Letterkenny, Co. Donegal
 Tel: +353 (0) 74 95 48666
 Fax: +353 (0) 74 95 48139
 E-Mail: info@nuvotem.com
 Web: www.nuvotem.com

**Czech Republic
(Design, Manufacturing, Sales & Marketing)**

NT Magnetics s.r.o.
 Chebská 27
 322 00 Plzeň
 Tel: +420 377 - 338 351
 Fax: +420 377 - 338 350
 E-Mail: talema@talema.cz
 Web: www.ntmagnetics.cz

Locations of Talema Group Regional Offices
