

unit: MM \pm 0.5

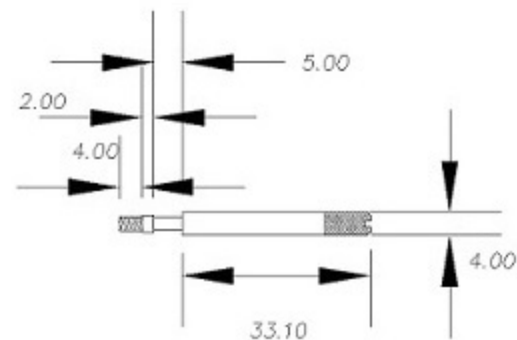

Thumbscrew H07-DAR

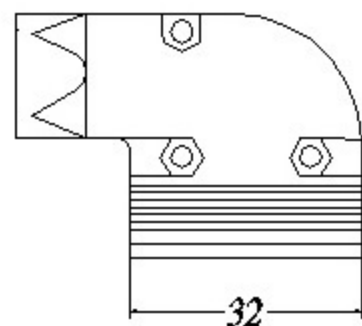
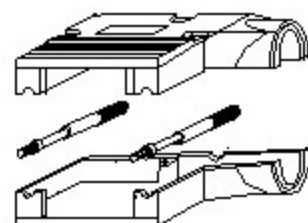
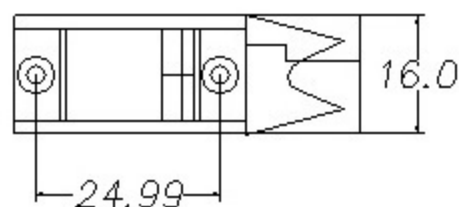

For D-sub

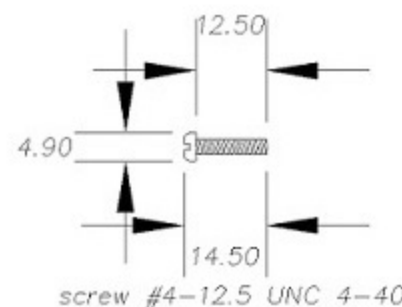

A: for cable dia. 6, 7.5, 9, 11

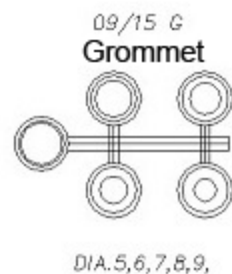

DIA. 5, 6, 7, 8, 9,

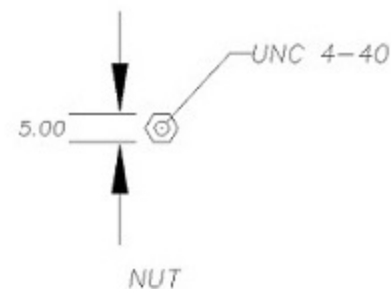
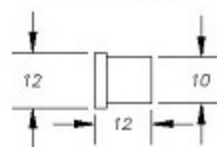

NUT

PART No.	Description
YD09DR	Thumbscrew +Screw #4-12.5 + Nut
YD09DRG	Thumbscrew + Screw #4-12.5 + Nut + Grommet 09/15

Shallin Electronics Co., Ltd.

Product : D-SUB HG0D

Material : Zinc alloy

Finished : Nickel plated