

10W, wide input, isolated & regulated dual/
single output, DIP package, DC-DC converter

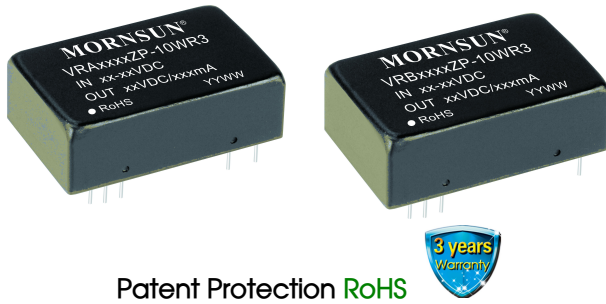

Patent Protection RoHS

FEATURES

- Wide input voltage range (2:1)
- High efficiency up to 88%
- No-load power consumption as low as 0.11W
- Isolation voltage : 1.5K VDC
- Operating temperature range: -40°C to +85°C
- Input under-voltage protection, output short circuit, over-current, over-voltage protection
- Meet CISPR32/EN55032 CLASS A without external components
- International standard pin-out

VRA_ZP-10WR3 & VRB_ZP-10WR3 series products are of 10W output power, wide range of voltage input of 9-18VDC, 18-36VDC, 36-75VDC isolation voltage of 1500VDC, input under-voltage protection, output over-voltage, over-current, short circuit protection and EMI meets CISPR32/EN55032 CLASS A without external components; these products are widely used in fields such as industrial control, electric power, instruments and communication.

Selection Guide

Certification	Part No.	Input Voltage (VDC)		Output		Efficiency ^② (%M in./Typ.) @ Full Load	Max. Capacitive Load ^③ (μF)
		Nominal (Range)	Max. ^①	Output Voltage (VDC)	Output Current (mA) (Max./Min.)		
-	VRA1205ZP-10WR3	12 (9-18)	20	±5	±1000/0	81/83	1000
	VRA1212ZP-10WR3			±12	±416/0	85/87	470
	VRA1215ZP-10WR3			±15	±333/0	85/87	330
	VRB1212ZP-10WR3			12	833/0	85/87	470
	VRB1215ZP-10WR3			15	667/0	85/87	330
	VRB1224ZP-10WR3			24	416/0	86/88	100
	VRA2405ZP-10WR3	24 (18-36)	40	±5	±1000/0	81/83	1000
	VRA2412ZP-10WR3			±12	±416/0	85/87	470
	VRA2415ZP-10WR3			±15	±333/0	85/87	330
	VRB2412ZP-10WR3			12	833/0	85/87	470
	VRB2415ZP-10WR3			15	667/0	85/87	330
	VRB2424ZP-10WR3			24	416/0	86/88	100
	VRA4805ZP-10WR3	48 (36-75)	80	±5	±1000/0	81/83	1000
	VRA4812ZP-10WR3			±12	±416/0	85/87	470
	VRA4815ZP-10WR3			±15	±333/0	85/87	330
	VRB4812ZP-10WR3			12	833/0	85/87	470
	VRB4815ZP-10WR3			15	667/0	85/87	330
	VRB4824ZP-10WR3			24	416/0	86/88	100

Notes:

- ① Absolute maximum rating without damage on the converter, but it isn't recommended;
- ② Efficiency is measured in nominal input voltage and rated output load;
- ③ The capacitive loads of positive and negative outputs are identical.

Input Specifications

Item	Operating Conditions	Min.	Typ.	Max.	Unit
Input Current (full load / no-load)	12VDC input, nominal input voltage	--	980/9	1028/15	mA
	24VDC input, nominal input voltage	--	490/5	515/12	
	48VDC input, nominal input voltage	--	245/4	258/8	
Reflected Ripple Current	12VDC input	--	50	--	
	24VDC input	--	40	--	
	48VDC input	--	30	--	

Surge Voltage (1sec. max.)	12VDC input	-0.7	--	25	VDC
	24VDC input	-0.7	--	50	
	48VDC input	-0.7	--	100	
Starting Voltage	12VDC input	--	--	9	
	24VDC input	--	--	18	
	48VDC input	--	--	36	
Shutdown Voltage	12VDC input	5.5	6.5	--	
	24VDC input	12	15.5	--	
	48VDC input	25	30.5	--	
Input Filter		Pi filter			
Hot Plug		Unavailable			
Ctrl*	Module switch on	Ctrl suspended or connected to TTL high level (3.5-12VDC)			
	Module switch off	Ctrl pin connected to GND or low level (0-1.2VDC)			
	Input current when switched off	--	6	10	mA

Note: *The voltage of Ctrl pin is relative to input pin GND.

Output Specifications

Item	Operating Conditions	Min.	Typ.	Max.	Unit	
Output Voltage Accuracy ^①	0%-100% load	Positive output	--	±0.5	±2	%
		Negative output	--	±1	±3	
Line Regulation	Full load, the input voltage is from low voltage to high voltage	Positive output	--	±0.2	±0.5	
		Negative output	--	±0.5	±1	
Load Regulation ^②	5%-100% load	Positive output	--	±0.5	±1	
		Negative output	--	±0.5	±1.5	
Cross Regulation	Dual output, main circuit with 50% load, auxiliary circuit with 25%-100% load	--	--	±5		
Transient Recovery Time	25% load step change, Nominal input voltage	--	300	500	μs	
Transient Response Deviation		--	±3	±5	%	
Temperature Coefficient	Full load	--	--	±0.03	%/°C	
Ripple & Noise ^③	20MHz bandwidth, 5%-100% load	--	40	100	mV p-p	
Over-voltage Protection	Input voltage range	110	--	160	%Vo	
Over-current Protection		110	140	190	%Io	
Short circuit Protection		Continuous, self-recovery				

Note:
 ① At 0%~5% load, the Max. output voltage accuracy of ±5VDC output converter is ±5%;
 ② When testing from 0% to 100% load working conditions, load regulation index of ±5%;
 ③ 0%-5% load ripple & noise is no more than 5%Vo. Ripple and noise are measured by "parallel cable" method, please see DC-DC Converter Application Notes for specific operation.

General Specifications

Item	Operating Conditions	Min.	Typ.	Max.	Unit
Isolation Voltage	Input-output, with the test time of 1 minute and the leak current lower than 1mA	1500	--	--	VDC
Insulation Resistance	Input-output, insulation voltage 500VDC	1000	--	--	MΩ
Isolation Capacitance	Input-output, 100KHz/0.1V	--	2000	--	pF
Operating Temperature	see Fig. 1	-40	--	+85	°C
Storage Temperature		-55	--	+125	
Storage Humidity	Non-condensing	5	--	95	%RH
Pin Welding Resistance Temperature	Welding spot is 1.5mm away from the casing, 10 seconds	--	--	+300	°C
Vibration		10-55Hz, 10G, 30 Min. along X, Y and Z			

Switching Frequency *	PWM mode	--	350	--	KHz
MTBF	MIL-HDBK-217F@25°C	1000	--	--	K hours

Note: *This series of products using reduced frequency technology, the switching frequency is test value of full load, When the load is reduced to below 50%, the switching frequency decreases with decreasing load.

Physical Specifications

Casing Material	Aluminum alloy
Package Dimensions	32.00*20.00*10.80mm
Weight	14g(Typ.)
Cooling Method	Free air convection

EMC Specifications

EMI	CE	CISPR32/EN55032	CLASS A (Bare component)/ CLASS B (see Fig.3-② for recommended circuit)
	RE	CISPR32/EN55032	CLASS A (Bare component)/ CLASS B (see Fig.3-② for recommended circuit)
EMS	ESD	IEC/EN61000-4-2	Contact ±4KV perf. Criteria B
	RS	IEC/EN61000-4-3	10V/m perf. Criteria A
	EFT	IEC/EN61000-4-4	±2KV (see Fig.3-① for recommended circuit) perf. Criteria B
	Surge	IEC/EN61000-4-5	line to line ±2KV (see Fig.3-① for recommended circuit) perf. Criteria B
	CS	IEC/EN61000-4-6	10 Vr.m.s perf. Criteria A
	Immunities of voltage dip, drop and short interruption	IEC/EN61000-4-29	0%, 70% perf. Criteria B

Product Characteristic Curve

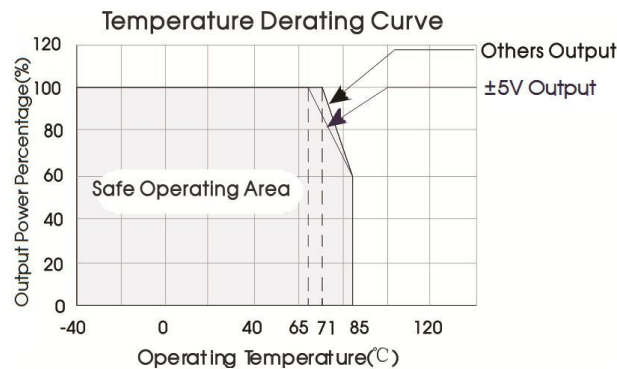
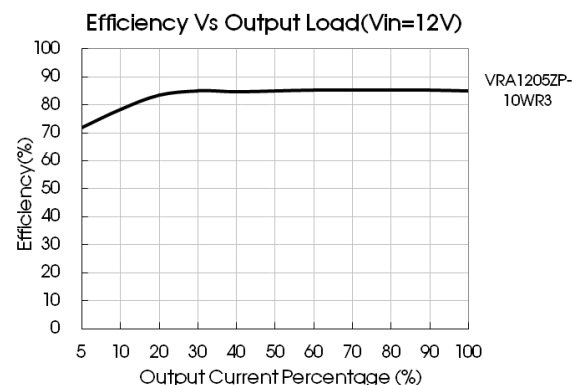
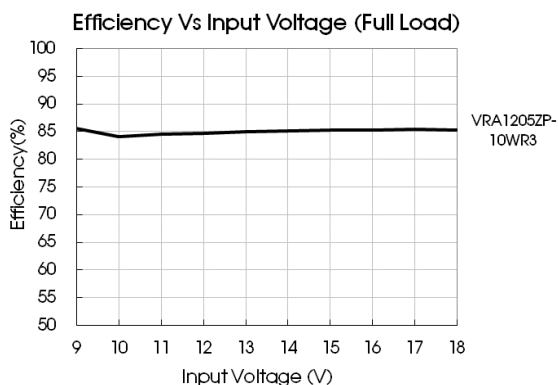
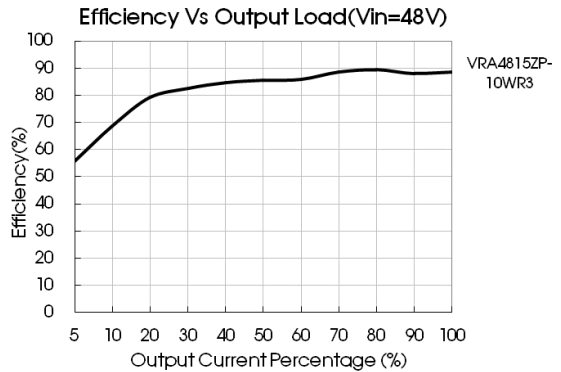
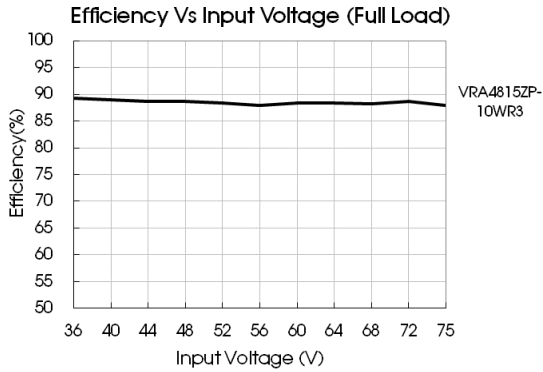
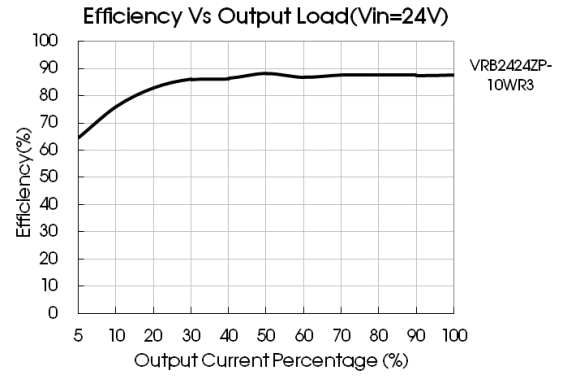
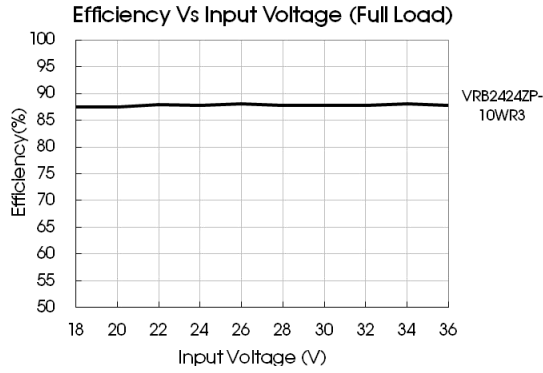

Fig. 1





Design Reference

1. Typical application

All the DC/DC converters of this series are tested according to the recommended circuit (see Fig. 2) before delivery. If it is required to further reduce input and output ripple, properly increase the input & output of additional capacitors C_{in} and C_{out} or select capacitors of low equivalent impedance provided that the capacitance is no larger than the max. capacitive load of the product.

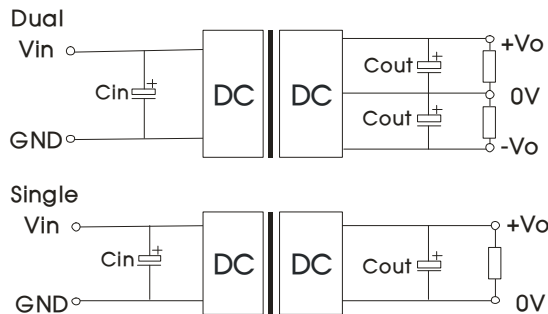

Fig. 2

Vin(VDC)	Cin	Cout
12/24	100 μ F	10 μ F
48	10 μ F ~47 μ F	10 μ F

2. EMC solution-recommended circuit

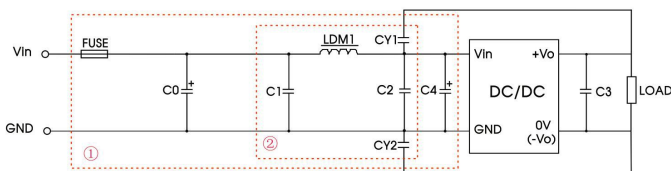

Fig. 3

Notes: Part ① in the Fig. 3 is used for EMC test and part ② for EMI filtering; selected based on needs.

Parameter description:

Model	Vin:12V	Vin:24V	Vin:48V
FUSE	Choose according to actual input current		
C0, C4	470 μ F/35V	330 μ F/50V	330 μ F/100V
C1, C2	10 μ F/50V		10 μ F/100V
C3	Refer to the Cout in Fig.2		
LDM1	10 μ H		
CY1, CY2	1nF/2KV		

3. The product does not support output in parallel with power per liter

4. For more information please find the application notes on www.mornsun-power.com

Dimensions and Recommended Layout

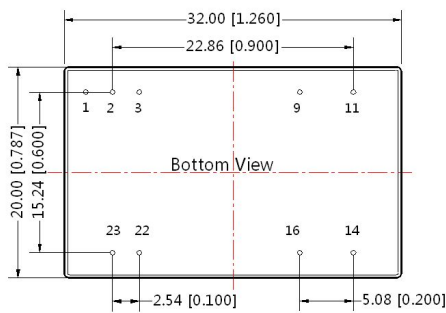
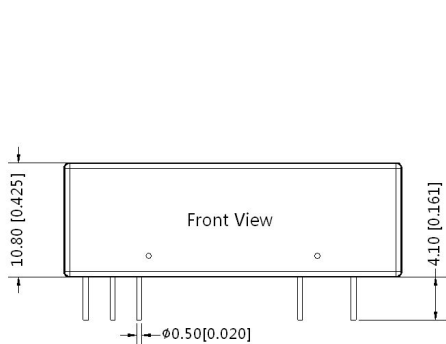

Note:
Unit :mm[inch]
Pin diameter tolerances : $\pm 0.10[\pm 0.004]$
General tolerances: $\pm 0.50[\pm 0.020]$

THIRD ANGLE PROJECTION

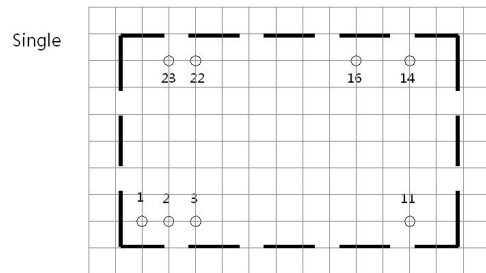
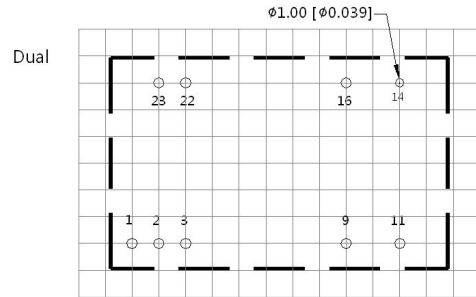

Note:Grid 2.54*2.54mm

Pin-Out		
Pin	Single	Dual
1	Ctrl	Ctrl
2,3	GND	GND
9	No Pin	0V
11	NC	-Vo
14	+Vo	+Vo
16	0V	0V
22,23	Vin	Vin

NC: Pin to be isolated from circuit

Notes:

1. Packing information please refer to Product Packing Information which can be downloaded from www.mornsun-power.com. Packing bag number: 58210008;
2. The maximum capacitive load offered were tested at input voltage range and full load;
3. Unless otherwise specified, parameters in this datasheet were measured under the conditions of $T_a=25^\circ\text{C}$, humidity<75%RH with nominal input voltage and rated output load;
4. All index testing methods in this datasheet are based on Company's corporate standards;
5. We can provide product customization service, please contact our technicians directly for specific information;
6. Products are related to laws and regulations: see "Features" and "EMC";
7. Our products shall be classified according to ISO14001 and related environmental laws and regulations, and shall be handled by qualified units.

Mornsun Guangzhou Science & Technology Co., Ltd.

Address: No. 5, Kehui St. 1, Kehui Development Center, Science Ave., Guangzhou Science City, Luogang District, Guangzhou, P. R. China
Tel: 86-20-38601850-8801 Fax: 86-20-38601272 E-mail: info@mornsun.cn