

TOSHIBA Photocoupler GaAlAs IRED + Photo IC

TLP351

Inverter for Air Conditioner
IGBT/Power MOS FET Gate Drive
Industrial Inverter

The TOSHIBA TLP351 consists of a GaAlAs light emitting diode and an integrated photodetector.

This unit is 8-lead DIP package.

TLP351 is suitable for gate driving circuit of IGBT or power MOS FET.

Especially TLP351 is capable of "direct" gate drive of lower Power IGBTs.

- Peak output current: ± 0.6 A (max)
- Guaranteed performance over temperature: -40 to 100°C
- Supply current: 2 mA (max)
- Power supply voltage: 10 to 30 V
- Threshold input current : $I_F = 5$ mA (max)
- Switching time (t_{pLH}/t_{pHL}) : 700 ns (max)
- Common mode transient immunity: 10 kV/ μs
- Isolation voltage: 3750 Vrms
- Option(D4)

VDE Approved : DIN EN60747-5-2

Maximum Operating Insulation Voltage : 890V_{PK}

Highest Permissible Over Voltage : 4000V_{PK}

(Note):When a EN60747-5-2 approved type is needed,
Please designate "Option(D4)"

Unit: mm

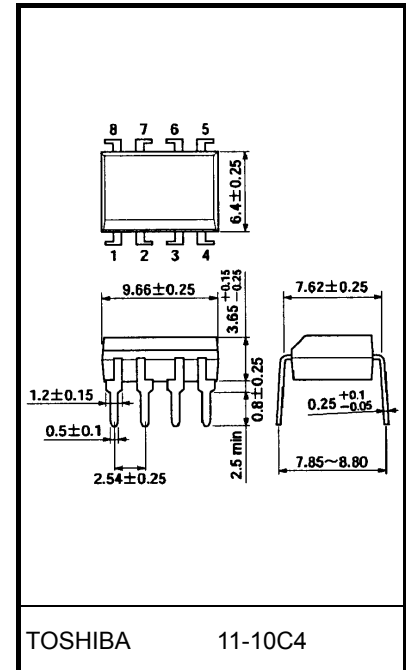

Weight: 0.54 g (typ.)

Truth Table

Input	LED	Tr1	Tr2	Output
H	ON	ON	OFF	H
L	OFF	OFF	ON	L

Pin Configuration (top view)

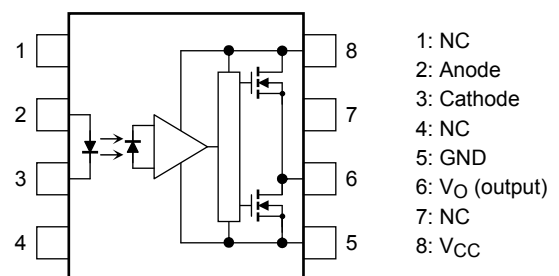

Schematic

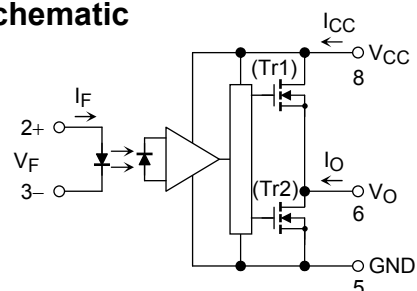

A 0.1 μF bypass capacitor must be connected between pin 8 and 5.

Absolute Maximum Ratings (Ta = 25°C)

Characteristics		Symbol	Rating	Unit
LED	Forward current	I _F	20	mA
	Forward current derating (Ta ≥ 85°C)	ΔI _F /ΔTa	-0.54	mA/°C
	Peak transient forward current (Note 1)	I _{FP}	1	A
	Reverse voltage	V _R	5	V
	Junction temperature	T _j	125	°C
Detector	"H" peak output current (Note 2)	I _{OPH}	-0.6	A
	"L" peak output current (Note 2)	I _{OPL}	0.6	A
	Output voltage	V _O	35	V
	Supply voltage	V _{CC}	35	V
	Junction temperature	T _j	125	°C
Operating frequency (Note 3)	f	25	kHz	
Storage temperature range	T _{stg}	-55 to 125	°C	
Operating temperature range	T _{opr}	-40 to 100	°C	
Lead soldering temperature (10 s) (Note 4)	T _{sol}	260	°C	
Isolation voltage (AC, 1 minute, R.H. ≤ 60%) (Note 5)	BV _S	3750	V _{rms}	

Note: Using continuously under heavy loads (e.g. the application of high temperature/current/voltage and the significant change in temperature, etc.) may cause this product to decrease in the reliability significantly even if the operating conditions (i.e. operating temperature/current/voltage, etc.) are within the absolute maximum ratings.

Please design the appropriate reliability upon reviewing the Toshiba Semiconductor Reliability Handbook ("Handling Precautions"/"Derating Concept and Methods") and individual reliability data (i.e. reliability test report and estimated failure rate, etc).

Note 1: Pulse width P_W ≤ 1 μs, 300 pps

Note 2: Exponential waveform pulse width P_W ≤ 10 μs, f ≤ 15 kHz

Note 3: Exponential waveform I_{OPH} ≤ -0.4 A (≤ 2.0 μs), I_{OPL} ≤ +0.4 A (≤ 2.0 μs), Ta = 100°C

Note 4: It is 2 mm or more from a lead root.

Note 5: Device considered a two terminal device: pins 1, 2, 3 and 4 shorted together, and pins 5, 6, 7 and 8 shorted together.

Note 6: A ceramic capacitor(0.1 μF) should be connected from pin 8 to pin 5 to stabilize the operation of the high gain linear amplifier. Failure to provide the bypassing may impair the switching property.
The total lead length between capacitor and coupler should not exceed 1 cm.

Recommended Operating Conditions

Characteristics	Symbol	Min	Typ.	Max	Unit
Input current, ON (Note 7)	I _F (ON)	7.5	—	10	mA
Input voltage, OFF	V _F (OFF)	0	—	0.8	V
Supply voltage	V _{CC}	10	—	30	V
Peak output current	I _{OPH} /I _{OPL}	—	—	±0.2	A
Operating temperature	T _{opr}	-40	—	100	°C

Note: Recommended operating conditions are given as a design guideline to obtain expected performance of the device. Additionally, each item is an independent guideline respectively. In developing designs using this product, please confirm specified characteristics shown in this document.

Note 7: Input signal rise time (fall time) < 0.5 μs.

Electrical Characteristics (Ta = -40 to 100°C, unless otherwise specified)

Characteristics		Symbol	Test Circuit	Test Condition	Min	Typ.*	Max	Unit	
Forward voltage		V _F	—	I _F = 5 mA, Ta = 25°C	—	1.55	1.70	V	
Temperature coefficient of forward voltage		ΔV _F /ΔTa	—	I _F = 5 mA	—	-2.0	—	mV/°C	
Input reverse current		I _R	—	V _R = 5 V, Ta = 25°C	—	—	10	μA	
Input capacitance		C _T	—	V = 0, f = 1 MHz, Ta = 25°C	—	45	—	pF	
Output current (Note 8)	"H" Level	I _{OPH1}	1	V _{CC} = 15 V I _F = 5 mA	V ₈₋₆ = 4 V	-0.2	-0.4	—	A
		I _{OPH2}			V ₈₋₆ = 10 V	-0.4	-0.67		
	"L" Level	I _{OPL1}	2	V _{CC} = 15 V I _F = 0 mA	V ₆₋₅ = 2 V	0.2	0.35	—	
		I _{OPL2}			V ₆₋₅ = 10 V	0.4	0.63	—	
Output voltage	"H" Level	V _{OH}	3	V _{CC} = 10 V	I _O = -100 mA, I _F = 5 mA	6.0	8.5	—	V
	"L" Level	V _{OL}			4	I _O = 100 mA, V _F = 0.8 V	—	0.4	
Supply current	"H" Level	I _{CCH}	5	V _{CC} = 10 to 30 V V _O open	I _F = 10 mA	—	1.4	2.0	mA
	"L" Level	I _{CCL}			6	I _F = 0 mA	—	1.3	
Threshold input current	L → H	I _{FLH}	—	V _{CC} = 15 V, V _O > 1 V	—	2.5	5	mA	
Threshold input voltage	H → L	V _{FHL}	—	V _{CC} = 15 V, V _O < 1 V	0.8	—	—	V	
Supply voltage		V _{CC}	—	—	10	—	30	V	

*: All typical values are at Ta = 25°C

Note 8: Duration of I_O time ≤ 50 μs

Note 9: This product is more sensitive than the conventional product to static electricity (ESD) because of a lowest power consumption design.

General precaution to static electricity (ESD) is necessary for handling this component.

Isolation Characteristics (Ta = 25°C)

Characteristic	Symbol	Test Conditions	Min.	Typ.	Max.	Unit
Capacitance input to output	C _S	V = 0, f = 1MHz (Note5)	—	1.0	—	pF
Isolation resistance	R _S	V _S = 500 V, Ta = 25°C, R.H. ≤ 60% (Note5)	1×10 ¹²	10 ¹⁴	—	Ω
Isolation voltage	BV _S	AC, 1 minute	3750	—	—	V _{rms}
		AC, 1 second, in oil	—	10000	—	
		DC, 1 minute, in oil	—	10000	—	V _{dc}

Switching Characteristics (Ta = -40 to 100°C, unless otherwise specified)

Characteristics	Symbol	Test Circuit	Test Condition	Min	Typ.*	Max	Unit	
Propagation delay time	L → H	7	V _{CC} = 30 V R _g = 47 Ω C _g = 3 nF	I _F = 0 → 5 mA	100	—	700	ns
	H → L			I _F = 5 → 0 mA	100	—	700	
Propagation delay difference between any two parts or channels	PDD t _{pHL} - t _{pLH}	7	V _{CC} = 30 V, R _g = 47 Ω, C _g = 3 nF	-500	—	500	ns	
Output rise time (10-90%)	t _r	7	V _{CC} = 30 V R _g = 47 Ω C _g = 3 nF	I _F = 0 → 5 mA	—	50	—	ns
Output fall time (90-10%)	t _f			I _F = 5 → 0 mA	—	50	—	
Common mode transient immunity at high level output	CM _H	8	V _{CM} = 1000 V _{p-p} Ta = 25°C V _{CC} = 30 V	I _F = 5 mA V _O (min) = 26 V	-10000	—	—	V/μs
Common mode transient immunity at low level output	CM _L			I _F = 0 mA V _O (max) = 1 V	10000	—	—	

*: All typical values are at Ta = 25°C

Test Circuit 1: I_{OPH}

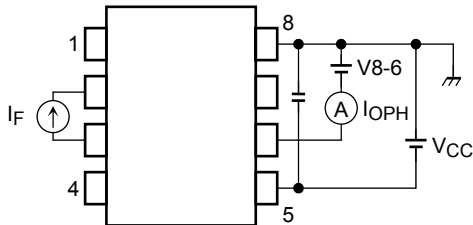

Test Circuit 2: I_{OPL}

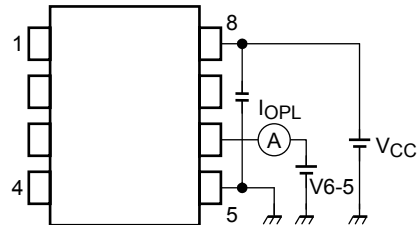

Test Circuit 3: V_{OH}

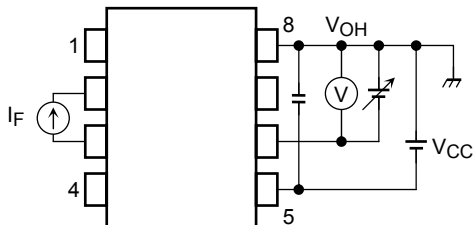

Test Circuit 4: V_{OL}

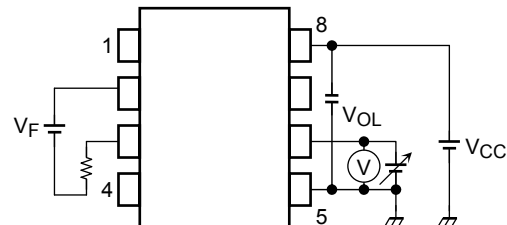

Test Circuit 5: I_{CCH}

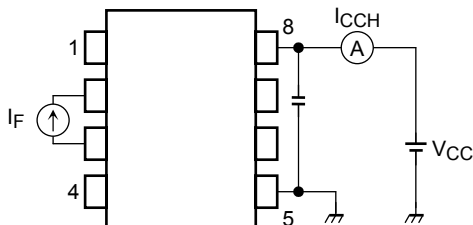

Test Circuit 6: I_{CCL}

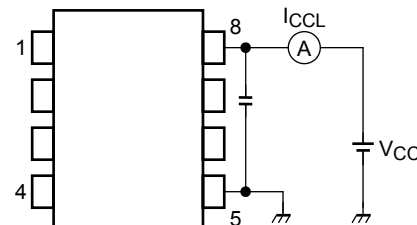

Test Circuit 7: t_{pLH} , t_{pHL} , t_r , t_f , PDD

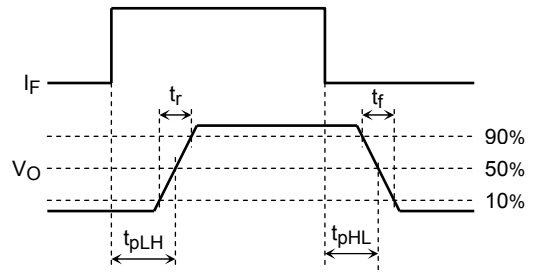
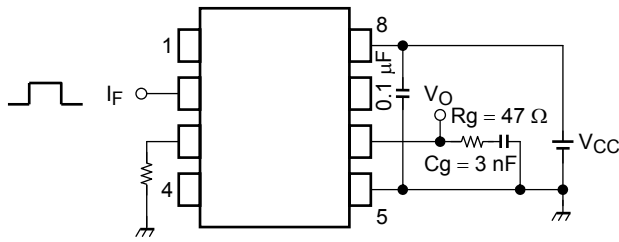

Test Circuit 8: CM_H , CM_L

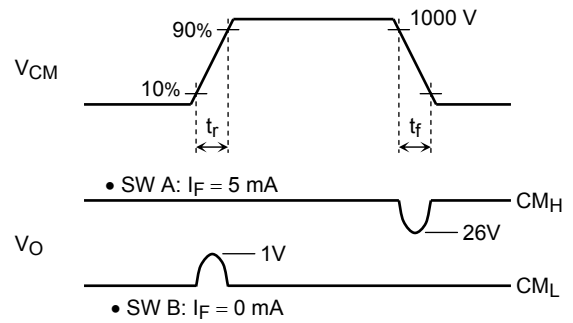
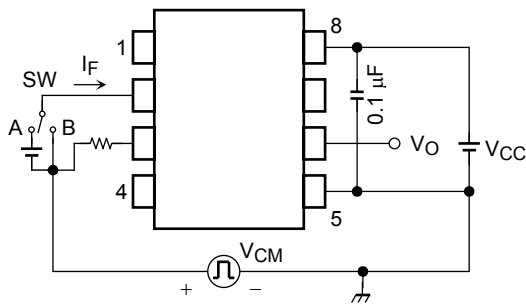

$$CM_L = \frac{800 \text{ V}}{t_f (\mu\text{s})}$$

$$CM_H = \frac{800 \text{ V}}{t_r (\mu\text{s})}$$

CM_L (CM_H) is the maximum rate of rise (fall) of the common mode voltage that can be sustained with the output voltage in the low (high) state.

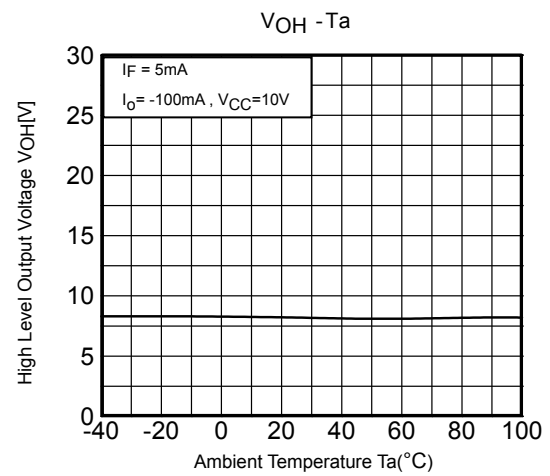
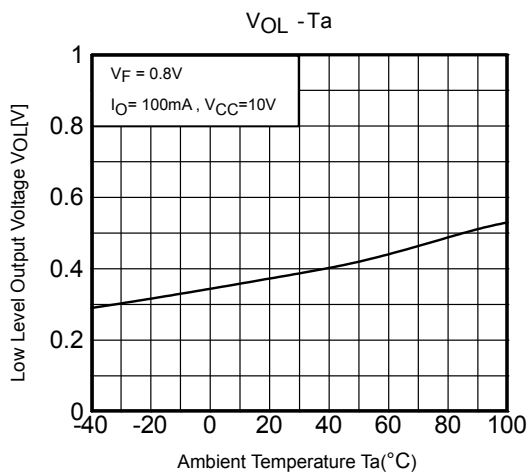
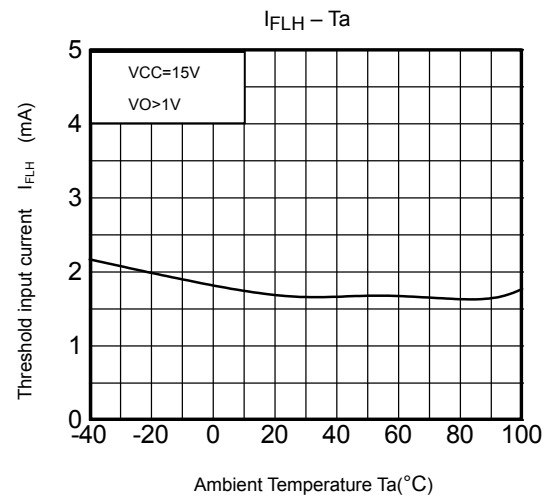
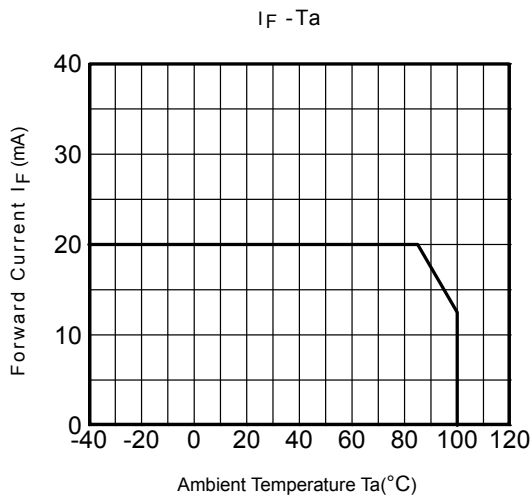
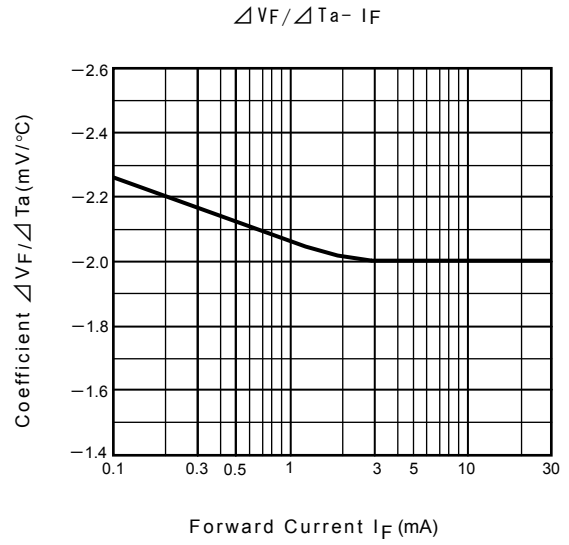
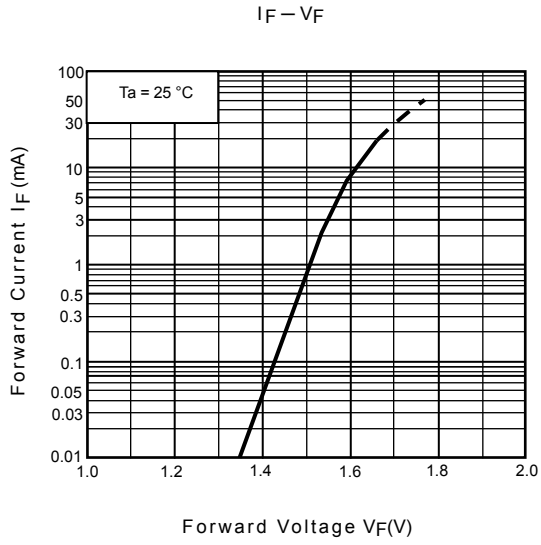

*: The above graphs show typical characteristics.

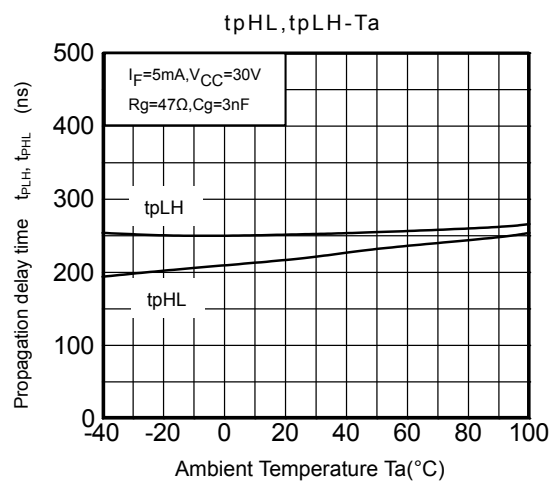
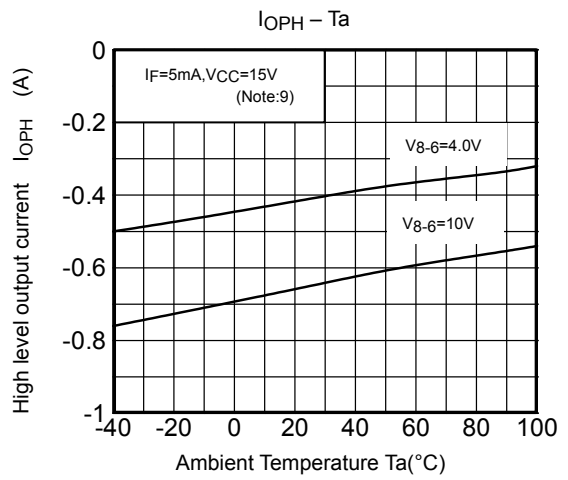
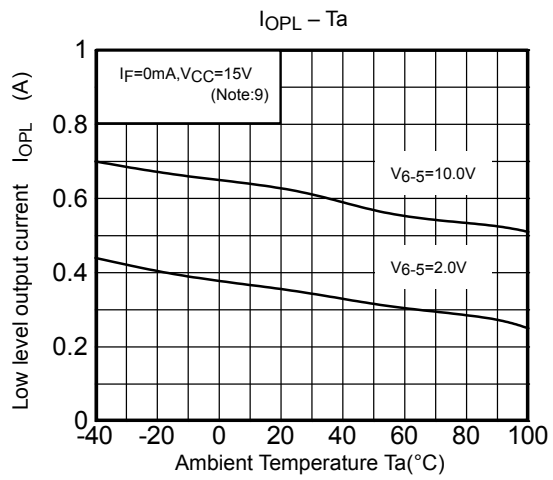
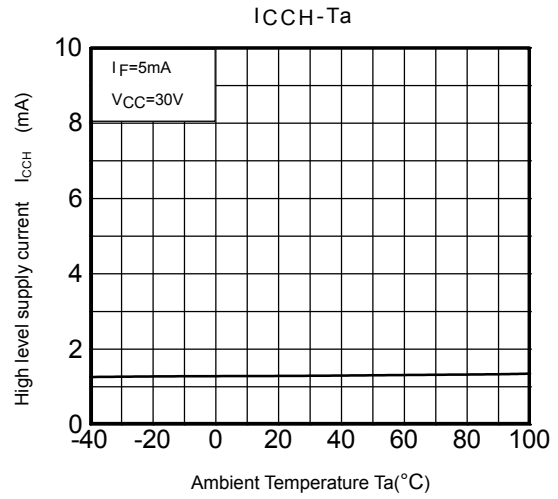
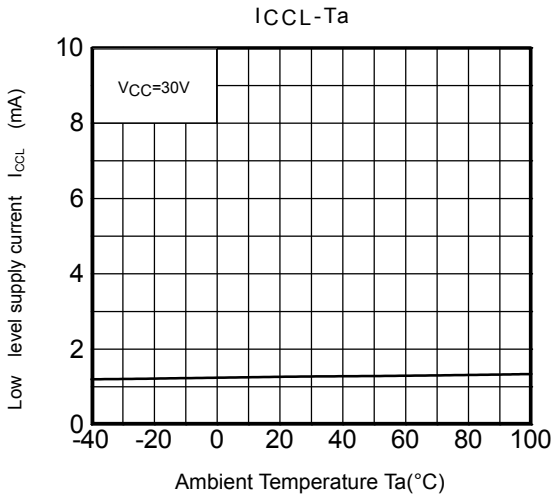

*: The above graphs show typical characteristics.

RESTRICTIONS ON PRODUCT USE

20070701-EN

- The information contained herein is subject to change without notice.
- TOSHIBA is continually working to improve the quality and reliability of its products. Nevertheless, semiconductor devices in general can malfunction or fail due to their inherent electrical sensitivity and vulnerability to physical stress. It is the responsibility of the buyer, when utilizing TOSHIBA products, to comply with the standards of safety in making a safe design for the entire system, and to avoid situations in which a malfunction or failure of such TOSHIBA products could cause loss of human life, bodily injury or damage to property.
In developing your designs, please ensure that TOSHIBA products are used within specified operating ranges as set forth in the most recent TOSHIBA products specifications. Also, please keep in mind the precautions and conditions set forth in the "Handling Guide for Semiconductor Devices," or "TOSHIBA Semiconductor Reliability Handbook" etc.
- The TOSHIBA products listed in this document are intended for usage in general electronics applications (computer, personal equipment, office equipment, measuring equipment, industrial robotics, domestic appliances, etc.). These TOSHIBA products are neither intended nor warranted for usage in equipment that requires extraordinarily high quality and/or reliability or a malfunction or failure of which may cause loss of human life or bodily injury ("Unintended Usage"). Unintended Usage include atomic energy control instruments, airplane or spaceship instruments, transportation instruments, traffic signal instruments, combustion control instruments, medical instruments, all types of safety devices, etc.. Unintended Usage of TOSHIBA products listed in this document shall be made at the customer's own risk.
- The products described in this document shall not be used or embedded to any downstream products of which manufacture, use and/or sale are prohibited under any applicable laws and regulations.
- The information contained herein is presented only as a guide for the applications of our products. No responsibility is assumed by TOSHIBA for any infringements of patents or other rights of the third parties which may result from its use. No license is granted by implication or otherwise under any patents or other rights of TOSHIBA or the third parties.
- GaAs(Gallium Arsenide) is used in this product. The dust or vapor is harmful to the human body. Do not break, cut, crush or dissolve chemically.
- Please contact your sales representative for product-by-product details in this document regarding RoHS compatibility. Please use these products in this document in compliance with all applicable laws and regulations that regulate the inclusion or use of controlled substances. Toshiba assumes no liability for damage or losses occurring as a result of noncompliance with applicable laws and regulations.