

R13-285

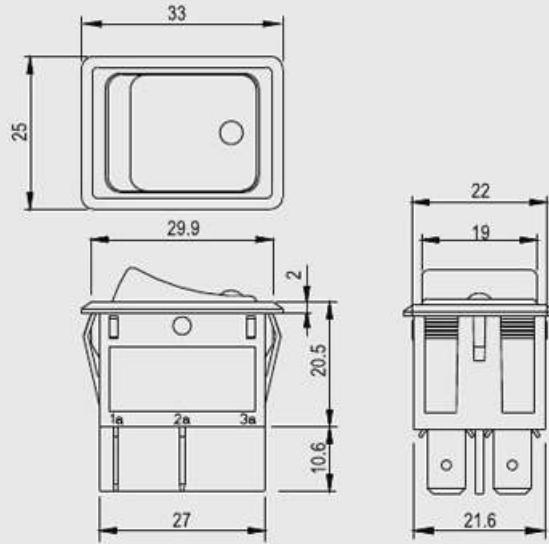

IP65



Rating	10(8)A 250V AC 10A 60V DC
Contact resistance	50mΩ Max
Insulation resistance	DC 500V 100MΩ Min
Dielectric strength	AC 1500V 1 minute
Cut-out	



Terminal Spacing	X	Y
0.75-1.25	30.2±0.1	22.2±0.1
1.25-2.0	30.4±0.1	22.2±0.1
2.0-4.0	30.8±0.1	22.2±0.1

Cut-out for X8 ROCKER

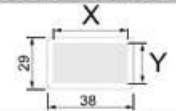

Terminal Spacing	X	Y
0.75-1.25	30.2±0.1	22.2±0.1
1.25-2.0	30.4±0.1	22.2±0.1
2.0-4.0	30.8±0.1	22.2±0.1

FEATURES

- * MATERIAL: Frame is nylon (UL flame: 94V-2). Terminals are silver plated brass.
- * Illuminated actuators are molded in PC, available with red, amber, green, blue and white colors.
- * Snap-in mounting, easy to install switch into panel.
- * Red lighted when OFF, green lighted when ON.
- * Watertight by a rubber cover: R13-285A8, R13-285C8, R13-285A8L and R13-285C8L.
- * New design AC LED.

Ordering number instruction

R13-285 [] [] [] [] - [] [] [] [] - [] [] [] [] - [] [] [] []

FUNCTION

Illuminated / Different position (帶燈/動作特性不同)

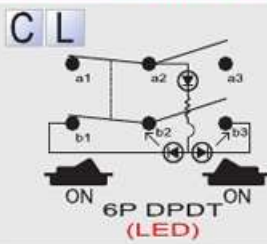
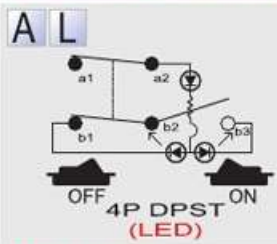

Watertight (防水)

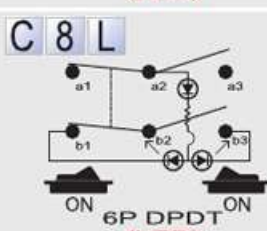
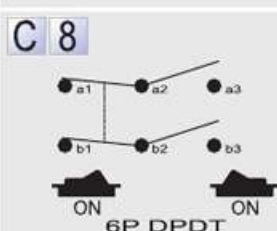
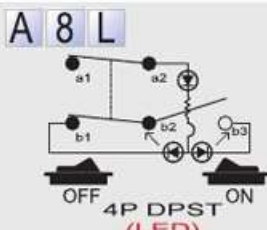
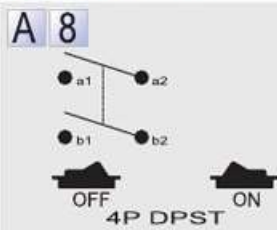

ROCKER

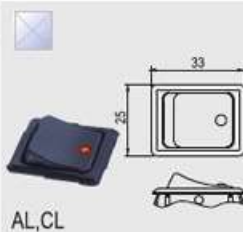

TERMINAL

0 1 .250" SQ

FRAME COLOR

ROCKER COLOR

LED COLOR(ON)

LED COLOR(OFF)

COLOR

A AMBER

B BLACK

G GREEN

U BLUE

C CLEAR

R RED

W WHITE

N NONE

VOLTAGE

4 125VAC(110VAC)

5 250VAC(220VAC)

IP65



R13-285A8L-01-5BNNM4

IP65



R13-285A8L-01-5BRRR4

IP65



R13-285A8L-2-01-5BRRR4