

Transient Voltage Suppressors (TVS) Data Sheet

Features

- Glass passivated junction
- Low zener impedance
- Excellent clamping capability
- 600W peak pulse power capability at 10/1000 μ s waveform, repetition rate (duty cycle): 0.01%
- Fast response time
- Typical I_R less than 1 μ A above 12V.
- High Temperature soldering guaranteed: 265 $^{\circ}$ C/10 seconds/.375", (9.5mm) lead length, 5lbs (2.3kg) tension
- Plastic package has underwriters laboratory flammability 94V-0
- Meets MSL level 1, per J-STD-020.
- Safety certification: UL: E244458



Mechanical Data

- Case: JEDEC DO-15 Moulded plastic
- Terminal: Axial leads, solderable per MIL-STD-750, Method 2026
- Polarity: Color band denotes cathode except bi-directional models
- Mounting Position: Any
- Weight: 0.42g

Applications

- I/O interface
- AC/DC power supply
- Low frequency signal transmission line (RS232, RS485, etc.)

Maximum Ratings and Characteristics

Ratings at 25 $^{\circ}$ C ambient temperature unless otherwise specified.

| Rating | Symbol | Value | Units |
|---|-----------------|-------------|----------------|
| Peak pulse power dissipation at 10/1000 μ s waveform (Note1, Fig.1) | P_{PPM} | Minimum 600 | Watts |
| Peak pulse current of at 10/1000 μ s waveform (Note 1, Fig.3) | I_{PPM} | See Table | Amps |
| Steady state power dissipation at $T_L=75^{\circ}$ C (Fig.5) | $P_{M(AV)}$ | 5.0 | Watts |
| Peak forward surge current, 8.3ms single half sine-wave superimposed on rated load, (JEDEC Method) (Note2, Fig.6) | I_{FSM} | 100 | Amps |
| Operating junction and Storage Temperature Range. | T_J, T_{STG} | -55 to +175 | $^{\circ}$ C |
| Typical thermal resistance junction to lead | $R_{\theta JL}$ | 20 | $^{\circ}$ C/W |
| Typical thermal resistance junction to ambient | $R_{\theta JA}$ | 75 | $^{\circ}$ C/W |

Notes: 1. Non-repetitive current pulse, per Fig.3 and derated above $T_A=25^{\circ}$ C per Fig.2.

2. 8.3ms single half sine-wave, or equivalent square wave, duty cycle=4 pulses per minutes maximum.

Dimensions (DO-204AC/DO-15)

|  | Symbol | Millimeters | | Inches | |
|---|--------|-------------|-------|--------|-------|
| | | Min. | Max. | Min. | Max. |
| | L | 25.40 | - | 1.000 | - |
| | T | 5.80 | 7.60 | 0.230 | 0.300 |
| | d | 2.60 | 3.60 | 0.104 | 0.140 |
| s | 0.71 | 0.86 | 0.028 | 0.034 | |

Electrical Characteristics (T_A=25°C)

| Part Number | | Reverse Stand-Off Voltage | Breakdown Voltage @I _T | Test Current | Maximum Clamping Voltage @I _{PP} | Peak Pulse Current | Reverse Leakage @V _{RWM} |
|----------------|---------------|---------------------------|-----------------------------------|---------------------|---|---------------------|-----------------------------------|
| Unidirectional | Bidirectional | V _{RWM} (V) | V _{BR} (V) | I _T (mA) | V _C (V) | I _{PP} (A) | I _R (μA) |
| P6KE6.8A | P6KE6.8CA | 5.80 | 6.45~7.14 | 10 | 10.5 | 58.1 | 1000 |
| P6KE7.5A | P6KE7.5CA | 6.40 | 7.13~7.88 | 10 | 11.3 | 54.0 | 500 |
| P6KE8.2A | P6KE8.2CA | 7.02 | 7.79~8.61 | 10 | 12.1 | 50.4 | 200 |
| P6KE9.1A | P6KE9.1CA | 7.78 | 8.65~9.55 | 1 | 13.4 | 45.5 | 50 |
| P6KE10A | P6KE10CA | 8.55 | 9.50~10.50 | 1 | 14.5 | 42.1 | 10 |
| P6KE11A | P6KE11CA | 9.40 | 10.50~11.60 | 1 | 15.6 | 39.1 | 5 |
| P6KE12A | P6KE12CA | 10.20 | 11.40~12.60 | 1 | 16.7 | 36.5 | 5 |
| P6KE13A | P6KE13CA | 11.10 | 12.40~13.70 | 1 | 18.2 | 33.5 | 1 |
| P6KE15A | P6KE15CA | 12.80 | 14.30~15.80 | 1 | 21.2 | 28.8 | 1 |
| P6KE16A | P6KE16CA | 13.60 | 15.20~16.80 | 1 | 22.5 | 27.1 | 1 |
| P6KE18A | P6KE18CA | 15.30 | 17.10~18.90 | 1 | 25.2 | 24.2 | 1 |
| P6KE20A | P6KE20CA | 17.10 | 19.00~21.00 | 1 | 27.7 | 22.0 | 1 |
| P6KE22A | P6KE22CA | 18.80 | 20.90~23.10 | 1 | 30.6 | 19.9 | 1 |
| P6KE24A | P6KE24CA | 20.50 | 22.80~25.20 | 1 | 33.2 | 18.4 | 1 |
| P6KE27A | P6KE27CA | 23.10 | 25.70~28.40 | 1 | 37.5 | 16.3 | 1 |
| P6KE30A | P6KE30CA | 25.60 | 28.50~31.50 | 1 | 41.4 | 14.7 | 1 |
| P6KE33A | P6KE33CA | 28.20 | 31.40~34.70 | 1 | 45.7 | 13.3 | 1 |
| P6KE36A | P6KE36CA | 30.80 | 34.20~37.80 | 1 | 49.9 | 12.2 | 1 |
| P6KE39A | P6KE39CA | 33.30 | 37.10~41.00 | 1 | 53.9 | 11.3 | 1 |
| P6KE43A | P6KE43CA | 36.80 | 40.90~45.20 | 1 | 59.3 | 10.3 | 1 |

Electrical Characteristics ($T_A=25^{\circ}\text{C}$)

| Part Number | | Reverse Stand-Off Voltage | Breakdown Voltage @ I_T | Test Current | Maximum Clamping Voltage @ I_{PP} | Peak Pulse Current | Reverse Leakage @ V_{RWM} |
|----------------|---------------|---------------------------|---------------------------|--------------|-------------------------------------|--------------------|-----------------------------|
| Unidirectional | Bidirectional | $V_{RWM}(V)$ | $V_{BR}(V)$ | $I_T(mA)$ | $V_C(V)$ | $I_{PP}(A)$ | $I_R(\mu A)$ |
| P6KE47A | P6KE47CA | 40.20 | 44.70~49.40 | 1 | 64.8 | 9.4 | 1 |
| P6KE51A | P6KE51CA | 43.60 | 48.50~53.60 | 1 | 70.1 | 8.7 | 1 |
| P6KE56A | P6KE56CA | 47.80 | 53.20~58.80 | 1 | 77.0 | 7.9 | 1 |
| P6KE62A | P6KE62CA | 53.00 | 58.90~65.10 | 1 | 85.0 | 7.2 | 1 |
| P6KE68A | P6KE68CA | 58.10 | 64.60~71.40 | 1 | 92.0 | 6.6 | 1 |
| P6KE75A | P6KE75CA | 64.10 | 71.30~78.80 | 1 | 103.0 | 5.9 | 1 |
| P6KE82A | P6KE82CA | 70.10 | 77.90~86.10 | 1 | 113.0 | 5.4 | 1 |
| P6KE91A | P6KE91CA | 77.80 | 86.50~95.50 | 1 | 125.0 | 4.9 | 1 |
| P6KE100A | P6KE100CA | 85.50 | 95.00~105.00 | 1 | 137.0 | 4.5 | 1 |
| P6KE110A | P6KE110CA | 94.00 | 105.00~116.00 | 1 | 152.0 | 4.0 | 1 |
| P6KE120A | P6KE120CA | 102.00 | 114.00~126.00 | 1 | 165.0 | 3.7 | 1 |
| P6KE130A | P6KE130CA | 111.00 | 124.00~137.00 | 1 | 179.0 | 3.4 | 1 |
| P6KE150A | P6KE150CA | 128.00 | 143.00~158.00 | 1 | 207.0 | 2.9 | 1 |
| P6KE160A | P6KE160CA | 136.00 | 152.00~168.00 | 1 | 219.0 | 2.8 | 1 |
| P6KE170A | P6KE170CA | 145.00 | 162.00~179.00 | 1 | 234.0 | 2.6 | 1 |
| P6KE180A | P6KE180CA | 154.00 | 171.00~189.00 | 1 | 246.0 | 2.5 | 1 |
| P6KE200A | P6KE200CA | 171.00 | 190.00~210.00 | 1 | 274.0 | 2.2 | 1 |
| P6KE220A | P6KE220CA | 185.00 | 209.00~231.00 | 1 | 328.0 | 1.9 | 1 |
| P6KE250A | P6KE250CA | 214.00 | 237.00~263.00 | 1 | 344.0 | 1.8 | 1 |
| P6KE300A | P6KE300CA | 256.00 | 285.00~315.00 | 1 | 414.0 | 1.5 | 1 |
| P6KE350A | P6KE350CA | 300.00 | 332.00~368.00 | 1 | 482.0 | 1.3 | 1 |
| P6KE400A | P6KE400CA | 342.00 | 380.00~420.00 | 1 | 548.0 | 1.1 | 1 |
| P6KE440A | P6KE440CA | 376.00 | 418.00~462.00 | 1 | 602.0 | 1.04 | 1 |
| P6KE480A | P6KE480CA | 408.00 | 456.00~504.00 | 1 | 658.0 | 0.9 | 1 |
| P6KE510A | P6KE510CA | 434.00 | 485.00~535.00 | 1 | 698.0 | 0.9 | 1 |
| P6KE530A | P6KE530CA | 450.00 | 503.50~556.50 | 1 | 725.0 | 0.8 | 1 |
| P6KE540A | P6KE540CA | 459.00 | 513.00~567.00 | 1 | 740.0 | 0.8 | 1 |
| P6KE550A | P6KE550CA | 467.00 | 522.50~577.50 | 1 | 760.0 | 0.8 | 1 |
| P6KE600A | P6KE600CA | 512.00 | 570.00~630.00 | 1 | 828.0 | 0.75 | 1 |

Notes: For bidirectional type having V_{RWM} of 10V and less, the I_R limit is double.

Ratings and Characteristic Curves ($T_A=25^\circ\text{C}$ unless otherwise noted)

Figure 1. Peak Pulse Power Rating Curve

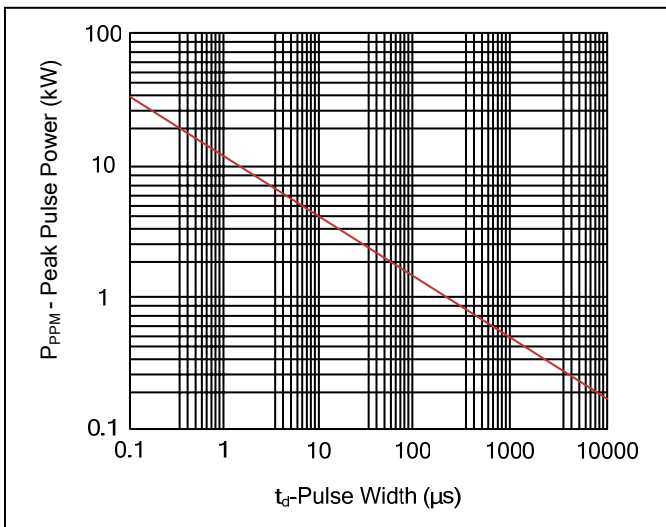

Figure 2. Pulse Derating Curve

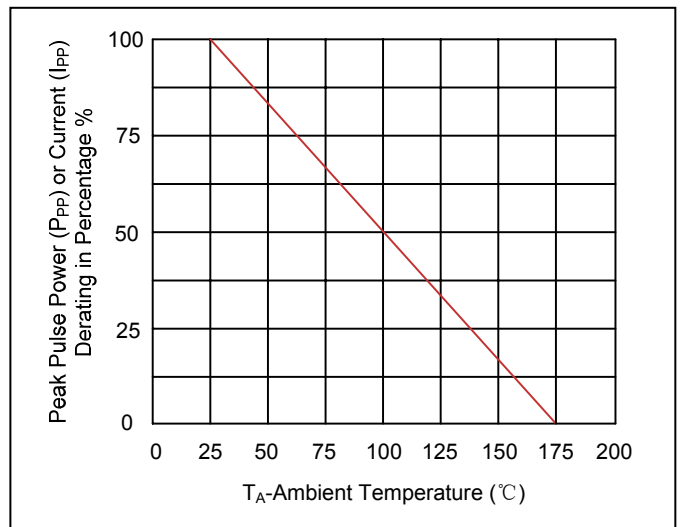

Figure 3. Pulse Waveform

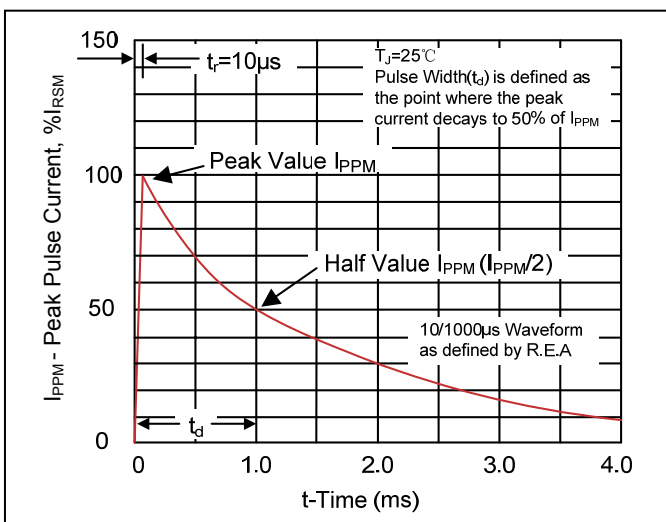

Figure 4. Typical Junction Capacitance

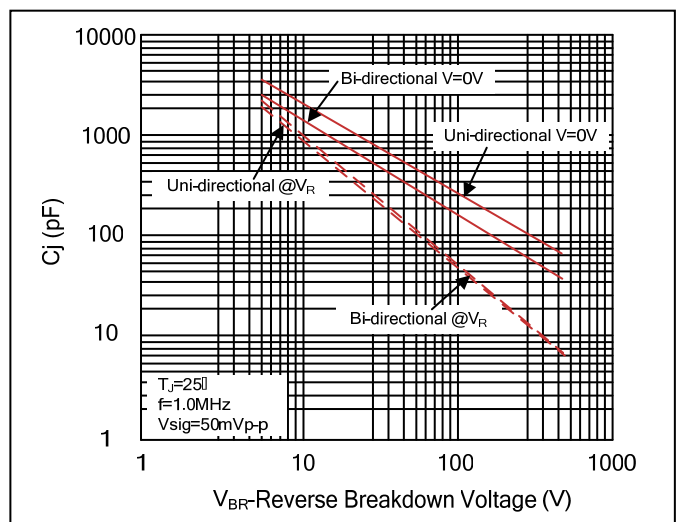

Figure 5. Steady State Power Dissipation Derating Curve

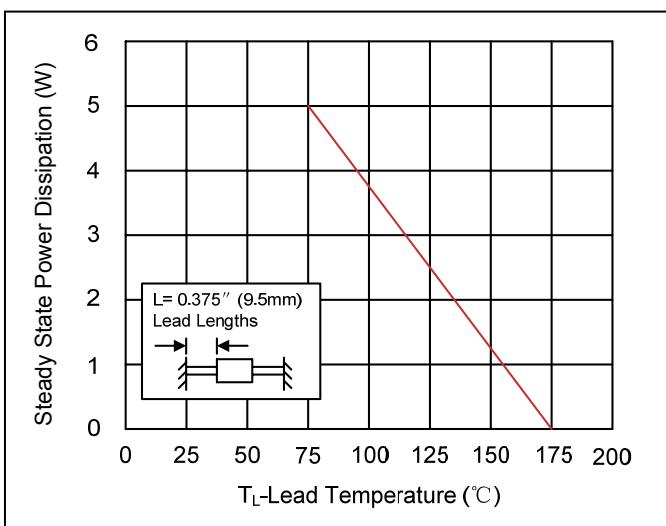
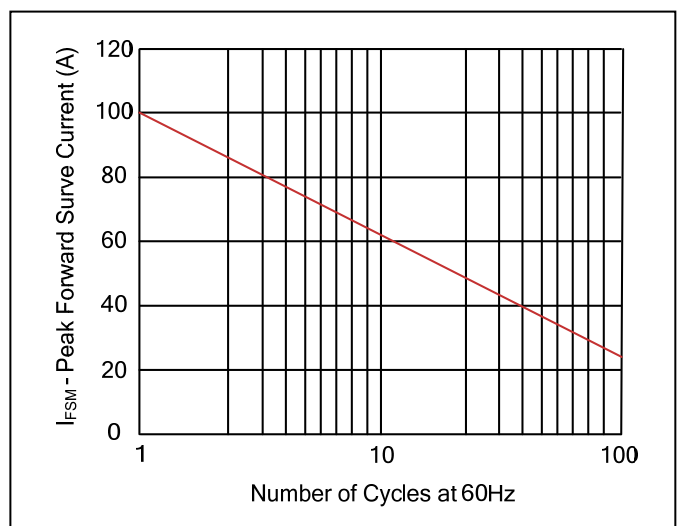

Figure 6. Maximum Non-Repetitive Forward Surge Current Uni-Directional Only



Recommended Soldering Conditions

Wave Soldering



| Item | Conditions |
|------------------|------------|
| Peak Temperature | 265°C |
| Dipping Time | 10 seconds |
| Soldering | 1 time |

Marking Code



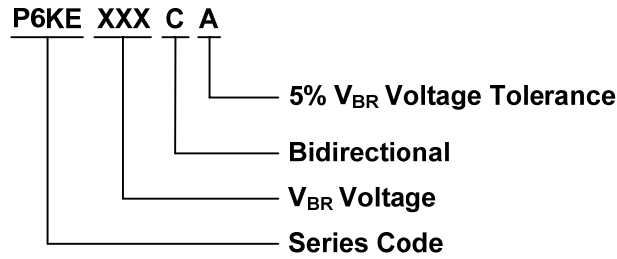

Packaging

| Tape | Symbol | Dimension (mm) |
|-------------|-------------------|----------------|
| | A | 5.0±0.5 |
| | B | 53.0±1.0 |
| | Z | 1.2Max. |
| | T | 6.0±0.4 |
| | E | 0.8Max. |
| | L1-L2 | 1.0Max. |
| | | |
| <p>Box</p> | L | 250.0±5.0 |
| | W | 75.0±5.0 |
| | H | 114.0±5.0 |
| | Quantity: 2000PCS | |
| <p>Reel</p> | D | 330.0±3.0 |
| | D0 | 16.4±2.0 |
| | D1 | 86.0±2.0 |
| | W1 | 76.0±3.0 |
| | Quantity: 4000PCS | |