



NDK Control Transformer

1. General

- 1.1 Frequency: AC 50Hz/60Hz;
- 1.2 Application: for control power supply of apparatus, partial illumination and indicator light of machine tool and other mechanic equipments.
- 1.3 Standard: Q/ZT258.

2. Type designation

N D K - □

Company code

Single-phase

Control

Rated output capacity (VA): 25VA~5000VA

3. Operating conditions

- 3.1 Temperature: $-5^{\circ}\text{C}\sim+40^{\circ}\text{C}$, the average value within 1 month should not exceed $+30^{\circ}\text{C}$ and not exceed $+20^{\circ}\text{C}$ within 1 year;
- 3.2 Altitude: $\leq 2000\text{m}$;
- 3.3 Relative humidity: $\leq 95\%$

4. Features

The transformer is characterized by excellent performances, reliable operation, compact design, safe wiring, and wide application, etc.

5. Technical data

Model	Capacity (VA)	Rated input voltage(V)	Rated output voltage(V)	Frequency (Hz)
NDK-25	25	230, 400	6, 12, 24, 36, 110, 127, 230, 400	50/60
NDK-50	50			
NDK-100	100			
NDK-150	150			
NDK-200	200			
NDK-250	250			
NDK-300	300			
NDK-400	400			
NDK-500	500			
NDK-700	700			
NDK-1000	1000			
NDK-1500	1500			
NDK-2000	2000			
NDK-3000	3000			
NDK-4000	4000			
NDK-5000	5000			

Note: Customized products are available.

6. Overall and mounting dimensions

NDK(BK)-25VA~1000VA

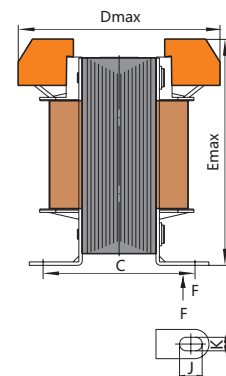
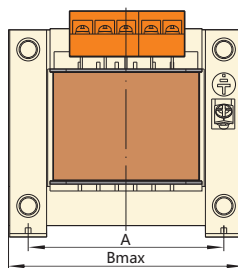
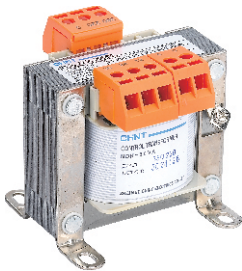

NDK(BK)-1500VA~5000VA

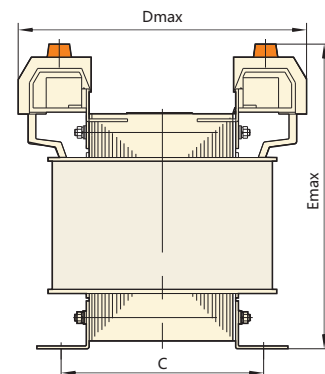
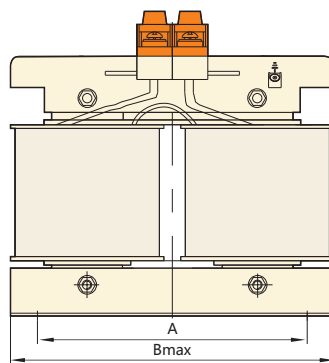

Model	Mounting dimensions (A×C) (mm)	Mounting holes (K×J) (mm)	Overall dimensions (B×D×E) (mm)
NDK-25	62.5×50	5×8	80×83×82
NDK-50	70×58	6×10	85×89×84
NDK-100	85×64	6×10	103×93×99
NDK-150	85×72	6×10	103×100×99
NDK-200	85×83	6×10	103×112×99
NDK-250	100×80	8×11	130×120×150
NDK-300	100×84	8×11	130×125×150
NDK-400	110×114	8×11	148×155×153
NDK-500	110×114	8×11	148×155×153
NDK-700	125×103	8×11	173×158×174
NDK-1000	125×123	8×11	173×186×174
NDK-1500	160×120	10×20	265×195×270
NDK-2000	160×130	10×20	265×205×280
NDK-3000	160×140	10×20	265×220×305
NDK-4000	190×160	10×20	315×240×305
NDK-5000	190×180	10×20	315×260×305

7. Wiring

7.1 NDK-100, capacity: 100VA, input 400V 230V, output 36V 24V 12V 6V

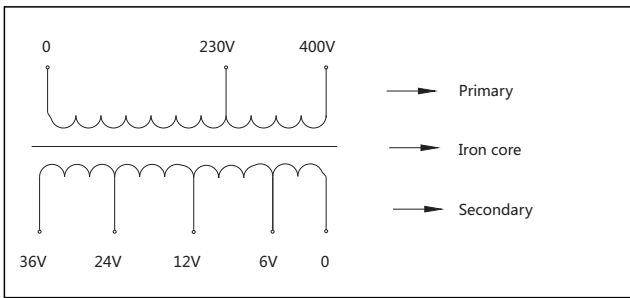

7.2 NDK-100, capacity: 100VA, input 400V, output 36V; capacity 60VA 12V; capacity 40VA

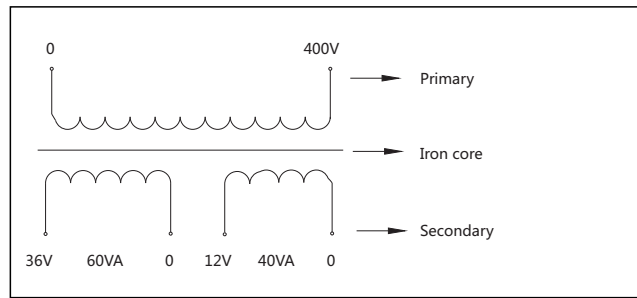

7.3 NDK-100, capacity: 100VA, input 400V, output 36V 12V

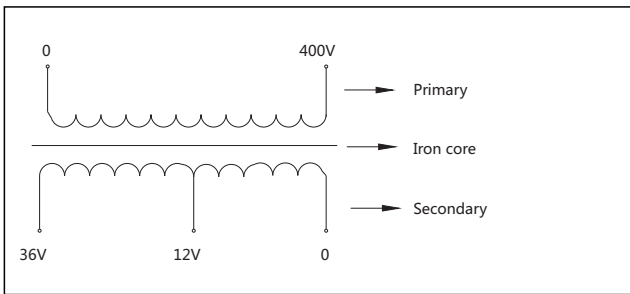

7.4 NDK-100, capacity: 100VA, input 400V, output 36V

