





Messrs.					
Product Specification	Model:	MTF-TQ28NP911-LB	Rev. No.	Issued Date.	Page.
			A	Feb.27,09	1 / 26

LIQUID CRYSTAL DISPLAY MODULE
MODEL: MTF-TQ28NP911-LB
Customer's No.:

Acceptance

Microtips Technology Inc.
12F. No.31 Lane 169, Kang Ning St.,
His-Chih, Taipei Hsien, Taiwan
FAX: 886-2-26958625

Approved and Checked by

Approved by	Checked by		Made by
			



Microtips Technology Inc.

Messrs.					
Product Specification	Model:	MTF-TQ28NP911-LB	Rev. No.	Issued Date.	Page.
			A	Feb.27,09	2 / 26

Revise Records

Rev.	Date	Contents	Written	Approved
A	2009/02/27	Specification released	Jill Hsu	Steele Lee

Special Notes

Note1.	
Note2.	
Note3.	
Note4.	
Note5.	



Messrs.					
Product Specification	Model:	MTF-TQ28NP911-LB	Rev. No.	Issued Date.	Page.
			A	Feb.27,09	3 / 26

Contents

1. GENERAL DESCRIPTION	4
2. FEATURES	5
3. MECHANICAL SPECIFICATION	4
4. ELECTRICAL CHARACTERISTICS	5
4.1 Backlight Characteristic	6
4.2 Touch Panel Pin Assignment	6
4.3 Pin Description	6
4.4 System Interface	6
4.5 GRAM Address Map & Read / Write	6
5. ELECTRO-OPTICAL CHARACTERISTICS	7
5.1 Reliability of Touch Panel	7
6. RELIABILITY	16
6.1 MTTF	17
6.2 Tests	17
7. INSPECTION CRITERIA	17
7.1 Inspection Conditions	16
7.2 Light Method	18
7.3 Classification of Defects	18
7.4 Sampling & Acceptable Quality Level	18
7.5 Definition Of Inspection Area	18
7.6 Items and Criteria	18
8. PRECAUTIONS	22
8.1 Operation	22
8.2 Safety	22
8.3 Handling	22
8.4 Static electricity	24
8.5 Storage	24
8.6 Cleaning	24
8.7 Waste	24
9. WARRANTY	25
10. DIMENSIONAL OUTLINES	25



Messrs.					
Product Specification	Model:	MTF-TQ28NP911-LB	Rev. No.	Issued Date.	Page.
			A	Feb.27,09	4 / 26

1. GENERAL DESCRIPTION

The MTF-TQ28NP911-LB model is a Color TFT LCD supplied by Microtips. This main Module has a 2.8 inch Diagonally measured active display area with 240 x RGB x 320 Resolution. Each pixel is divided into Red, Green and Blue sub-pixels and dots which are arranged in vertical stripes. LCD color is determined with Dithering 65K/262K Color signal for each pixel. The MTF-TQ28NP911-LB has been designed to apply the interface method that enables low power, high speed, and high contrast. The MTF-TQ28NP911-LB is intended to support Applications where thin thickness, wide viewing angle, low power are critical factors and graphic displays are important.

2. FEATURES

Display Mode	TFT module, Transmissive Type, Positive mode
Display Format	RGB vertical stripe
Color	56K/262K color
Input Data	MCU Mode : 8080 system ; 8/9/16/18 bits interface
Viewing Direction	12 O'clock
Backlight	White LED

3. MECHANICAL SPECIFICATION

Item	Specifications	Unit
Dimensional outline	50 (W) × 69.2 (H) × 3.8 (D) without fix posts & FPC tails.	mm
Resolution	240 x RGB x 320	Pixel
Active area	43.2 (W) × 57.6 (H)	mm
Pixel pitch	0.18 (W) × 0.18 (H)	mm
Dots pitch	0.06 (W) × 0.18 (H)	mm

* Not: Include FPC

* 1 Pixel =3 dots = Red dot + Green dot + Blue dot



Microtips Technology Inc.

Messrs.					
Product Specification	Model:	MTF-TQ28NP911-LB	Rev. No.	Issued Date.	Page.
			A	Feb.27,09	5 / 26

4. ELECTRICAL CHARACTERISTICS

Typical operating conditions (GND=AV ss=0V)

Item	Symbol	Min	Typ	Max	Units
Power Supply	VDD	--	2.8	--	V
	IDD	--	10	12	mA
Consumption current of VLED	VLED	--	--	3.5	V
	ILED	--	80	--	mA
Operating Temperature	TOP	-20	--	70	°C
Storage Temperature	TSTG	-30	--	80	°C
Humidity	--	--	90	%RH	Note1

Note1: $T_A \leq 40^\circ\text{C}$ Without dewing

4.1 Backlight Characteristic

Item	Symbol	Condition	Min	Typ	Max	Units
LED module voltage	VLED	ILED=20mA	--	--	3.5	V
LED module current	ILED	VLED=3.5V	--	80	--	mA
Surface brightness uniform (without LCD)	Ld	ILED=80mA VLED=3.5V	75	80	--	%

* 1 Backlight LED Circuit:

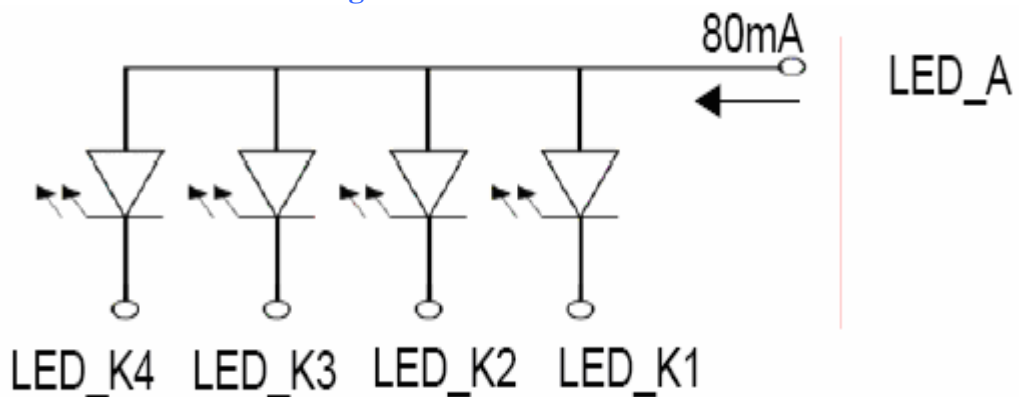

Messrs.					
Product Specification	Model:	MTF-TQ28NP911-LB	Rev. No.	Issued Date.	Page.
			A	Feb.27,09	6 / 26

*** 2 Uniform measure condition :**

- (a) Measure 9 point. Measure location is show below :
- (b) Uniform = (Min. brightness / Max. brightness) * 100%
- (c) Best Contrast, Main and sub panel All dots tum ON (White screen)

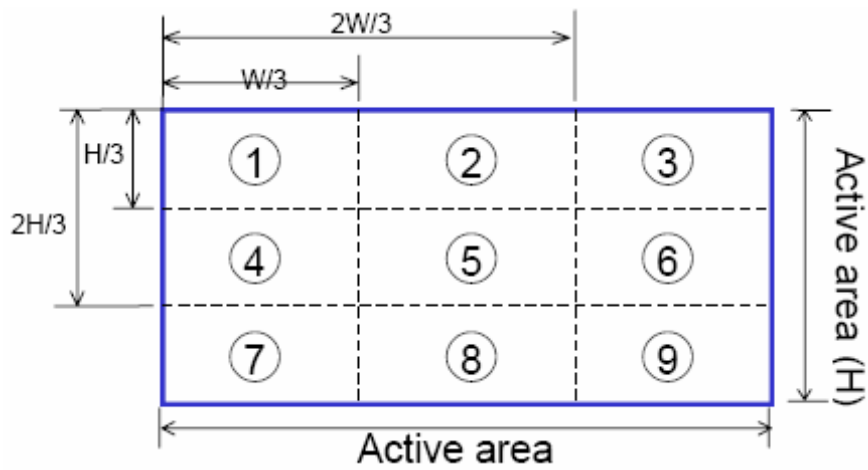

4.2 Touch Panel Pin Assignment

Pin No.	Designation
1	YU
2	XL
3	YD
4	XR



Messrs.					
Product Specification	Model:	MTF-TQ28NP911-LB	Rev. No.	Issued Date.	Page.
			A	Feb.27,09	7 / 26

4.3 Pin Description

No	Pin Name	Functions		
1	VDD	Power input (+2.8V)		
2	VDD	Power input (+2.8V)		
3	GND	Power Ground		
4	GND	Power Ground		
5	CS	Chip Select Input PIN		
6	RS	Register Select Input PIN		
7	WR	Chip Select Input PIN		
8	RD	Read Data Select Input PIN		
9~26	DB0~DB17	Data Bus Pin		
27	RESET	Reset Select Input PIN		
28	GND	Power Ground		
29~30	IM0~IM3	Mode Select		
		IM0	IM3	Interface
		0	1	8-bits
		1	1	9-bits
		0	0	16-bits
		1	0	18-bits
31	K4	B/L Power input PIN negative		
32	K3	B/L Power input PIN negative		
33	K2	B/L Power input PIN negative		
34	K1	B/L Power input PIN negative		
35	AN	B/L Power input PIN anode		
36	NC/ YU	Not Connect		
37	NC/ XL	Not Connect		
38	NC/ YD	Not Connect		
39	NC/ XR	Not Connect		
<p>Note :</p> <ul style="list-style-type: none"> 80-system 8-bits used DB17 : DB10 80-system 9-bits used DB17 : DB9 80-system 16-bits used DB17 : DB10 and DB7 : DB0 80-system 18-bits used DB17 : DB0 				



Messrs.					
Product Specification	Model:	MTF-TQ28NP911-LB	Rev. No.	Issued Date.	Page.
			A	Feb.27,09	8 / 26

4.4 System Interface

4.4.1 8080-System Interface Timing

Item		Symbol	Unit	Min	Typ	Max	Test Condition
Bus cycle time	Write	t _{CYCW}	ns	100	--	--	--
	Read	t _{CYCR}	ns	300	--	--	--
Write low-level pulse width		PW _{LOW}	ns	50	--	500	--
Write high-level pulse width		PW _{HW}	ns	50	--	--	--
Read low-level pulse width		PW _{LR}	ns	150	--	--	--
Read high-level pulse width		PW _{HR}	ns	150	--	--	--
Write / Read rise / fall time		t _{WRi} /t _{WRf}	ns	--	--	25	--
Setup time	Write (RS to NCS ,E/NWR)	t _{AS}	ns	10	--	--	--
	Read (RS to NCS ,RW/NRD)			5	--	--	
Address hold time		t _{AH}	ns	5	--	--	--
Write data set up time		t _{DSW}	ns	10	--	--	--
Write data hold time		t _H	ns	15	--	--	--
Read data delay time		t _{DDR}	ns	--	--	100	--
Read data hold time		t _{DHR}	ns	5	--	--	--



Messrs.					
Product Specification	Model:	MTF-TQ28NP911-LB	Rev. No.	Issued Date.	Page.
			A	Feb.27,09	9 / 26

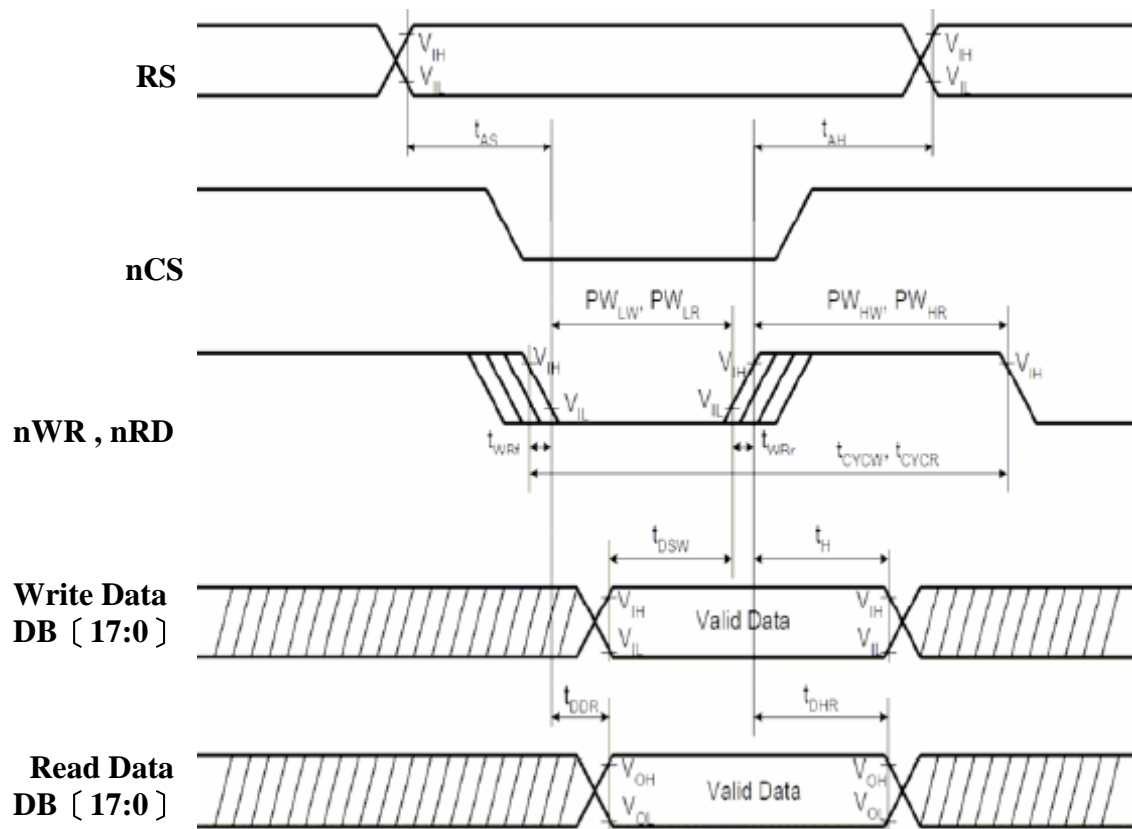

4.4.2 Reset Timing

Item	Symbol	Units	Min	Typ	Max
Reset Low-Level Width	t_{RES}	ms	1	--	--
Reset Rise Time	t_{RES}	us	--	--	10



Product Specification	Model:	MTF-TQ28NP911-LB	Rev. No.	Issued Date.	Page.
			A	Feb.27,09	10 / 26

4.4.3 Power ON/OFF

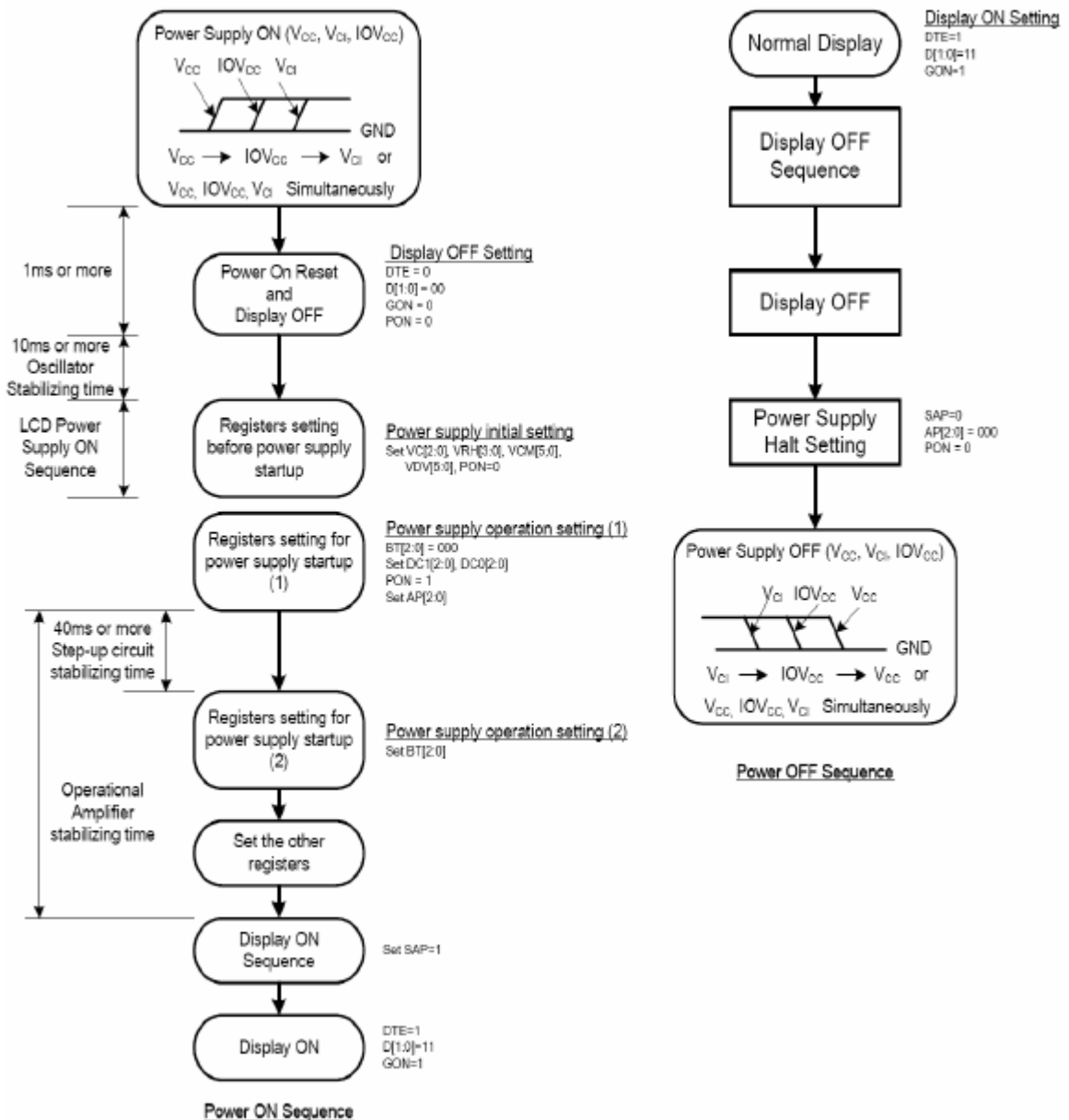

Messrs.					
Product Specification	Model:	MTF-TQ28NP911-LB	Rev. No.	Issued Date.	Page.
			A	Feb.27,09	11 / 26

4.4.4 Display ON/OFF

Display off Flow

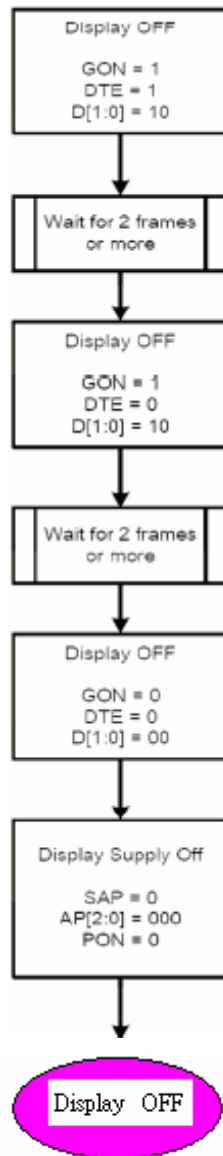

Display on Flow

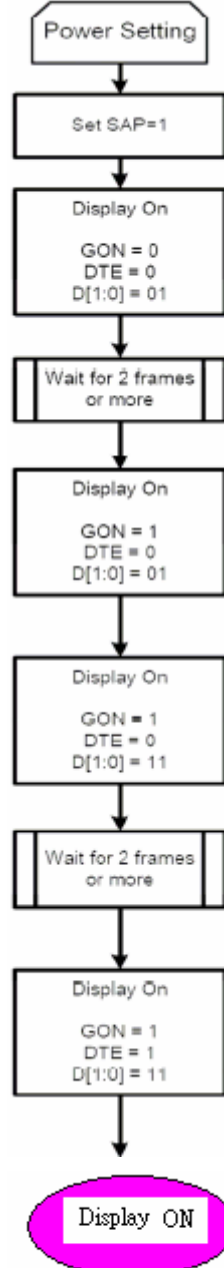

Messrs.					
Product Specification	Model:	MTF-TQ28NP911-LB	Rev. No.	Issued Date.	Page.
			A	Feb.27,09	12 / 26

4.5 GRAM Address Map & Read / Write

[! 80 18-/16-bit System Bus Interface Timing](#)

(a) Write to GRAM

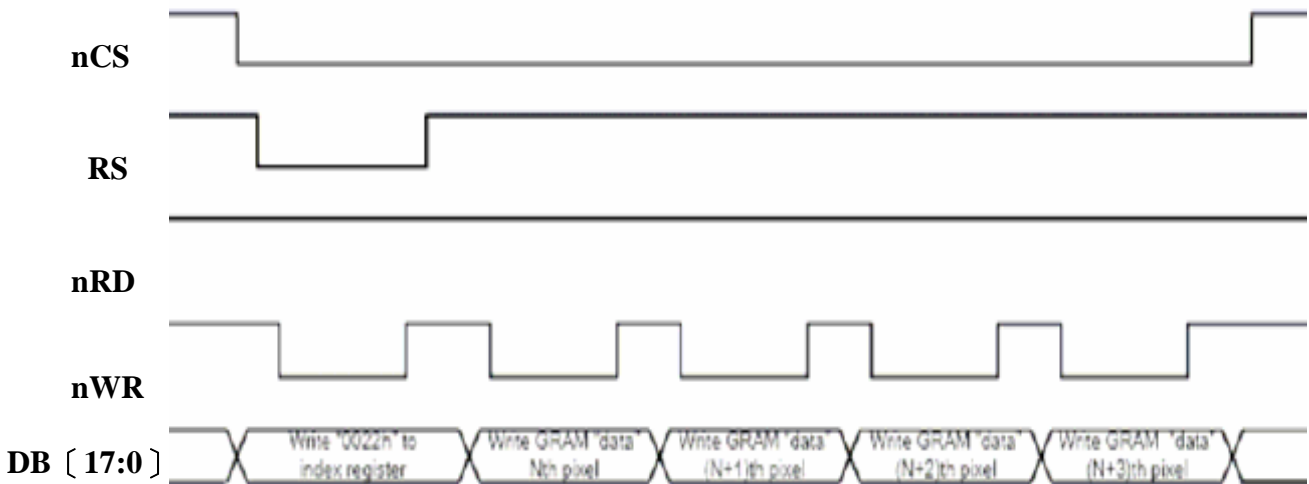

(b) Read form GRA

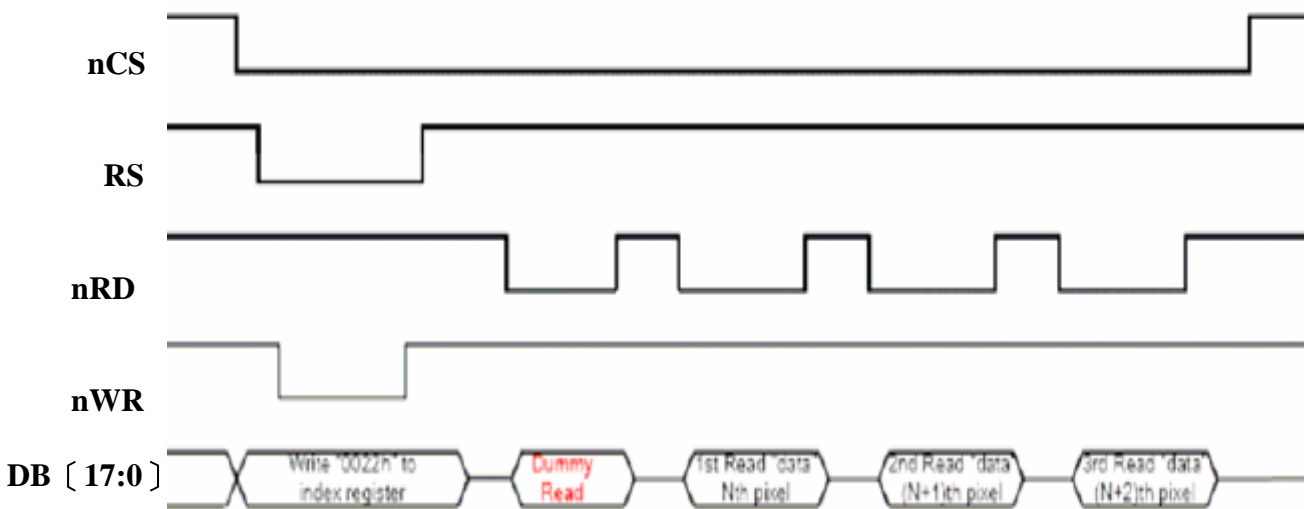

Messrs.					
Product Specification	Model:	MTF-TQ28NP911-LB	Rev. No.	Issued Date.	Page.
			A	Feb.27,09	13 / 26

! 80 9-/ 8-bit System Bus Interface Timing

(a) Write to GRAM

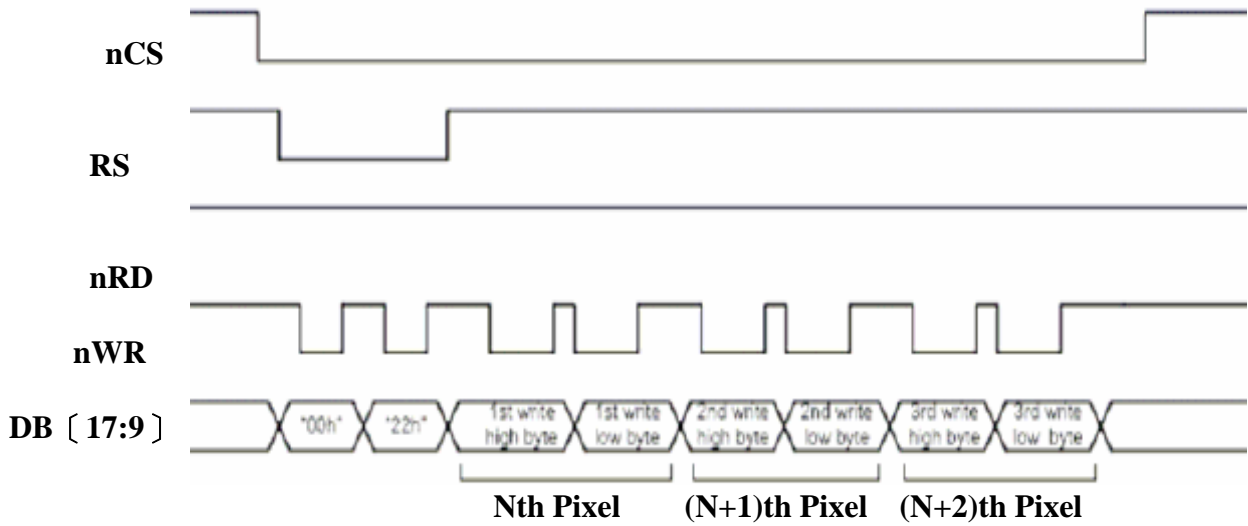

(b) Read form GRA

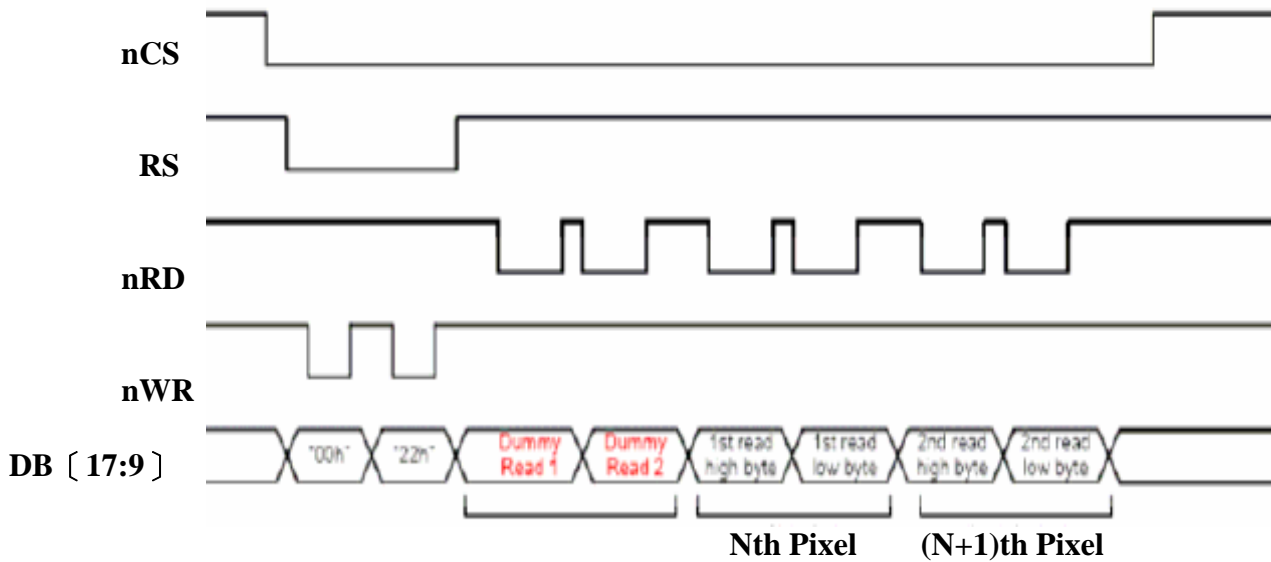

Messrs.					
Product Specification	Model:	MTF-TQ28NP911-LB	Rev. No.	Issued Date.	Page.
			A	Feb.27,09	14 / 26

5. ELECTRO-OPTICAL CHARACTERISTICS

Parameter		Symbol.	Min.	Typ.	Max.	Units.	Note.
Luminance of white		Lwh	170	--	--	cd/m ²	--
Contrast Ratio		CR	--	300	--	--	* 5
Response Time (Tr + Tf)		--	--	30	--	ms	* 4
Viewing Angle (CR ≥ 10)	X axis right ($\phi = 0^\circ$)	θ_x	--	60	--	Degree	* 6
	X axis left ($\phi = 180^\circ$)	θ_x	--	60	--		
	Y axis up ($\phi = 90^\circ$)	θ_y	--	60	--		
	Y axis down ($\phi = 270^\circ$)	θ_y	--	50	--		
CIE color Coordinates	White	Wx	0.290	0.310	0.330	--	BM7; 2° angle
		Wy	0.323	0.343	0.363		
	Red	Rx	0.584	0.604	0.624		
		Ry	0.305	0.325	0.345		
	Green	Gx	0.279	0.299	0.319		
		Gy	0.547	0.567	0.587		
Blue	Bx	0.115	0.135	0.155			
	By	0.127	0.147	0.167			

● **For LCM**

Note1: Ambient temperature=25°C±2°C.

Note2: To be measured in the dark room.

Note3: To be measured at the center area of panel with a viewing cone of 2° by
Topcon luminance meter BM-7, after 10 minutes operation (module).



Microtips Technology Inc.

Messrs.					
Product Specification	Model:	MTF-TQ28NP911-LB	Rev. No.	Issued Date.	Page.
			A	Feb.27,09	15 / 26

Note4: Definition of response time:

The output signals of photo detector are measured when the input signals are changed from "black" to "white" (falling time) and from "white" to "black" (rising time), respectively. The response time is defined as the time interval between the 10% and 90% of amplitudes.

Refer to figure as below:

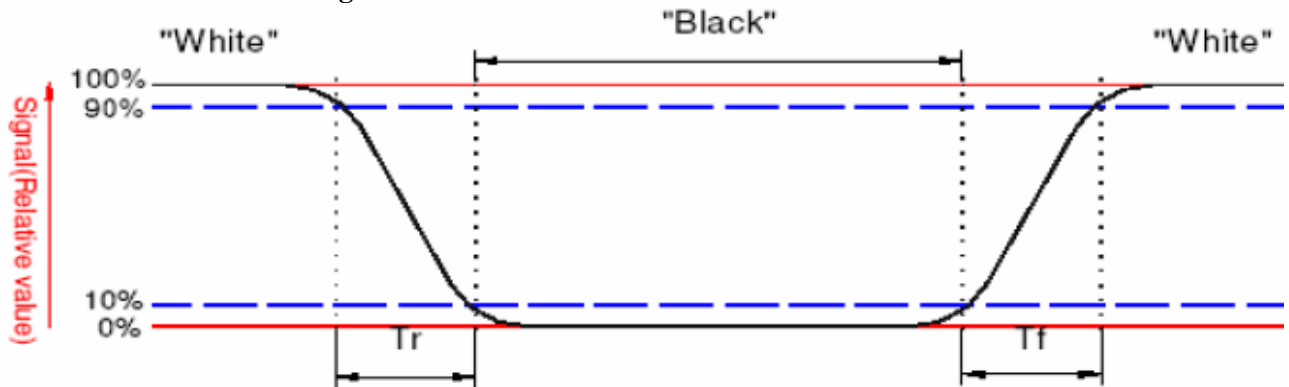

Note5: Definition of contrast ratio: **Contrast ratio is calculated with the following formula.**

$$\text{Contrast ratio (CR)} = \frac{\text{Photo detector output when LCD is at "White" state}}{\text{Photo detector output when LCD is at "Black" state}}$$

Note6: Definition of viewing angle (LCD-5200): **Refer to the figure as below**

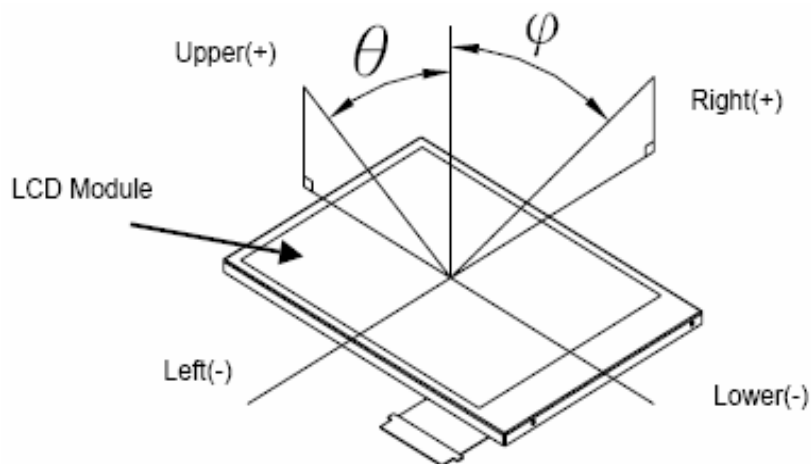

5.1 Reliability of Touch Panel



Microtips Technology Inc.

Messrs.					
Product Specification	Model:	MTF-TQ28NP911-LB	Rev. No.	Issued Date.	Page.
			A	Feb.27,09	16 / 26

No	Items	Min.	Typ.	Max.	Unit	Remark
1	Activation Force	130	--	--	g	1. within active area. 2. R0.8mm polyacetal pen or finger.
2	Surface Hardness	3	--	--	H	Judgment ref. JIS-K5600
3	Durability (Writing Life)	100,000	--	--	characters	1. within active area. 2. R0.8mm polyacetal pen. 3. Load: 150g 4. Speed: 60mm/sec
4	Durability (Pitting Life)	1,000,000	--	--	touches	1. within active area. 2. R0.8mm polyacetal pen. 3. Load: 250g 4. Frequency: 260 times/min

6. RELIABILITY

6.1 MTTF

The LCD module shall be designed to meet a minimum MTTF value of 50,000 hours with normal condition.

(25°C in the room without sunlight; not include life time of backlight)

6.2 Tests

NO	Item	Condition	Criterion
1	High Temperature Operating	70°C 240hrs	* No defect of Operational function in Room temperature are Allowable.
2	Low Temperature Operating	-20°C 240hrs	
3	High Temperature Non-Operating	80°C 240hrs	
4	Low Temperature Non-Operating	-30°C 240hrs	
5	High Temperature / Humidity Non-Operating	50°C , 90%HR 240hrs	* Leakage current should Be below double of initial value.
6	Temperature Shock Non-Operating	-30°C ↔ 80°C (30min) (5min) (30min) 10 CYCLES	
	Electro-static Discharge	HBM : ±2Kv	

Note1: Test after 24 hours in room temperature.

Note2: The sampling above is Individually for each reliability testing condition.

Note3: The color fading of polarizing filter should not care.

Note4: All of the reliability testing chamber above, is using D.I. water. (Min value: 1.0 MΩ-cm)

Note5: In case of malfunction defect caused by ESD damage, if it would be recovered to Normal state after resetting, it would be judged as a good part.



Microtips Technology Inc.

Messrs.					
Product Specification	Model:	MTF-TQ28NP911-LB	Rev. No.	Issued Date.	Page.
			A	Feb.27,09	17 / 26

7. INSPECTION CRITERIA

7.1 Inspection Conditions

Environmental conditions

The environmental conditions for inspection shall be as follows

Room temperature: $23\pm 5^{\circ}\text{C}$

Humidity: $50\pm 20\% \text{RH}$

The external visual inspection

With a single 1000 ± 200 lux fluorescent lamp as the light source, the inspection was in the distance of 30cm or more from the LCD to the inspector's eyes.

7.2 Light Method

Environment lamp under 1000 ± 200 lux, Viewing direction for inspection over 30cm The distance from eye to defect around 300mm, the distance from ND Filter to defect around 25~30mm

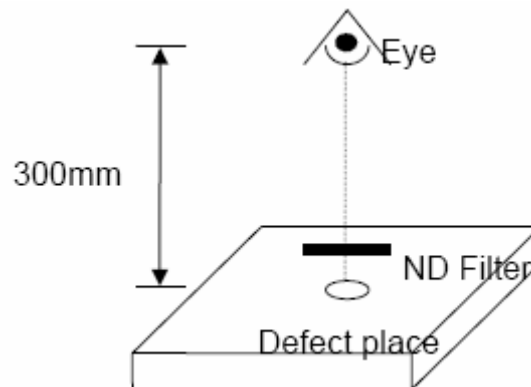

7.3 Classification of Defects

Minor defect

A major defect refers to a defect that may substantially degrade usability for product applications.

Minor defect

A minor defect refers to a defect which is not considered to be able substantially degrade the Product application or a defect that deviates from existing standards almost unrelated to the effective use of the product or its operation.

Notes: If the LCD/LCM 's cosmetic and display performance do not specify in "inspection criterion", it should be based on these delivered samples.



Messrs.					
Product Specification	Model:	MTF-TQ28NP911-LB	Rev. No.	Issued Date.	Page.
			A	Feb.27,09	18 / 26

7.4 Sampling & Acceptable Quality Level

Level II, MIL-STD-105E

--	Major	Minor
Cosmetic	1.0 %	1.5 %
Electrical-display	0.4%	0.65 %

7.5 Definition Of Inspection Area

V.A: Viewing Area

A.A: Active Area

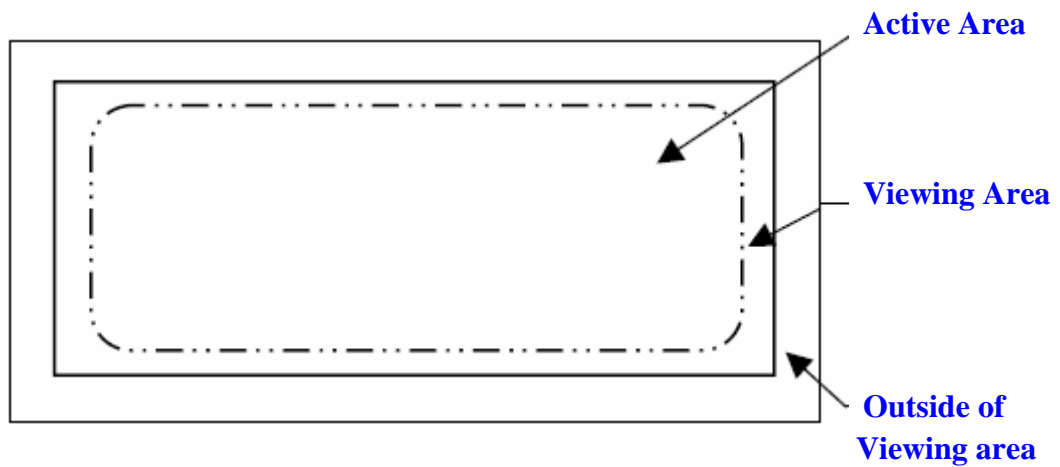

Messrs.					
Product Specification	Model:	MTF-TQ28NP911-LB	Rev. No.	Issued Date.	Page.
			A	Feb.27,09	19 / 26

7.6 Items and Criteria
Visual inspection criterion in cosmetic

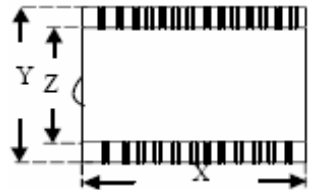
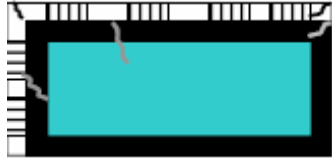
Glass defect			
No	Defect	Criteria	Remark
1	Dimension (Minor)	By engineering diagram	
2	Cracks (Major)	Extensive crack 【Reject】	

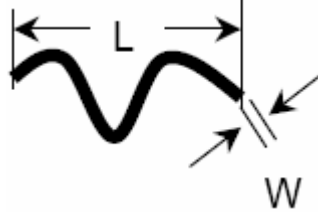
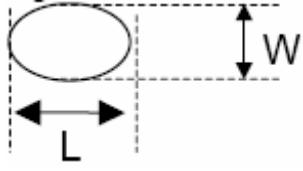
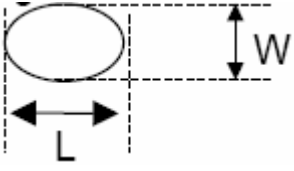
LCD appearance defect with in V.A				
No	Defect	Criteria		Remark
1	Fiber, scratches (Major)	Spec.	Permissible Qty	1. L: Length, W: Width 2. Disregard if out off A.A. 
		$W \leq 0.03\text{mm}$	Disregard	
		$0.03\text{mm} < W \leq 0.05\text{mm}$, $L \leq 3.0\text{mm}$	2	
		$0.05\text{mm} < W \leq 0.10\text{mm}$, $L \leq 3.0\text{mm}$	1	
		$W > 0.10\text{mm}$ or $L > 3.0\text{mm}$	0	
2	Dirty Spots, Round type (Major)	Spec.	Permissible Qty	1. $\phi = (L+W)/2$, L: Length, W: Width 2. Disregard if out of A.A. 
		$\phi \leq 0.10\text{mm}$	Disregard	
		$0.10\text{mm} < \phi \leq 0.20\text{mm}$	3	
		$0.20\text{mm} < \phi$	0	
3	Polarizer dent (Major)	Spec.	Permissible Qty	1. $\phi = (L+W)/2$, L: Length, W: Width 2. Disregard if out of A.A. 
		$\phi \leq 0.20\text{mm}$	Disregard	
		$0.20\text{mm} < \phi \leq 0.30\text{mm}$	2	
		$0.30\text{mm} < \phi \leq 0.50\text{mm}$	1	
		$0.50\text{mm} < \phi$	0	

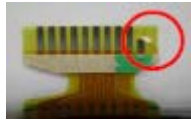

Messrs.					
Product Specification	Model:	MTF-TQ28NP911-LB	Rev. No.	Issued Date.	Page.
			A	Feb.27,09	20 / 26

FPC			
No	Item	Criteria	Remark
1	Copper Peeling (Minor)	Copper Peeling 【Reject】	

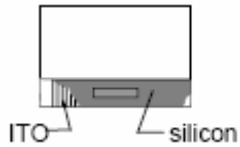
Silicon			
No	Item	Criteria	Remark
1	Amount of silicon (Minor)	ITO exposed 【Reject】	

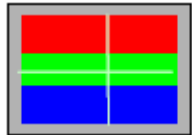
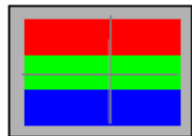
LCD appearance defect				
No	Defect	Criteria		Remark
1	No display (Major)	Not allowable		
2	Missing line (Major)	Not allowable		
3	Darker or lighter line (Major)	By limited sample		
4	Dot defect (Major)	Spec.	Permissible Qty	1. dot =1R or 1G or 1B 2. Dot defect area $\geq 1/2$ dot 3. Disregard if out of AA area
		Bright dot	1	
		Dark dot	2	
5	Mura (Minor)	By limited sample		--

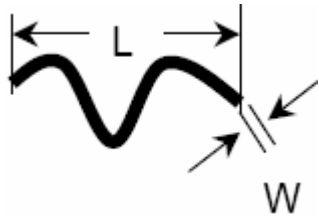
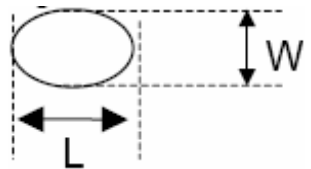

Messrs.					
Product Specification	Model:	MTF-TQ28NP911-LB	Rev. No.	Issued Date.	Page.
			A	Feb.27,09	21 / 26

LCD appearance defect				
No	Defect	Criteria		Remark
6	Fiber, scratches (Major)	Spec.	Permissible Qty	1. L: Length, W: Width 2. Disregard if out off A.A. 
		$W \leq 0.03\text{mm}$	Disregard	
		$0.03\text{mm} < W \leq 0.05\text{mm}$, $L \leq 3.0\text{mm}$	2	
		$0.05\text{mm} < W \leq 0.10\text{mm}$, $L \leq 3.0\text{mm}$	1	
		$W > 0.10\text{mm}$ or $L > 3.0\text{mm}$	0	
7	Dirty spots (Major)	Spec.	Permissible Qty	1. $\phi = (L+W)/2$, L: Length, W: Width 2. Disregard if out of A.A. 
		$\phi \leq 0.10\text{mm}$	Disregard	
		$0.10\text{mm} < \phi \leq 0.20\text{mm}$	3	
		$0.20\text{mm} < \phi$	0	

Others

1. Issues that are not defined in this document shall be discussed and agreed with both parties.
(Customer and supplier)
2. Unless otherwise agreed upon in writing, the criteria shall be applied to both parties.
(Customer and supplier)



Microtips Technology Inc.

Messrs.					
Product Specification	Model:	MTF-TQ28NP911-LB	Rev. No.	Issued Date.	Page.
			A	Feb.27,09	22 / 26

8. PRECAUTIONS





8.1 Operation

Burn-in sometimes happens when the same character was displayed at along time. Therefore, to prevent Burn-in, it is recommended to set up a Screen-saver function.

8.2 Safety





The liquid crystal in the LCD is poisonous, DO NOT put it in your mouth. If the liquid crystal touches your skin or clothes, wash it off immediately using soap and water.

8.3 Handling

	<p>a. The LCD module shall be installed flat, without twisting or bending.</p> <p>b. COF or FPC has narrow pattern width, so easily become open circuit by external force. DO NOT apply pressure to COF or FPC especially in bending area.</p>
	<p>c. To avoid damage in appearance or malfunction, DO NOT subject the module to mechanical shock or to excessive force on its surface.</p>
	<p>d. The polarizer attached to the display is very easy to be damaged, handle it with care to avoid scratching.</p>
	<p>e. To avoid contamination on the display surface, DO NOT touch the display surface with bare hands.</p> <p>f. Provide a space so that the LCD module does not come into contact with other components.</p>

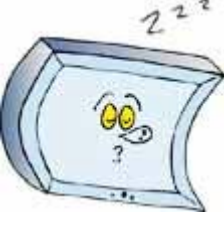
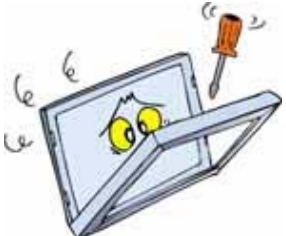

Messrs.					
Product Specification	Model:	MTF-TQ28NP911-LB	Rev. No.	Issued Date.	Page.
			A	Feb.27,09	23 / 26

	<p>g. To protect the LCD panel from external pressure, put covering glass (acrylic board or similar board) to keep appropriate space between them.</p>
	<p>h. Be careful for condensation at sudden temperature change. Condensation makes damage to polarizer or electrical contacted parts. And after fading condensation, smear or spot will occur.</p>
	<p>i. Property of semiconductor devices may be affected when they are exposed to light possibly resulting in malfunctioning of the ICs. To prevent such malfunctioning of the ICs, your design and mounting layout done are so that the IC is not exposed to light in actual use.</p>
	<p>j. Strong light exposure causes degradation of color filter. It may not recover</p>
	<p>k. DO NOT contact with water to avoid Metal corrosion.</p> <p>l. When it is not in use, the screen must be turned off or the pattern must be frequently changed by a screen saver. If it displays the same pattern for a long period of time, brightness down/image sticking may develop due to the LCD structure.</p>
	<p>m. Never disassemble LCD product under any circumstances. If unqualified operators or users assemble the product after disassembling it, it may not function or its operation may be seriously affected.</p>



Messrs.					
Product Specification	Model:	MTF-TQ28NP911-LB	Rev. No.	Issued Date.	Page.
			A	Feb.27,09	24 / 26

8.4 Static electricity

Since a module is composed of electronic circuits, it is not strong to electrostatic discharge.

	<ol style="list-style-type: none"> The LCD module shall be installed flat, without twisting or bending. Ground soldering iron tips, tools and testers when they operate. Ground your body when handling the products. DO NOT apply voltage to the input terminal without applying power supply. DO NOT apply voltage that exceeds the absolute maximum rating. Store the products in an anti-electrostatic container. Peel off protect tape, attached to polarizer, slowly to minimize ESD damage.
---	--

8.5 Storage

	<p>Store the products in a dark place at +5 ~ +25 degree C, low humidity (50%RH or less). DO NOT store the products in an atmosphere containing organic solvents or corrosive gases.</p>
---	--

8.6 Cleaning

	<ol style="list-style-type: none"> DO NOT wipe the polarizer with dry cloth, as it might cause scratch. Wipe the polarizer with a soft cloth soaked with petroleum IPA, other chemical might damage.
---	--

8.7 Waste

	<p>When dispose of LCD module, manage it at the production waste according to the relevant laws and regulations.</p>
---	--



Messrs.					
Product Specification	Model:	MTF-TQ28NP911-LB	Rev. No.	Issued Date.	Page.
			A	Feb.27,09	25 / 26

9. WARRANTY

This product has been manufactured to your company's specifications as a part for use in your company's general electronic products. It is guaranteed to perform according to delivery specifications. For any other use apart from general electronic equipment, we cannot take responsibility if the product is used in medical devices, nuclear power control equipment, aerospace equipment, fire and security systems, or any other applications in which there is a direct risk to human life and where extremely high levels of reliability are required. If the product is to be used in any of the above applications, we will need to enter into a separate product liability agreement.

- 1 13 months guarantee starts from the date code.
- 2 We cannot accept responsibility for any defect, which may arise from additional manufacturing of the product (including disassembly and reassembly), after product delivery.
- 3 We cannot accept responsibility for any defect, which may arise after the application of strong external force to the product.
- 4 We cannot accept responsibility for any defect, which may arise due to the application of static electricity after the product has passed your company's acceptance inspection procedures.
- 5 We cannot accept responsibility for industrial property, which may arise through the use of your product, with exception to those issues relating directly to the structure or method of manufacturing of our product. Microtips-origin longer than one year from Microtips production.

10. DIMENSIONAL OUTLINES

See next page.....



Microtips Technology Inc.

REV.	DESCRIPTION	3	2	1

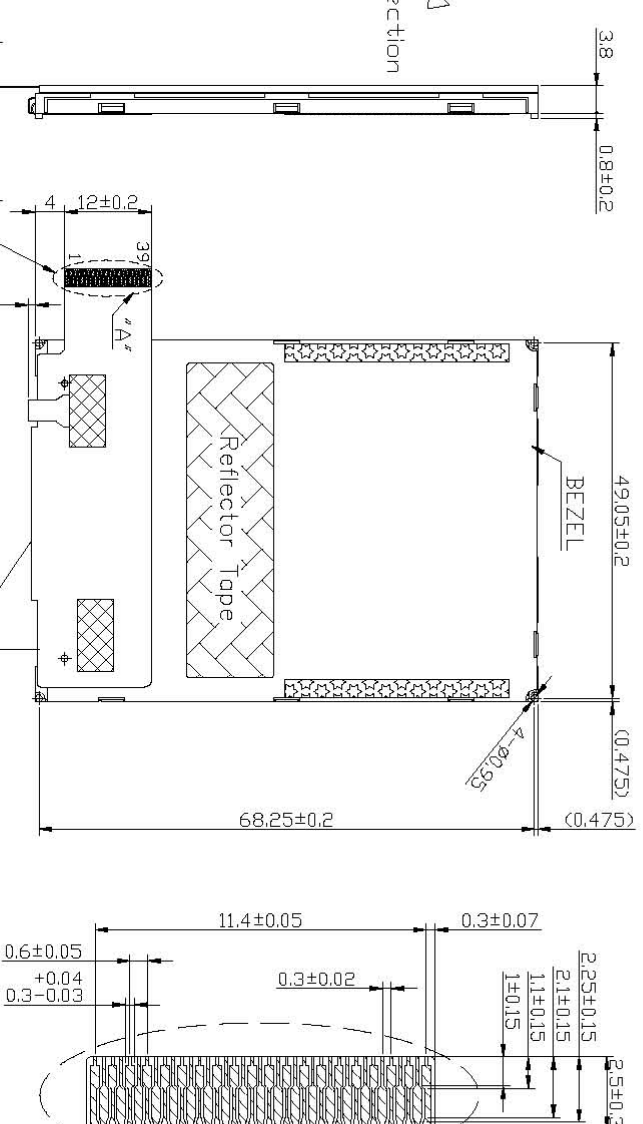
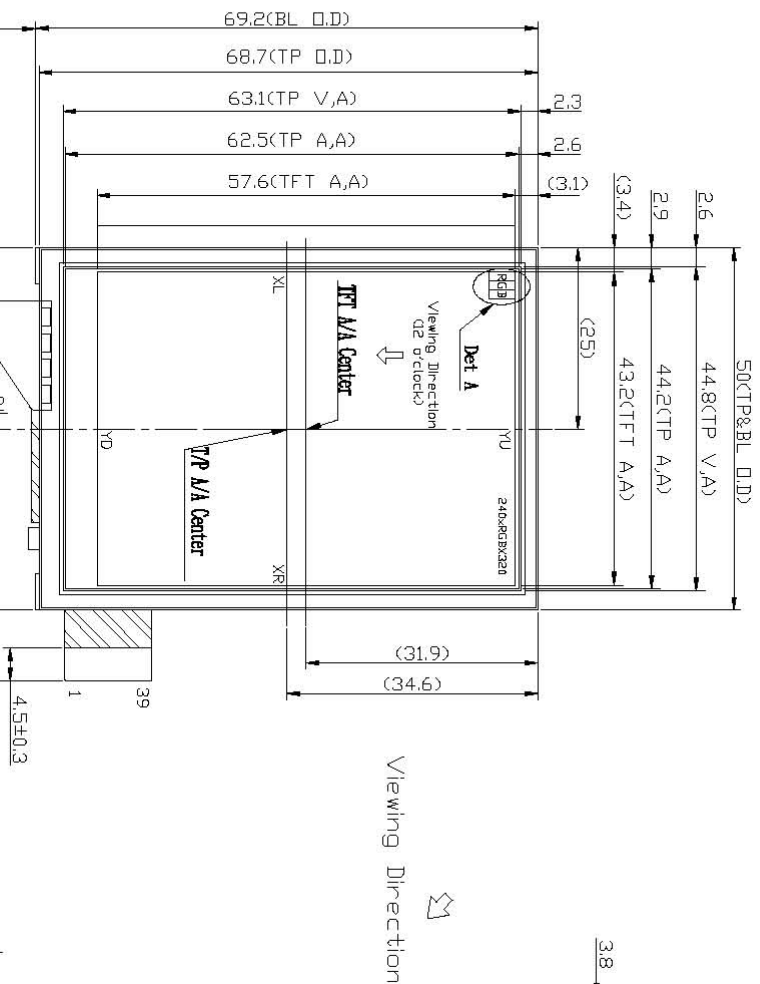

DETAIL 'A'
SCALE 4/1

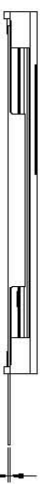
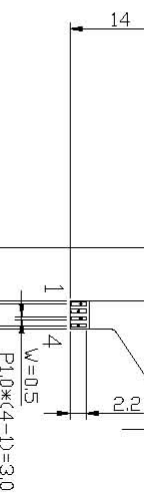

- Note:
1. Operating Temperature: -20° to 70°
 2. Storage Temperature: 30° to 80°
 3. Brightness: 170 cd/m²(Min)
 4. No specified TOL ±0.3
 5. Circuit Diagram of Backlight

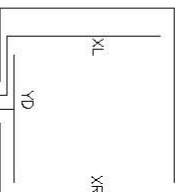
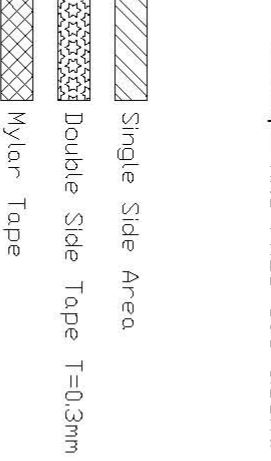
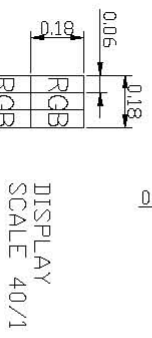
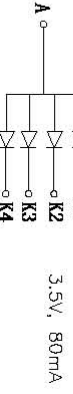

N/NAME	N/NAME	N/NAME	N/NAME				
1	VDD	11	DB2	21	DB12	31	K4
2	VDD	12	DB3	22	DB13	32	K3
3	GND	13	DB4	23	DB14	33	K2
4	GND	14	DB5	24	DB15	34	K1
5	CS	15	DB6	25	DB16	35	AN
6	RS	16	DB7	26	DB17	36	NC
7	WR	17	DB8	27	RESET	37	NC
8	RD	18	DB9	28	GND	38	NC
9	DB0	19	DB10	29	IM0	39	NC
10	DB1	20	DB11	30	IM3		

PIN FUNCTION:

	ND.	M-FTQ28NP911-LB	QTY	02/17/09	MATERIAL	
	PART NAME	PART NAME	DATE	SCALE: 1/1	FINISH	
	DRAWN	CHECK	APP'D	UNIT:MM	FOR MODULE:MTF-1028NP911-LB	
					UNLESS OTHERWISE SPECIFIED TOLERANCE IN FRACTIONS DECIMALS ANGLES	0.10 0.5°
					FILE: D:\Design\140\1\WVP\WVP-1028NP911-LB.DWG	
					SHEET 1 / 1	Rev: X

Mouser Electronics

Authorized Distributor

Click to View Pricing, Inventory, Delivery & Lifecycle Information:

[Microtips Technology:](#)

[MTF-TQ28NP742-LB](#) [MTF-TQ28NP911-LB](#) [MTF-TQ28NP721-V](#)