

MMBT5550LT1, MMBT5551LT1

MMBT5551LT1 is a Preferred Device

High Voltage Transistors

NPN Silicon

Features

- Pb-Free Packages are Available

MAXIMUM RATINGS

Rating	Symbol	5550	5551	Unit
Collector-Emitter Voltage	V_{CEO}	140	160	Vdc
Collector-Base Voltage	V_{CBO}	160	180	Vdc
Emitter-Base Voltage	V_{EBO}	6.0		Vdc
Collector Current - Continuous	I_C	600		mAdc

Maximum ratings are those values beyond which device damage can occur. Maximum ratings applied to the device are individual stress limit values (not normal operating conditions) and are not valid simultaneously. If these limits are exceeded, device functional operation is not implied, damage may occur and reliability may be affected.

THERMAL CHARACTERISTICS

Characteristic	Symbol	Max	Unit
Total Device Dissipation FR-5 Board (Note 1) $T_A = 25^\circ\text{C}$ Derate Above 25°C	P_D	225	mW
Thermal Resistance, Junction-to-Ambient	$R_{\theta JA}$	556	$^\circ\text{C}/\text{W}$
Total Device Dissipation Alumina Substrate (Note 2) $T_A = 25^\circ\text{C}$ Derate Above 25°C	P_D	300	mW
Thermal Resistance, Junction-to-Ambient	$R_{\theta JA}$	417	$^\circ\text{C}/\text{W}$
Junction and Storage Temperature	T_J, T_{stg}	-55 to +150	$^\circ\text{C}$

- FR-5 = $1.0 \times 0.75 \times 0.062$ in.
- Alumina = $0.4 \times 0.3 \times 0.024$ in. 99.5% alumina.



ON Semiconductor®

<http://onsemi.com>

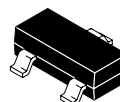
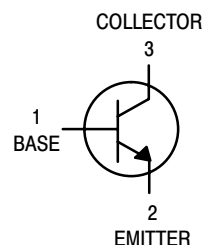

SOT-23 (TO-236)
CASE 318
STYLE 6

MARKING DIAGRAM

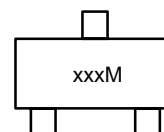

xxx = MMBT5550LT1 = M1F,
MMBT5551LT1, LT3, LT1G = G1
M = Month Code

ORDERING INFORMATION

Device	Package	Shipping [†]
MMBT5550LT1	SOT-23	3000 Tape & Reel
MMBT5550LT1G	SOT-23 (Pb-Free)	3000 Tape & Reel
MMBT5551LT1	SOT-23	3000 Tape & Reel
MMBT5551LT1G	SOT-23 (Pb-Free)	3000 Tape & Reel
MMBT5551LT3	SOT-23	10,000 Tape & Reel
MMBT5551LT3G	SOT-23 (Pb-Free)	10,000 Tape & Reel

[†]For information on tape and reel specifications, including part orientation and tape sizes, please refer to our Tape and Reel Packaging Specifications Brochure, BRD8011/D.

Preferred devices are recommended choices for future use and best overall value.

MMBT5550LT1, MMBT5551LT1

ELECTRICAL CHARACTERISTICS ($T_A = 25^\circ\text{C}$ unless otherwise noted)

Characteristic		Symbol	Min	Max	Unit
OFF CHARACTERISTICS					
Collector – Emitter Breakdown Voltage (Note 3) ($I_C = 1.0\text{ mA}$, $I_B = 0$)	MMBT5550 MMBT5551	$V_{(BR)CEO}$	140 160	– –	Vdc
Collector – Base Breakdown Voltage ($I_C = 100\text{ }\mu\text{A}$, $I_E = 0$)	MMBT5550 MMBT5551	$V_{(BR)CBO}$	160 180	– –	Vdc
Emitter – Base Breakdown Voltage ($I_E = 10\text{ }\mu\text{A}$, $I_C = 0$)		$V_{(BR)EBO}$	6.0	–	Vdc
Collector Cutoff Current ($V_{CB} = 100\text{ Vdc}$, $I_E = 0$) ($V_{CB} = 120\text{ Vdc}$, $I_E = 0$) ($V_{CB} = 100\text{ Vdc}$, $I_E = 0$, $T_A = 100^\circ\text{C}$) ($V_{CB} = 120\text{ Vdc}$, $I_E = 0$, $T_A = 100^\circ\text{C}$)	MMBT5550 MMBT5551 MMBT5550 MMBT5551	I_{CBO}	– – – –	100 50 100 50	nAdc μAdc
Emitter Cutoff Current ($V_{EB} = 4.0\text{ Vdc}$, $I_C = 0$)		I_{EBO}	–	50	nAdc
ON CHARACTERISTICS					
DC Current Gain ($I_C = 1.0\text{ mA}$, $V_{CE} = 5.0\text{ Vdc}$) ($I_C = 10\text{ mA}$, $V_{CE} = 5.0\text{ Vdc}$) ($I_C = 50\text{ mA}$, $V_{CE} = 5.0\text{ Vdc}$)	MMBT5550 MMBT5551 MMBT5550 MMBT5551 MMBT5550 MMBT5551	h_{FE}	60 80 60 80 20 30	– – 250 250 – –	–
Collector – Emitter Saturation Voltage ($I_C = 10\text{ mA}$, $I_B = 1.0\text{ mA}$) ($I_C = 50\text{ mA}$, $I_B = 5.0\text{ mA}$)	Both Types MMBT5550 MMBT5551	$V_{CE(sat)}$	– – –	0.15 0.25 0.20	Vdc
Base – Emitter Saturation Voltage ($I_C = 10\text{ mA}$, $I_B = 1.0\text{ mA}$) ($I_C = 50\text{ mA}$, $I_B = 5.0\text{ mA}$)	Both Types MMBT5550 MMBT5551	$V_{BE(sat)}$	– – –	1.0 1.2 1.0	Vdc
Collector Emitter Cut-off ($V_{CB} = 10\text{ V}$) ($V_{CB} = 75\text{ V}$)	Both Types	I_{CES}	– –	50 100	nA

3. Pulse Test: Pulse Width = 300 μs , Duty Cycle = 2.0%.

MMBT5550LT1, MMBT5551LT1

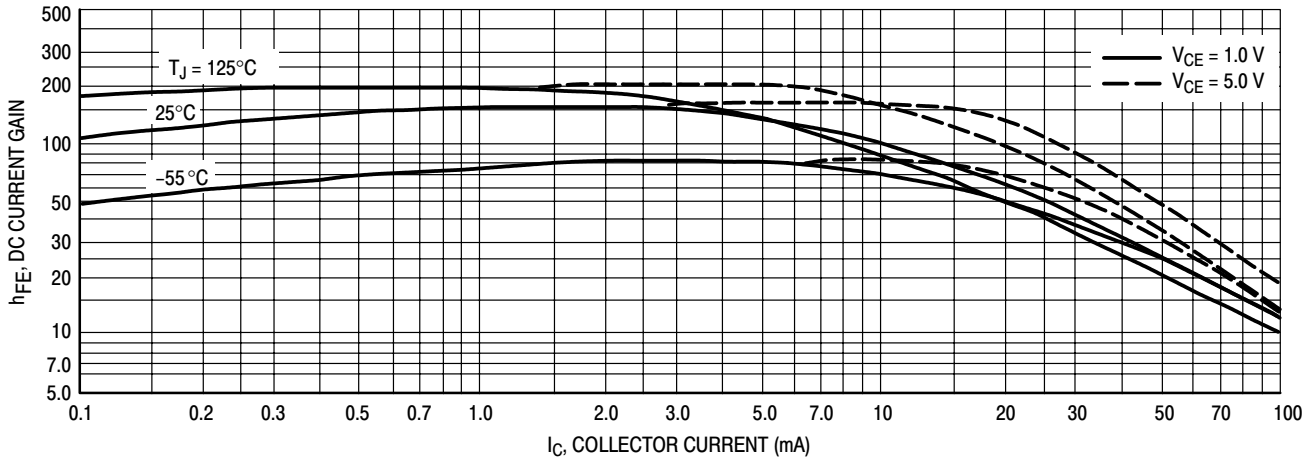

Figure 1. DC Current Gain

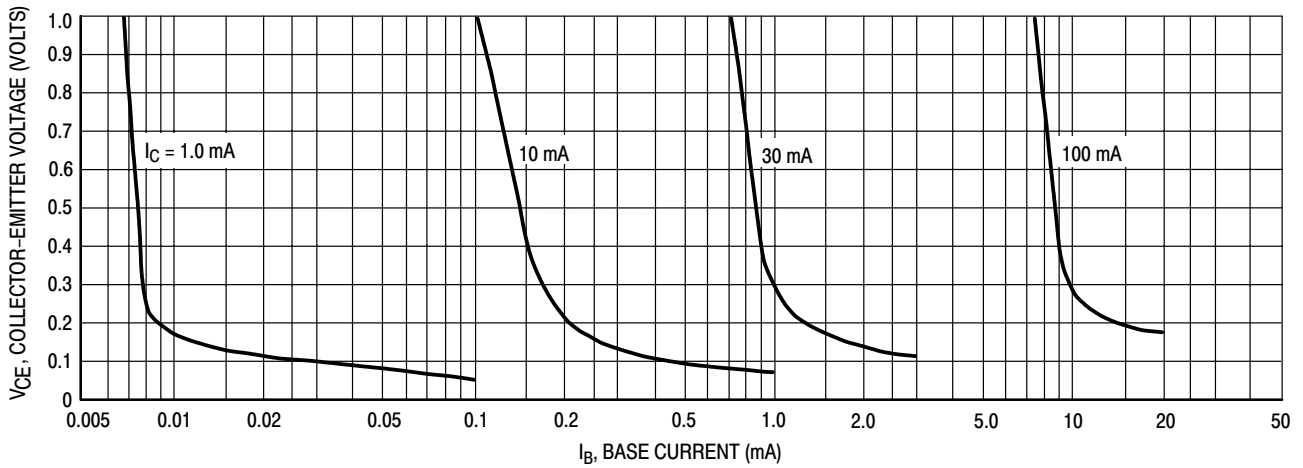

Figure 2. Collector Saturation Region

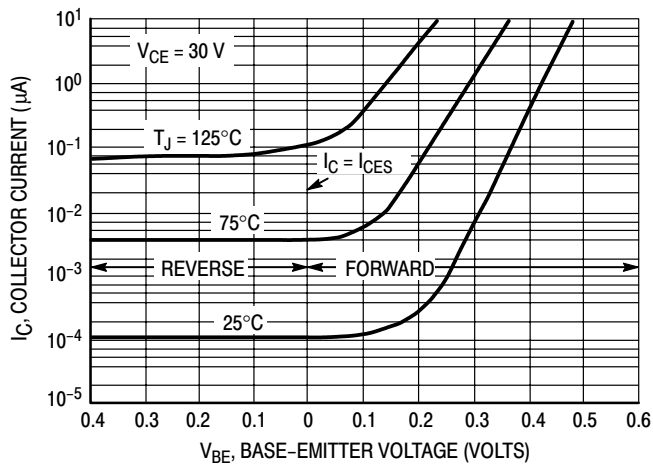

Figure 3. Collector Cut-Off Region

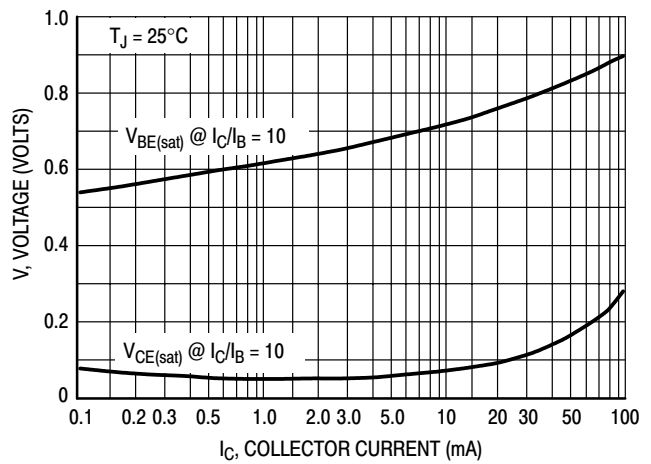

Figure 4. "On" Voltages

MMBT5550LT1, MMBT5551LT1

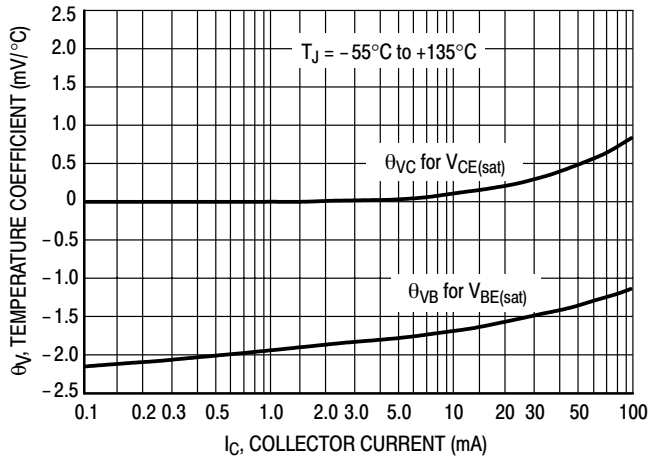
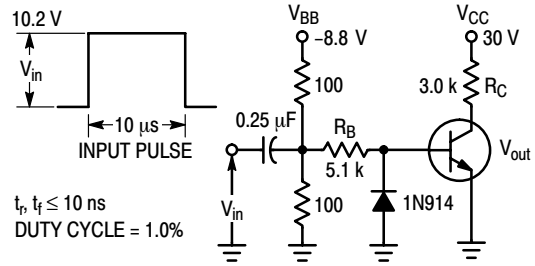

Figure 5. Temperature Coefficients



Values Shown are for $I_C @ 10\text{ mA}$

Figure 6. Switching Time Test Circuit

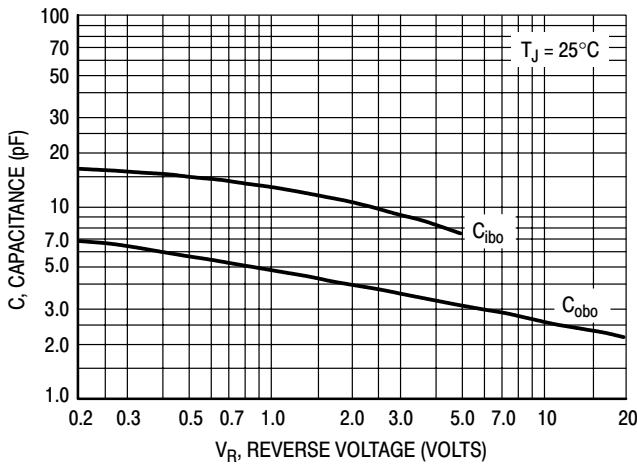

Figure 7. Capacitances

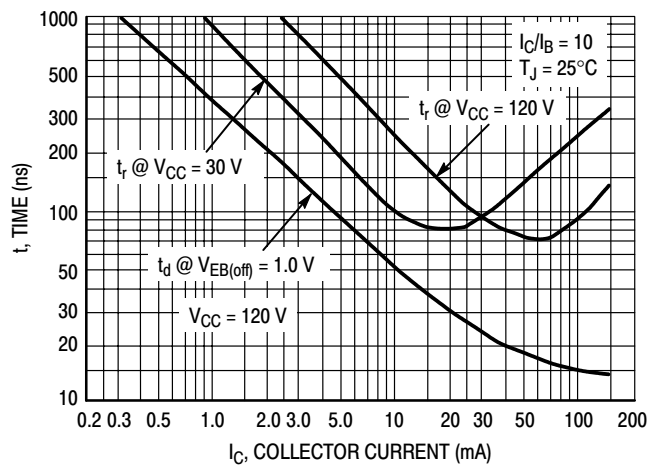

Figure 8. Turn-On Time

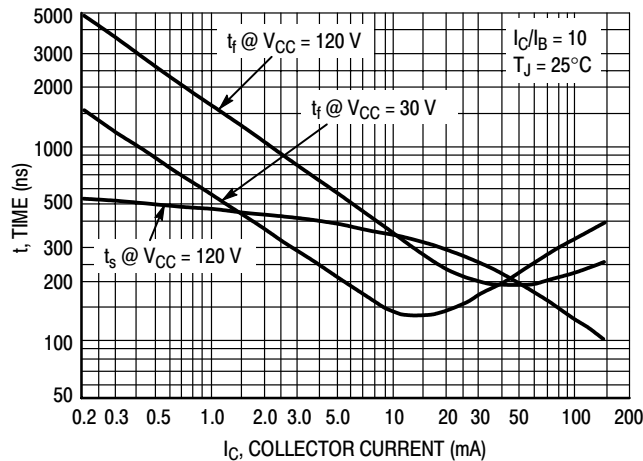
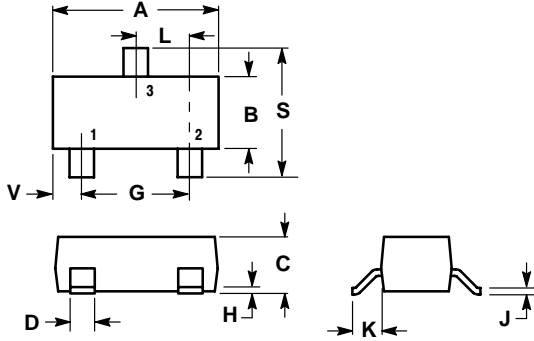

Figure 9. Turn-Off Time

MMBT5550LT1, MMBT5551LT1

PACKAGE DIMENSIONS

SOT-23-3 (TO-236)
CASE 318-08
ISSUE AK



- NOTES:
1. DIMENSIONING AND TOLERANCING PER ANSI Y14.5M, 1982.
 2. CONTROLLING DIMENSION: INCH.
 3. MAXIMUM LEAD THICKNESS INCLUDES LEAD FINISH THICKNESS. MINIMUM LEAD THICKNESS IS THE MINIMUM THICKNESS OF BASE MATERIAL.
 4. 318-01 THRU -07 AND -09 OBSOLETE, NEW STANDARD 318-08.

DIM	INCHES		MILLIMETERS	
	MIN	MAX	MIN	MAX
A	0.1102	0.1197	2.80	3.04
B	0.0472	0.0551	1.20	1.40
C	0.0350	0.0440	0.89	1.11
D	0.0150	0.0200	0.37	0.50
G	0.0701	0.0807	1.78	2.04
H	0.0005	0.0040	0.013	0.100
J	0.0034	0.0070	0.085	0.177
K	0.0140	0.0285	0.35	0.69
L	0.0350	0.0401	0.89	1.02
S	0.0830	0.1039	2.10	2.64
V	0.0177	0.0236	0.45	0.60

- STYLE 6:
PIN 1. BASE
2. EMITTER
3. COLLECTOR

SOLDERING FOOTPRINT*

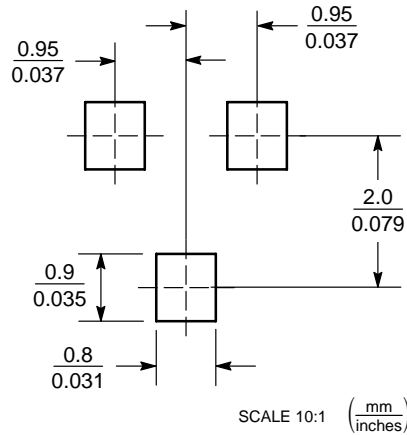

*For additional information on our Pb-Free strategy and soldering details, please download the ON Semiconductor Soldering and Mounting Techniques Reference Manual, SOLDERRM/D.

MMBT5550LT1, MMBT5551LT1

ON Semiconductor and  are registered trademarks of Semiconductor Components Industries, LLC (SCILLC). SCILLC reserves the right to make changes without further notice to any products herein. SCILLC makes no warranty, representation or guarantee regarding the suitability of its products for any particular purpose, nor does SCILLC assume any liability arising out of the application or use of any product or circuit, and specifically disclaims any and all liability, including without limitation special, consequential or incidental damages. "Typical" parameters which may be provided in SCILLC data sheets and/or specifications can and do vary in different applications and actual performance may vary over time. All operating parameters, including "Typicals" must be validated for each customer application by customer's technical experts. SCILLC does not convey any license under its patent rights nor the rights of others. SCILLC products are not designed, intended, or authorized for use as components in systems intended for surgical implant into the body, or other applications intended to support or sustain life, or for any other application in which the failure of the SCILLC product could create a situation where personal injury or death may occur. Should Buyer purchase or use SCILLC products for any such unintended or unauthorized application, Buyer shall indemnify and hold SCILLC and its officers, employees, subsidiaries, affiliates, and distributors harmless against all claims, costs, damages, and expenses, and reasonable attorney fees arising out of, directly or indirectly, any claim of personal injury or death associated with such unintended or unauthorized use, even if such claim alleges that SCILLC was negligent regarding the design or manufacture of the part. SCILLC is an Equal Opportunity/Affirmative Action Employer. This literature is subject to all applicable copyright laws and is not for resale in any manner.

PUBLICATION ORDERING INFORMATION

LITERATURE FULFILLMENT:

Literature Distribution Center for ON Semiconductor
P.O. Box 61312, Phoenix, Arizona 85082-1312 USA

Phone: 480-829-7710 or 800-344-3860 Toll Free USA/Canada

Fax: 480-829-7709 or 800-344-3867 Toll Free USA/Canada

Email: orderlit@onsemi.com

N. American Technical Support: 800-282-9855 Toll Free
USA/Canada

Japan: ON Semiconductor, Japan Customer Focus Center
2-9-1 Kamimeguro, Meguro-ku, Tokyo, Japan 153-0051
Phone: 81-3-5773-3850

ON Semiconductor Website: <http://onsemi.com>

Order Literature: <http://www.onsemi.com/litorder>

For additional information, please contact your
local Sales Representative.

MMBT5550LT1/D

This datasheet has been download from:

www.datasheetcatalog.com

Datasheets for electronics components.