

Keyes WS2812 8x4 Digit Full Color RGB LED Module

Module: MD0294

Instructions:

This product is an intelligent externally controlled LED light source. The shape of each LED is the same with a 5050 LED light bead and each component acts as a pixel. The pixel contains high-precision internal oscillator and 12V high voltage programmable constant current control segment, which ensures the colour consistence of pixel light.

Advantages:

The brightness of built-in IC light bead is higher than regular light bead. The built-in drive IC is of stable performance

Feature:

Intelligent anti reverse connection protection, the reverse connection of power wouldn't damage internal IC of LED;
 IC control circuit and LED light source share the same power source;
 Carries built-in signal shaping circuit;
 Carries built-in power-on reset and power-out reset;
 The tri-colour of each pixel can realise 256 level brightness display, it is able to display 16777216 kinds of colour, and the scan frequency is no lower than 400Hz/s;
 Serial cascade interface, which can realize data transceiver and decoding via only one signal cable;
 When refreshing rate is 30frame/s, the cascade number is not lower than 1024 point;
 The data transmission speed can reach up to 800Kbps;

Connection diagram:

VCC: connect to DC5V
 G: connect to GND
 DI: connect to data input
 DO: connect to data output

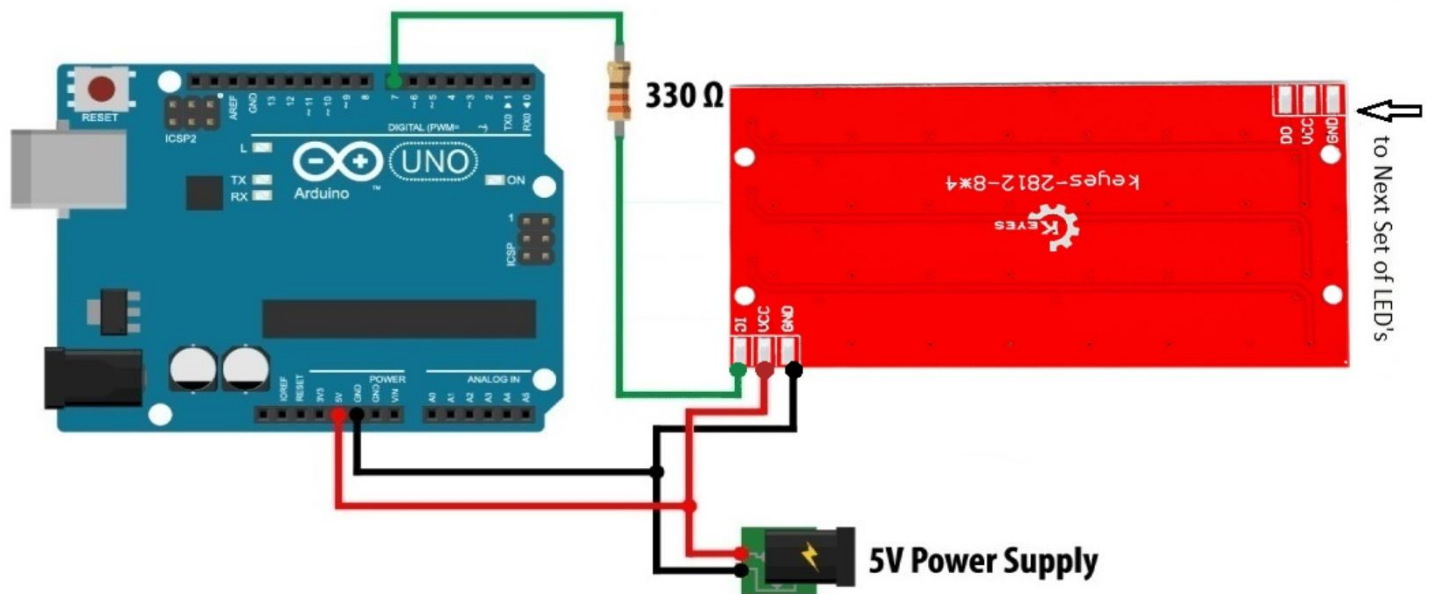

Download the example Code and library:

https://www.mantech.co.za/Datasheets/Products/MD0320_KEYESTUDIO.zip