

SUN™

LP60-010 PTC RESETTABLE OVERCURRENT PROTECTOR

APPLICATION:

Almost anywhere there is a low voltage power supply and a load to be protected including:

- DC MOTOR DRIVE CIRCUIT
- COMPUTERS & PERIPHERALS
- GENERAL ELECTRONICS EQUIPMENT
- AUTOMOTIVE APPLICATION

PRODUCT DIMENSIONS PACKAGE: 1

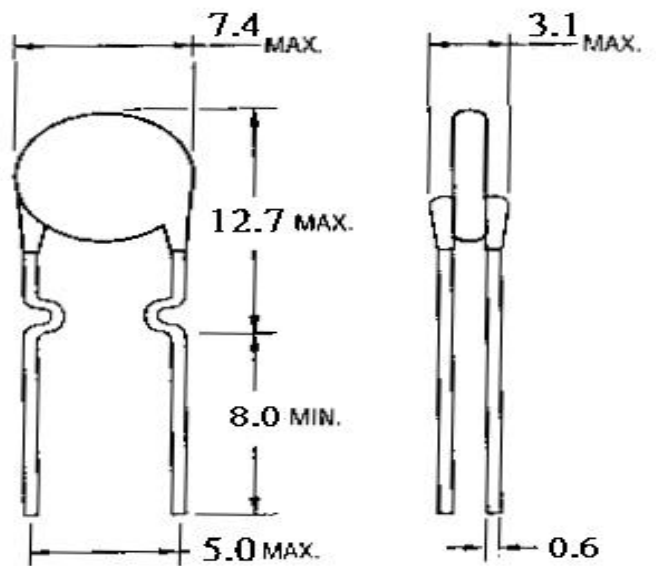

DIMENSIONS: mm

ELECTRICAL CHARACTERISTICS:

- I_{max} 40A
- V_{max} 60VOLTS
- I_{hold} 0.1A max @ 23
- I_{trip} 0.2A min @ 23

RESISTANCE

- $R_{initial}$ 2.5 OHM MIN
4.5 OHM MAX
- Time to trip 4.0 SEC
- P_D 0.4W

NOTE:

Measured Values

* DIRECT REPLACE: BOURNS MF-R010
: RAYCHEM RXE010

I_H – Hold current	Maximum current device will pass without interruption in 23 still air.
I_T – Trip current	Min. current which will switch the device from low to high resistance in 23 still air.
I_{max}	Maximum fault current the device can withstand without damage at rated voltage.
V_{max}	Maximum voltage the device can withstand without damage at rated current.
P_D	Power dissipated from the device when in the tripped state in 23 still air.
Initial Resistance	Device resistance as received from the factory.

MOBICON GROUP