

60W, AC/DC converter



UL US CE RoHS

FEATURES

- Wide input voltage range: 90~264VAC/122~370VDC
- Low standby power consumption: 0.5W, conversion efficiency up to 86%, high isolation voltage up to 4K VAC
- Output short circuit, over-current, over-voltage protections
- Meets IEC61000, UL60950, EN60950 standards
- Mounting: PCB mounting, Chassis mounting, DIN-Rail mounting available

LH60-20Bxx(-DT) series are 60W efficient environmental-protection AC-DC module power supplies which have advantages of high surge resistance, high efficiency, high reliability, low power consumption and high safety isolation, etc. The series products are widely used in industrial control and other power industries.

Note: Please refer to Design Reference when module being used in a bad EMC environment.

Selection Guide

Certification	Part No.*	Output Power	Nominal Output Voltage and Current(Vo/Io)	Efficiency (230VAC, %/Typ.)	Max. Capacitive Load (μF)			
UL/CE	LH60-20B05	50W	5V/10A	82	80000			
	LH60-20B05-DT							
	LH60-20B09	60W	9V/6.6A	84	28000			
	LH60-20B09-DT							
	LH60-20B12					12V/5A	86	14000
	LH60-20B12-DT							
	LH60-20B15					15V/4A	86	12000
	LH60-20B24					24V/2.5A	86	4000
LH60-20B48	48V/1.25A	86	1000					

Note: 1.*LH60-20Bxx-DT series has no input under-voltage protection.

2.*Part No. with a suffix of "A5" means chassis mounting and that with a suffix of "A6" means DIN-Rail mounting (e.g. LH60-20B05A5 means chassis mounting; LH60-20B05A6 means DIN-Rail mounting).

Input Specifications



Item	Operating Conditions	Min.	Typ.	Max.	Unit	
Input Voltage Range	AC input	90	--	264	VAC	
	DC input	122	--	370	VDC	
Input Frequency		47	--	63	Hz	
Input Current	115VAC	--	--	1.4	A	
	230VAC	--	--	0.7		
Inrush Current	115VAC	--	30	--	A	
	230VAC	--	50	--		
Input Under-voltage Protection	Start-up Voltage	AC input	65	--	90	VAC
		DC input	92	--	122	VDC
	Shutdown Voltage	AC input	55	--	75	VAC
		DC input	79	--	105	VDC
Hot Plug		Unavailable				

Output Specifications

Item	Operating Conditions	Min.	Typ.	Max.	Unit
Output Voltage Accuracy		--	±2	--	%
Line Regulation	Full load	--	±0.5	--	
Load Regulation	5%-100% load	--	±1	--	
Ripple & Noise*	20MHz bandwidth (peak-peak value)	--	--	150	mV
Temperature Coefficient		--	±0.02	--	%/°C
Stand-by Power Consumption		--	--	0.5	W
Short Circuit Protection		Continuous, self-recovery			
Over-current Protection		≥110%Io self-recovery			
Over-voltage Protection	5V Output	--	--	9	V
	9V Output	--	--	16	
	12V Output	--	--	16	
	15V Output	--	--	24	
	24V Output	--	--	35	
	48V Output	--	--	63	
Min. Load		0	--	--	%
Trim		--	--	±10	
Hold-up Time	115VAC input	--	15	--	ms
	230VAC input	--	80	--	

Note: * Ripple and noise are measured by "parallel cable" method, please see AC-DC Converter Application Notes for specific operation.

General Specifications

Item	Operating Conditions	Min.	Typ.	Max.	Unit
Isolation Voltage	Input-output	4000	--	--	VAC
	Input- 	1500	--	--	
	Output- 	500	--	--	
Operating Temperature		-40	--	+70	°C
Storage Temperature		-40	--	+85	
Storage Humidity		--	--	95	%RH
Welding Temperature	Wave-soldering	260±5°C; time:5~10s			
	Manual-welding	360±10°C; time:3~5s			
Switching Frequency		--	100	--	KHz
Power Derating	-40°C to -30°C	4.0	--	--	%/°C
	+45°C to +70°C (5V, 9V output)	3.0	--	--	
	+50°C to +70°C (12V, 15V output)	2.5	--	--	
	+55°C to +70°C (24V, 48V output)				
Safety Standard		IEC60950/EN60950/UL60950			
Safety Certification		EN60950/UL60950			
Safety Class		CLASS I			
MTBF		MIL-HDBK-217F@25°C > 300,000 h			

Physical Specifications

Casing Material	Black flame-retardant and heat-resistant plastic (UL94-V0)				
Dimension	Horizontal package	109.00*58.50*30.00 mm			
	A5 chassis mounting	135.00*70.00*38.50 mm			
	A6 Din-Rail mounting	137.00*70.00*44.00 mm			
Weight	Horizontal package/A5 chassis mounting/A6 Din-Rail mounting				310g/400g /470g (Typ.)
Cooling Method	Free convection				

EMC Specifications

EMI	CE	CISPR22/EN55022, CLASS B	
	RE	CISPR22/EN55022, CLASS B	
EMS	ESD	IEC/EN61000-4-2	±6KV/8KV Perf. Criteria B
	RS	IEC/EN61000-4-3	10V/m perf. Criteria A
	EFT	IEC/EN61000-4-4	±4KV perf. Criteria B
	Surge	IEC/EN61000-4-5	±2KV/4KV perf. Criteria B
		IEC/EN61000-4-5	±4KV/6KV (See Fig. 2 for recommended circuit) perf. Criteria B
	CS	IEC/EN61000-4-6	10 Vr.m.s perf. Criteria A
	PFM	IEC/EN61000-4-8	10A/m perf. Criteria A
	Voltage dips, short interruptions and voltage variations immunity		IEC/EN61000-4-11

Product Characteristic Curve

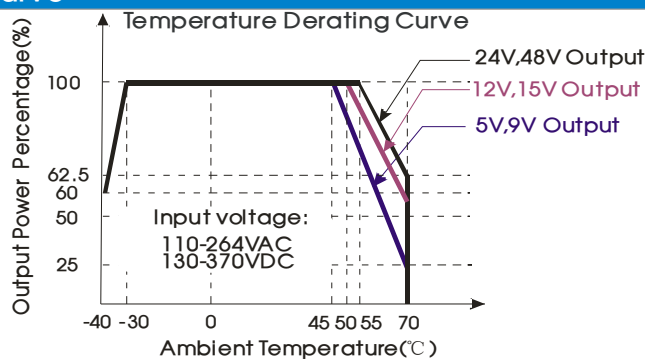

Note: ① Input voltage should be derated based on temperature derating when it is 55~110VAC/77~130VDC;

② This product is suitable for use in natural air cooling environments, if in a closed environment, please contact our company's FAE.

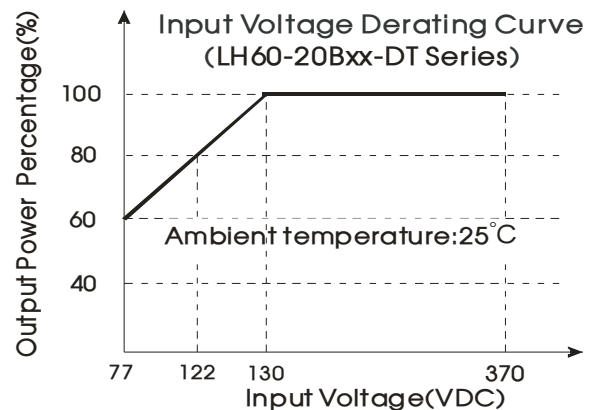
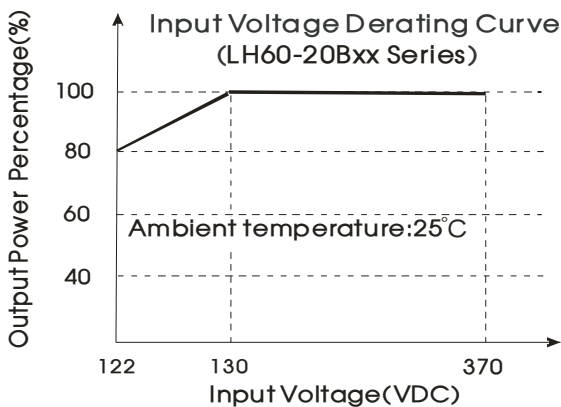
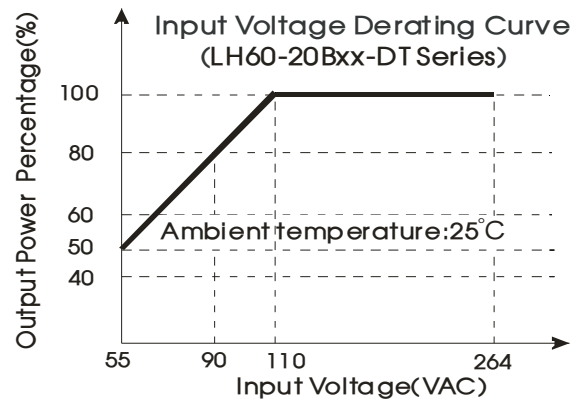
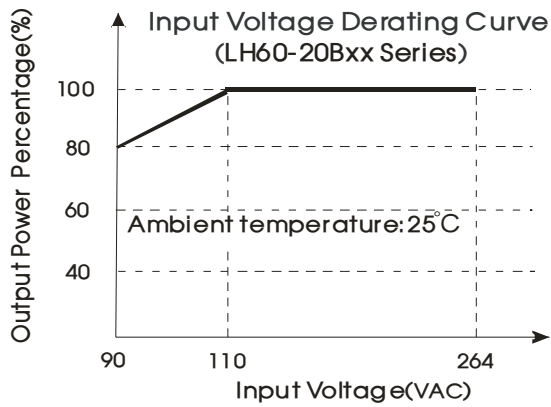

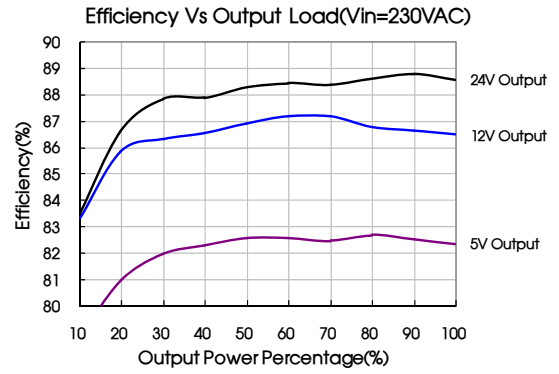
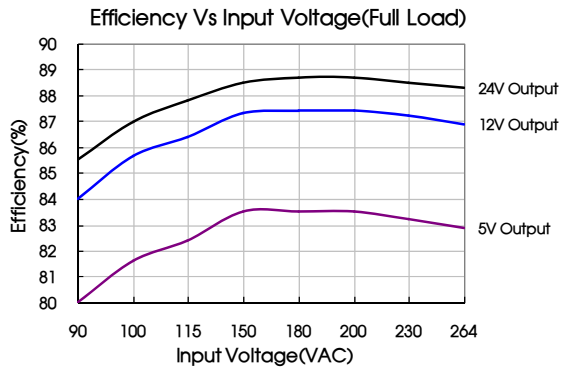

Design Reference

1. Typical application circuit

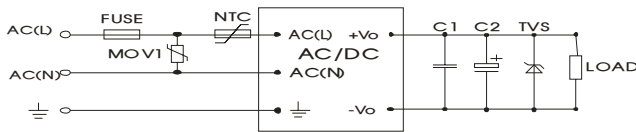

Fig. 1

Model	C1(μF)	C2(μF)	TVS tube
LH60-20B05(-DT)	1	680	SMBJ7.0A
LH60-20B09(-DT)		470	SMBJ12A
LH60-20B12(-DT)		330	SMBJ20A
LH60-20B15		330	SMBJ20A
LH60-20B24		200	SMBJ30A
LH60-20B48		100	SMBJ64A

Note: Output filtering capacitor C2 is electrolytic capacitor, it is recommended to use high frequency and low impedance electrolytic capacitor. For capacitance and current of capacitor please refer to manufacture's datasheet. Capacitor withstand voltage derating should be 80% or above. C1 is ceramic capacitor, which is used to filter high-frequency noise. TVS is a recommended component to protect post-circuits if converter fails. External input FUSE model is recommended to use 3.15A/250VAC, slow fusing. External input NTC model is recommended to use 5D-9. External input MOV model is recommended to use S14K350.

2. EMC solution-recommended circuit

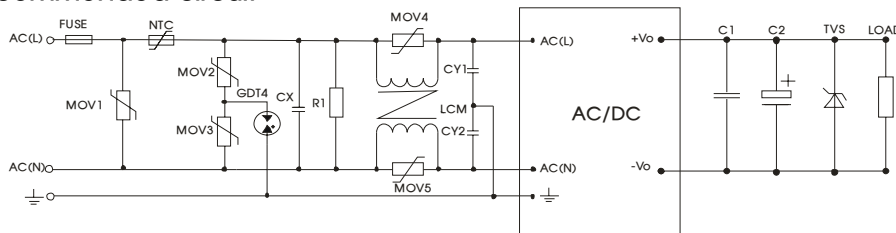

Fig 2

(Output external circuit refer to the typical application circuit)

EMC solution-recommended circuit PCB layout

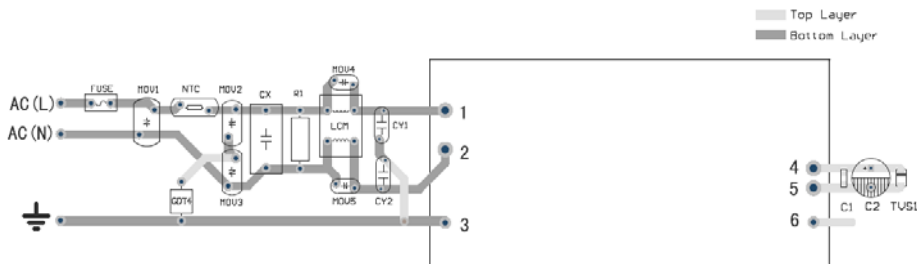
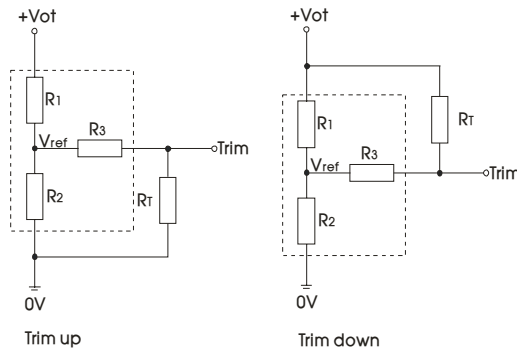

Fig 3

Note: Suggestions for safety regulation and wiring width: wire width $\geq 3\text{mm}$, distance between wires $\geq 6\text{mm}$, and distance between wire and ground $\geq 6\text{mm}$

Element model	Recommended value	Element model	Recommended value
MOV1	S20K350	CY2	2.2nF /400VAC
MOV2	S14K350	R1	1MΩ/2W
MOV3	S14K350	LCM	2.2 mH, recommended to use MORNSUN's FL2D-30-222;
MOV4	S10K350	GDT4	B5G3600
MOV5	S10K350	NTC	5D-14
CX	0.15μF/300VAC	FUSE	3.15A/250V, slow fusing, necessary
CY1	2.2nF/400VAC	--	--

3. Application of Trim and calculation of Trim resistance



Applied circuits of Trim (Part in broken line is the interior of models)

Calculation formula of Trim resistance:

$$\begin{aligned} \text{up: } R_T &= \frac{\alpha R_2}{R_2 - \alpha} \cdot R_3 & \alpha &= \frac{V_{ref}}{V_{ot} - V_{ref}} \cdot R_1 \\ \text{down: } R_T &= \frac{\alpha R_1}{R_1 - \alpha} \cdot R_3 & \alpha &= \frac{V_{ot} - V_{ref}}{V_{ref}} \cdot R_2 \end{aligned}$$

R_T is Trim resistance
 α is a self-defined parameter, with no real meaning.

Vout	R1(KΩ)	R2(KΩ)	R3(KΩ)	Vref(V)	Vot(V)
5V	3.3	3.3	1	2.5	Output voltage after regulation, variation ≤ ±10%
9V	4.7	1.8	1	2.5	
12V	3.83	1	1	2.5	
15V	7.5	1.5	1	2.5	
24V	8.66	1	1	2.5	
48V	33	1.8	1	2.5	

4. For more information about Mornsun EMC Filter products, please visit www.mornsun-power.com to download the Selection Guide of EMC Filter

Dimensions and Recommended Layout

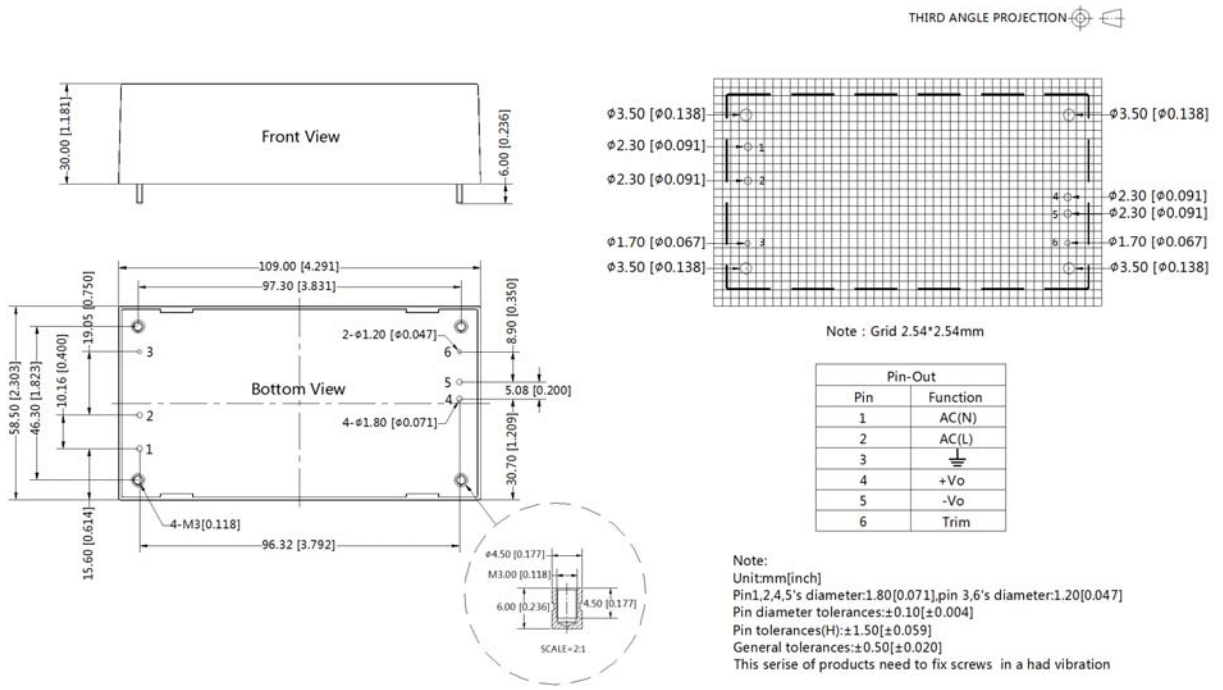

1104003101-80

A5 Chassis mounting Dimensions

THIRD ANGLE PROJECTION 

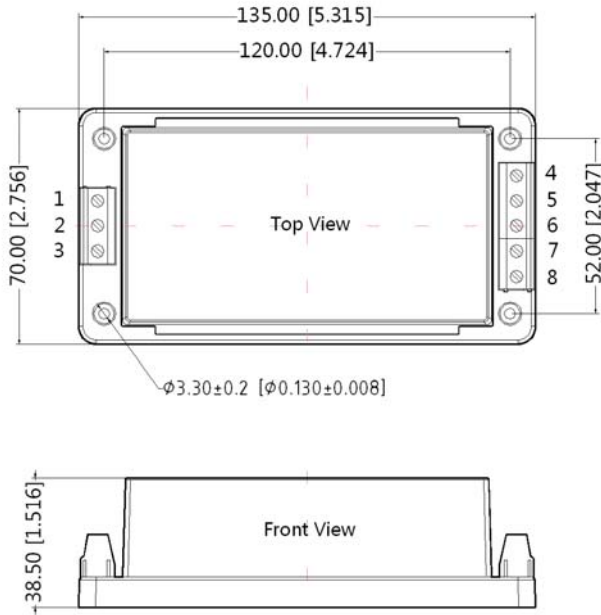

Pin-Out	
Pin	Function
1	AC(N)
2	AC(L)
3	⏏
4	NC
5	NC
6	+Vo
7	-Vo
8	Trim

Note:
Unit:mm[inch]
Wire range:24~12 AWG
General tolerances:±1.00[±0.040]

1104006602-A0

A6 Din-Rail mounting Dimensions

THIRD ANGLE PROJECTION 

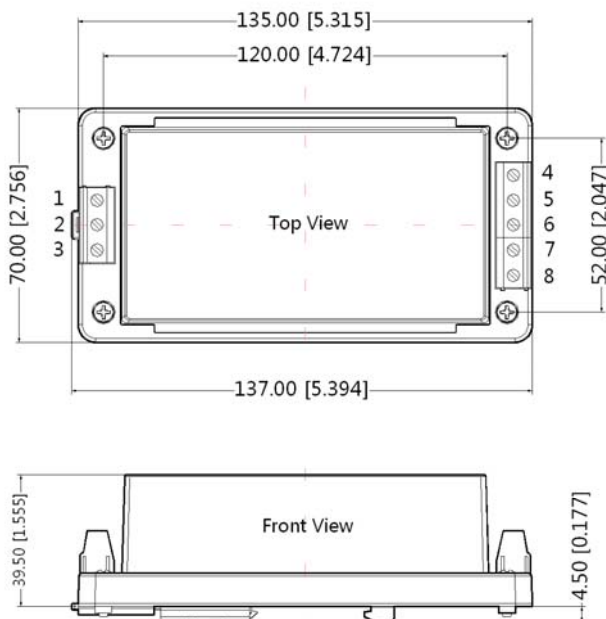

Pin-Out	
Pin	Function
1	AC(N)
2	AC(L)
3	⏏
4	NC
5	NC
6	+Vo
7	-Vo
8	Trim

Note:
Unit:mm[inch]
Installed on DIN RAIL TS35
Wire range:24~12 AWG
General tolerances:±1.00[±0.040]

1104006601-A0

Notes:

1. Packing information please refer to Product Packing Information which can be downloaded from www.mornsun-power.com. Packing bag number: 58220020(Horizontal package), 58220031(A5/A6 package);
2. If the product is not operated within the required load range, the product performance cannot be guaranteed to comply with all parameters in the datasheet;
3. Unless otherwise specified, parameters in this datasheet were measured under the conditions of $T_a=25\text{ }^{\circ}\text{C}$, humidity<75% with nominal input voltage and rated output load;
4. All index testing methods in this datasheet are based on our Company's corporate standards;
5. The performance parameters of the product models listed in this manual are as above, but some parameters of non-standard model products may exceed the requirements mentioned above. Please contact our technicians directly for specific information;
6. We can provide product customization service;
7. Specifications are subject to change without prior notice.

MORNSUN Guangzhou Science & Technology Co., Ltd.

Address: No. 5, Kehui St. 1, Kehui Development Center, Science Ave., Guangzhou Science City, Luogang District, Guangzhou, P. R. China
Tel: 86-20-38601850-8801 Fax: 86-20-38601272 E-mail: info@mornsun.cn