

25W, AC/DC converter

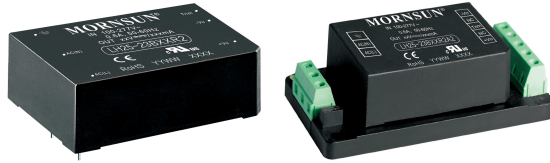

CB Report

RoHS



UL62368-1 EN62368-1

LH25-23BxxR2 series AC-DC converters are highly efficient, environmental-friendly 25W power modules. It features universal AC input and at the same time accepts DC input voltage, low power consumption, high efficiency, high reliability, reinforced isolation. It offers good EMC performance compliant to IEC/EN61000-4 and CISPR32/EN55032 and meets IEC/EN/UL62368 standards. The converters are widely used in industrial, power and office applications. For extremely harsh EMC environment, we recommend using the application circuit show in Design Reference of this datasheet.

## FEATURES

- Universal 85-305VAC or 100-430VDC input voltage
- Operating ambient temperature range: -40°C to +85°C
- High I/O isolation test voltage up to 4200VAC
- Up to 87% efficiency
- Output short circuit, over-current, over-voltage protection
- 5000m altitude application
- Plastic case meets UL94V-0 flammability
- Meets Emissions CLASS B and surge  $\pm 2KV/\pm 4KV$  without additional circuits
- Over-voltage category OVC III (meet IEC62477-1) (2000m altitude)

## Selection Guide

Certification	Part No.*	Output Power	Nominal Output Voltage and Current (Vo/Io)	Efficiency at 230VAC (%) Typ.	Capacitive Load (uF) Max.
EN	LH25-23B03R2	13.53W	3.3VDC/4100mA	78	48000
	LH25-23B05R2	20.5W	5VDC/4100mA	82	12240
UL/EN/IEC	LH25-23B09R2	22.5W	9VDC/2500mA	82	5600
	LH25-23B12R2	25.2W	12VDC/2100mA	84	5400
EN	LH25-23B15R2	24W	15VDC/1600mA	85	2400
	LH25-23B24R2	26.4W	24VDC/1100mA	85	1440
	LH25-23B48R2	24W	48VDC/500mA	87	600

Note: \* Use suffix "A2" for chassis mounting and suffix "A4" for Din-Rail mounting.

## Input Specifications

Item	Operating Conditions	Min.	Typ.	Max.	Unit
Input Voltage Range	AC input	85	--	305	VAC
	DC input	100	--	430	VDC
Input Frequency		47	--	63	Hz
Input Current	115VAC	--	--	0.6	A
	230VAC	--	--	0.34	
Inrush Current	115VAC	--	20	--	A
	230VAC	--	40	--	
Leakage Current	277VAC/50Hz	0.25mA RMS Max.			
Recommended External Input Fuse		3.15A/300V, slow-blow, required			
Hot Plug		Unavailable			

## Output Specifications

Item	Operating Conditions	Min.	Typ.	Max.	Unit
Output Voltage Accuracy	3.3V output	--	$\pm 3$	--	%
	others	--	$\pm 2$	--	
Line Regulation	Rated load	--	$\pm 0.5$	--	%
Load Regulation	0% - 100% load	--	$\pm 1$	--	
Ripple & Noise*	20MHz bandwidth (peak-to-peak value)	--	50	100	mV

Temperature Coefficient		--	±0.02	--	%/°C
Stand-by Power Consumption	230VAC	3.3V/5V/9V/12V/15V/24V	--	0.3	W
		48V	--	0.4	
Short Circuit Protection		Hiccup, continuous, self-recovery			
Over-current Protection		≥150%, self-recovery			
Over-voltage Protection	3.3V/5V output	≤7.5VDC (Hiccup)			
	9V output	≤15VDC (Hiccup)			
	12V/15V output	≤20VDC (Hiccup)			
	24V output	≤30VDC (Hiccup)			
	48V output	≤60VDC (Hiccup)			
Minimum Load		0	--	--	%
Hold-up Time	115VAC input	--	10	--	ms
	230VAC input	--	60	--	
Adjustable Output Voltage (Trim)		±10%Vo			
Note: * The "parallel cable" method is used for ripple and noise test, please refer to AC-DC Converter Application Notes for specific information.					

## General Specifications

Item	Operating Conditions	Min.	Typ.	Max.	Unit
Isolation	Input - output	4200	--	--	VAC
	Input - PE	2500	--	--	
	Output - PE	1250	--	--	
Impulse Withstand Voltage	Input - output	6000	--	--	VDC
	Input - PE	6000	--	--	
	Output - PE	6000	--	--	
Insulation Resistance	Input - output	100	--	--	MΩ
	Input - PE	100	--	--	
	Output - PE	100	--	--	
Operating Temperature		-40	--	+85	°C
Storage Temperature		-40	--	+105	
Storage Humidity		--	--	95	%RH
Soldering Temperature	Wave-soldering	260 ± 5°C; time: 5 - 10s			
	Manual-welding	360 ± 10°C; time: 3 - 5s			
Switching Frequency		--	65	--	kHz
Power Derating	-40°C to -25°C	3.33	--	--	% / °C
	+50°C to +70°C	2.5	--	--	
	+70°C to +85°C	0.67	--	--	
	85VAC - 100VAC	1.00	--	--	% / VAC
	277VAC - 305VAC	0.715	--	--	
2000m - 5000m	6.67	--	--	% / Km	
Safety Standard	9V/12V output	IEC/UL62368-1 & EN62368-1 (Report); Design refer to IEC62477-1			
	Others	EN62368-1 (Report); Design refer to IEC/UL62368-1, IEC62477-1			
Safety Class		CLASS I			
MTBF		MIL-HDBK-217F@25°C > 300,000 h			

## Mechanical Specifications

Case Material	Black plastic, flame-retardant and heat-resistant (UL94V-0)				
Dimension	Horizontal package	70.00 x 48.00 x 23.50 mm			
	A2 chassis package	96.10 x 54.00 x 32.00mm			
	A4 DIN-rail package	96.10 x 54.00 x 36.60mm			
Weight	Horizontal package/A2 chassis package/A4 DIN-rail package	120g (Typ.)/170g (Typ.)/210g (Typ.)			
Cooling Method	Free air convection				

Electromagnetic Compatibility (EMC)

Emissions	CE	CISPR32/EN55032	CLASS B	
	RE	CISPR32/EN55032	CLASS B	
Immunity	ESD	IEC/EN61000-4-2	Contact $\pm 8KV$ /Air $\pm 15KV$	Perf. Criteria A
	RS	IEC/EN61000-4-3	10V/m	perf. Criteria A
	EFT	IEC/EN61000-4-4	$\pm 4KV$	perf. Criteria A
	Surge	IEC/EN61000-4-5	line to line $\pm 2KV$ / line to ground $\pm 4KV$	perf. Criteria A
		IEC/EN61000-4-5	line to line $\pm 4KV$ / line to ground $\pm 6KV$ (See Fig. 2 for recommended circuit)	perf. Criteria A
	CS	IEC/EN61000-4-6	10Vr.m.s	perf. Criteria A
Voltage dip, short interruption and voltage variation	IEC/EN61000-4-11	0%, 70%	perf. Criteria B	

Product Characteristic Curve

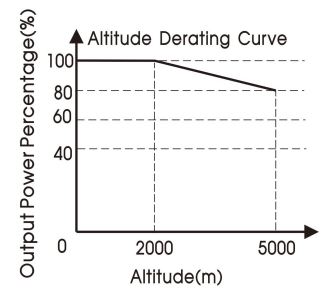
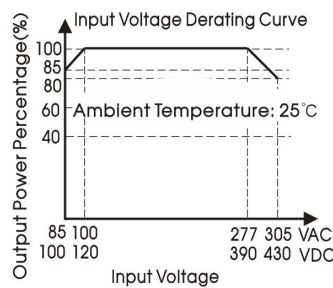
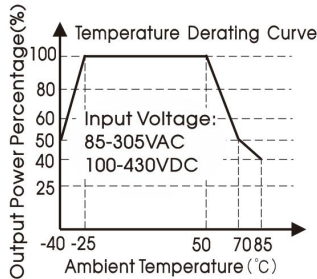

Note: ① With an AC input between 85 - 100VAC/277 - 305VAC and a DC input between 100 - 120VDC/390 - 430VDC, the output power must be derated as per temperature derating curves;

② This product is suitable for applications using natural air cooling; for applications in closed environment please consult factory or one of our FAE.

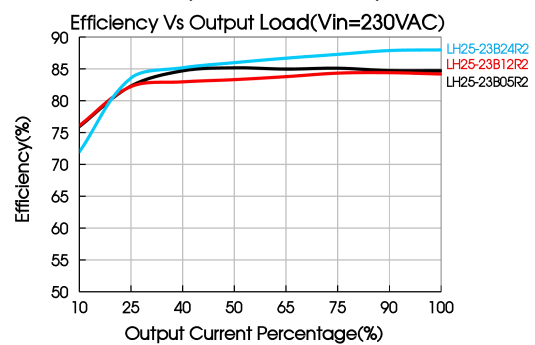
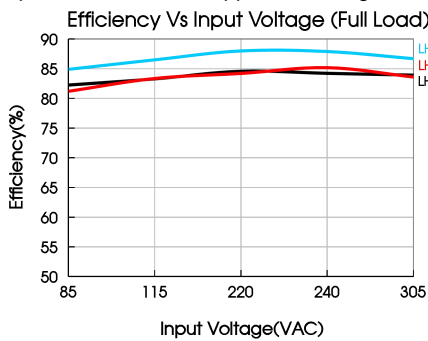

Design Reference

1. Typical application

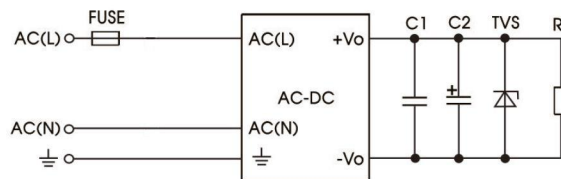

Fig. 1: Typical circuit diagram

Part No.	C1	C2	FUSE	TVS
LH25-23B03R2	1uF/50V	330uF/16V	3.15A/300V, slow-blow, required	SMBJ7.0A
LH25-23B05R2		330uF/16V		SMBJ7.0A
LH25-23B09R2		330uF/16V		SMBJ12A
LH25-23B12R2		330uF/25V		SMBJ20A
LH25-23B15R2		330uF/25V		SMBJ20A
LH25-23B24R2		120uF/35V		SMBJ30A
LH25-23B48R2		68uF/63V		SMBJ64A

Output Filter Components:

We recommend using an electrolytic capacitor with high frequency, and low ESR rating for C2 (refer to manufacture's datasheet). Choose a Capacitor voltage rating with at least 20% margin, in other words not exceeding 80%. C1 is a ceramic capacitor used for filtering high-frequency noise and TVS is a recommended suppressor diode to protect the application in case of a converter failure.

2. EMC compliance recommended circuit

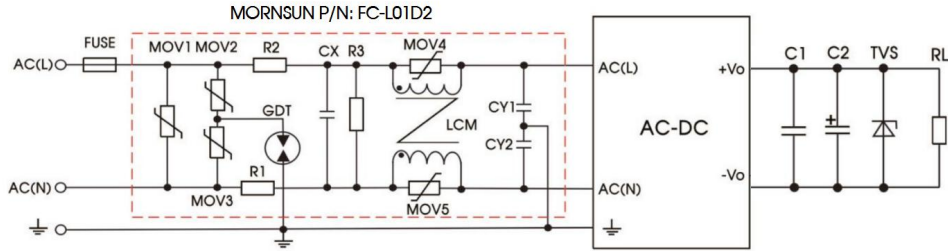
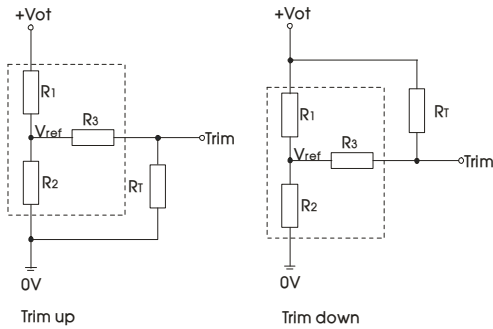

Fig 2: EMC application circuit with higher requirements

Component	Recommended value	Component	Recommended value
MOV1	S20K350	CY1/CY2	2200pF/400VAC
MOV2/MOV3	S14K350	GDT	B 5G3600
MOV4/MOV5	S07K350	R3	1MΩ/2W (wire-wound resistor, required)
CX	0.15uF/310VAC	FUSE	6.3A/300V, slow-blow, required
R1/R2	2Ω /3W (wire-wound resistor, required)		
LCM	10mH, we recommended using part no. FL2D-Z5-153 (MORNSUN)		

Note: R3 (required) can also be replaced by 4 pieces of 1.5MΩ /1206 patch resistors in series and parallel.

3. Trim Function for Output Voltage Adjustment (open if unused)



Calculation formula of Trim resistance:

$$\text{up: } R_T = \frac{\alpha R_2}{R_2 - \alpha} - R_3 \quad \alpha = \frac{V_{ref}}{V_{ot} - V_{ref}} \cdot R_1$$

$$\text{down: } R_T = \frac{\alpha R_1}{R_1 - \alpha} - R_3 \quad \alpha = \frac{V_{ot} - V_{ref}}{V_{ref}} \cdot R_2$$

RT = Trim Resistor value;  
α = Self-defined parameter;

Trim resistor connection (dashed line shows internal resistor network)

Vout	R1(KΩ)	R2(KΩ)	R3(KΩ)	Vref(V)	Vot(V)
3.3V	7.5	4.45	1	1.24	Output voltage after regulation, variation ≤ ±10%
5V	7.5	7.33	1	2.5	
9V	12.4	4.75	1	2.5	
12V	24	6.28	1	2.5	
15V	20	3.96	1	2.5	
24V	24	2.76	1	2.5	
48V	27	1.47	1	2.5	

4. For additional information please refer to application notes on [www.mornsun-power.com](http://www.mornsun-power.com)

Dimensions and Recommended Layout

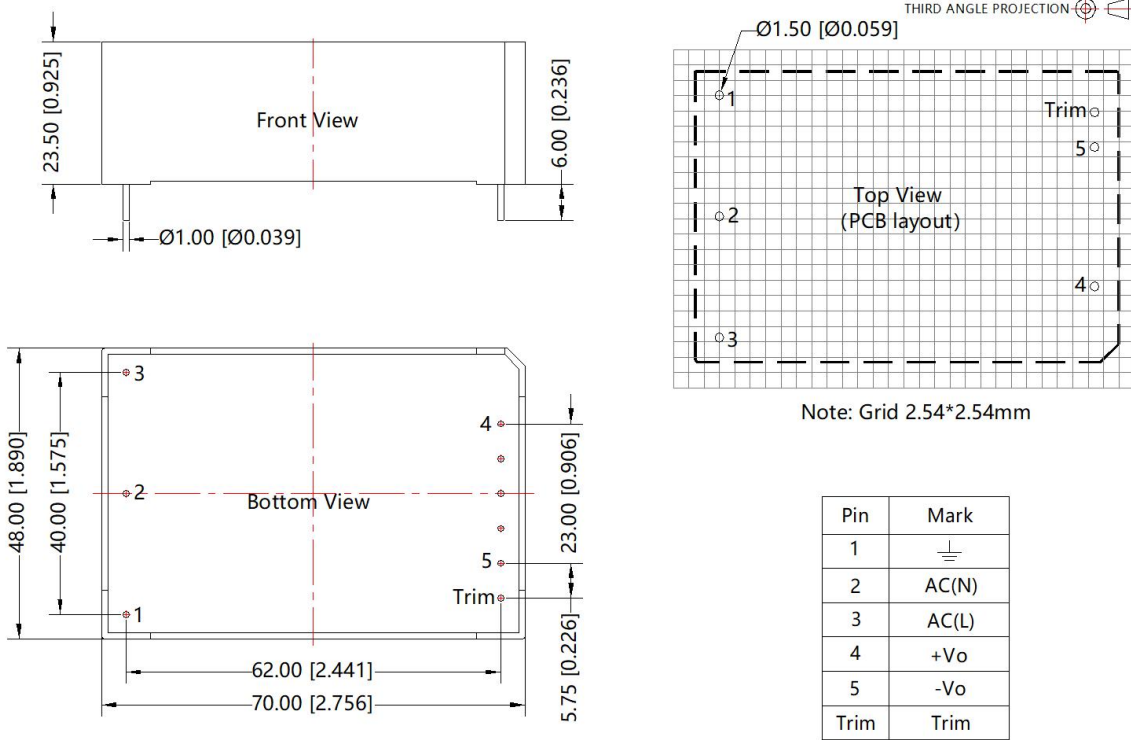

Note:  
Unit: mm[inch]  
Pin diameter tolerances:  $\pm 0.10[\pm 0.004]$   
General tolerances:  $\pm 0.50[\pm 0.020]$

A2 Dimensions

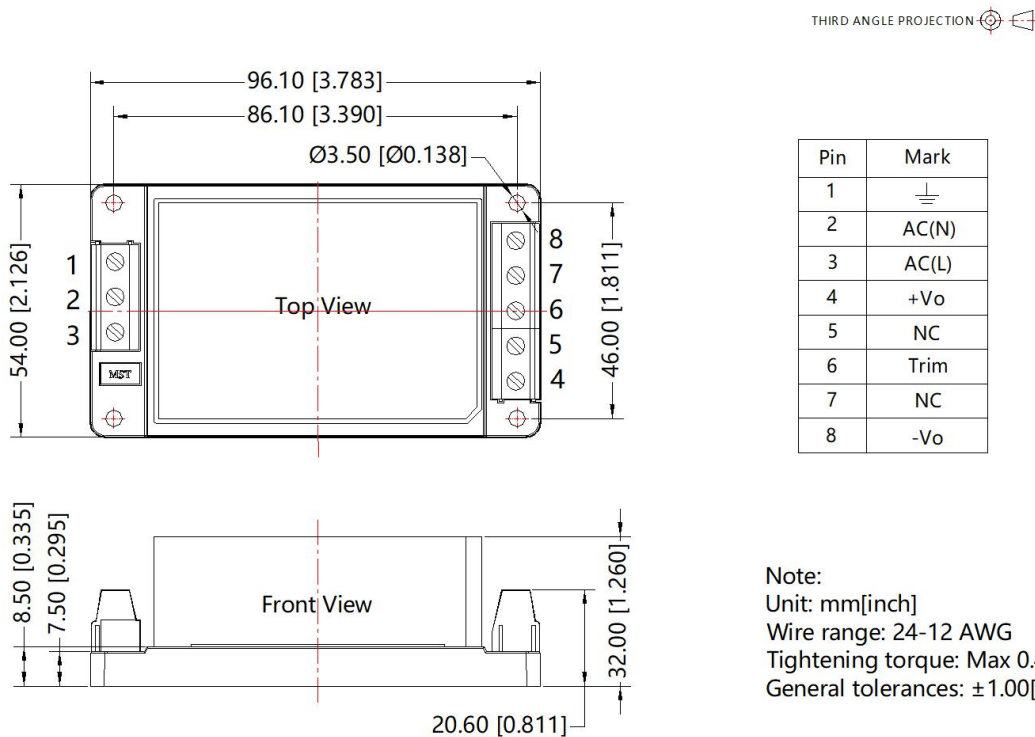

A4 Dimensions

THIRD ANGLE PROJECTION 

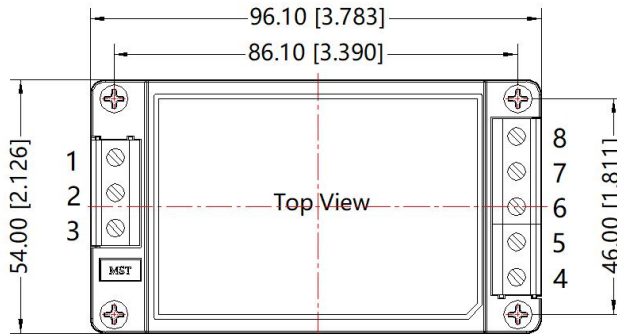

Pin	Mark
1	
2	AC(N)
3	AC(L)
4	+Vo
5	NC
6	Trim
7	NC
8	-Vo

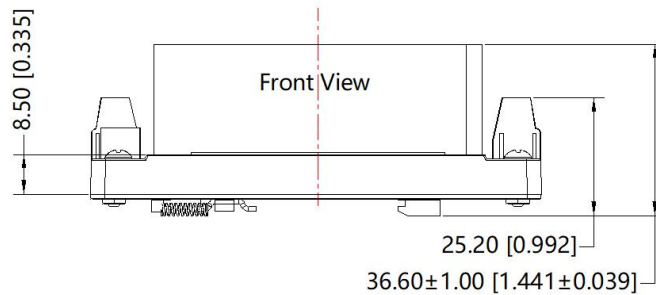

Note:

Unit: mm[inch]

Mounting rail: TS35, rail needs to

connect safety ground

Wire range: 24-12 AWG

Tightening torque: Max 0.4 N·m

General tolerances: ± 1.00[±0.039]

Note:

1. For additional information on Product Packaging please refer to [www.mornsun-power.com](http://www.mornsun-power.com). Packaging bag number : 58220006 (Horizontal package); 58220019 (A2/A4 package);
2. Unless otherwise specified, parameters in this datasheet were measured under the conditions of  $T_a=25^{\circ}\text{C}$ , humidity<75% with nominal input voltage and rated output load;
3. All index testing methods in this datasheet are based on our company corporate standards;
4. We can provide product customization service, please contact our technicians directly for specific information;
5. Products are related to laws and regulations: see "Features" and "EMC";
6. Our products shall be classified according to ISO14001 and related environmental laws and regulations, and shall be handled by qualified units.

Mornsun Guangzhou Science & Technology Co., Ltd.

Address: No. 5, Kehui St. 1, Kehui Development Center, Science Ave., Guangzhou Science City, Huangpu District, Guangzhou, P. R. China

Tel: 86-20-38601850

Fax: 86-20-38601272

E-mail: [info@mornsun.cn](mailto:info@mornsun.cn)

[www.mornsun-power.com](http://www.mornsun-power.com)