

Wide input voltage, Non-isolated and regulated single output

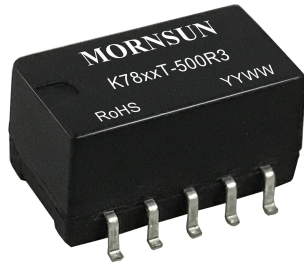

Report EN 62368-1
 Report BS EN 62368-1
 RoHS

FEATURES

- High efficiency up to 95%
- No-load input current as low as 0.2mA
- Operating ambient temperature range: -40°C to +85°C
- Output short-circuit protection
- SMD package

K78_T-500R3 series are high efficiency switching regulators. The converters feature high efficiency, low loss and short circuit protection in a compact SMD package. These products are widely used in applications such as industrial control, instrumentation and electric power.

Selection Guide

Certification	Part No.	Input Voltage (VDC)*	Output		Full Load Efficiency (%) Typ. Vin Min. / Vin Max.	Capacitive Load (µF) Max.
		Nominal (Range)	Voltage (VDC)	Current (mA) Max.		
EN/BS EN	K7801T-500R3	12 (4.75-28)	1.5	500	76/67	680
	K78X2T-500R3	12 (4.75-28)	1.8	500	76/69	680
	K7802T-500R3	12 (4.75-32)	2.5	500	81/74	680
	K7803T-500R3	24 (4.75-36)	3.3	500	86/80	680
	K7805T-500R3	24 (6.5-36)	5	500	90/84	680
	K78X6T-500R3	24 (8-36)	6.5	500	92/87	680
	K7809T-500R3	24 (12-36)	9	500	93/90	680
	K7812T-500R3	24 (15-36)	12	500	94/91	680
	K7815T-500R3	24 (19-36)	15	500	95/93	680

Note*: For input voltage exceeding 30 VDC, an input capacitor of 22µF/50V is required.

Input Specifications

Item	Operating Conditions	Min.	Typ.	Max.	Unit
No-load Input Current		--	0.2	1.5	mA
Reverse Polarity at Input		Avoid / Not protected			
Input Filter		Capacitance filter			
Ctrl*	Module on	Ctrl pin open or pulled high (TTL 3.2-8VDC)			
	Module off	Ctrl pin pulled low to GND (0-0.8VDC)			
	Input current when off	--	30	100	µA

Note: *The Ctrl pin voltage is referenced to input GND.

Output Specifications

Item	Operating Conditions	Min.	Typ.	Max.	Unit	
Voltage Accuracy	Full load, input voltage range	1.5/1.8/2.5/3.3 VDC output	--	±2	±4	%
		Other output	--	±2	±3	
Linear Regulation	Full load, input voltage range	--	±0.2	±0.4		

Load Regulation	Nominal input voltage, 10% -100% load	1.5/1.8/2.5/3.3/5 VDC output	--	±0.6	--	%
		Other output	--	±0.3	--	
Ripple & Noise*	20MHz bandwidth, nominal input voltage	1.5/1.8/2.5/3.3 VDC output, 20% -100% load	--	20	50	mVp-p
		Other output, 10% -100% load	--	20	50	
Temperature Coefficient	Operating temperature -40°C to +85°C		--	--	±0.03	%/°C
Transient Response Deviation	Nominal input voltage, 25% load step change		--	50	200	mV
Transient Recovery Time			--	0.2	1	ms
Short-circuit Protection	Nominal input voltage		Continuous, self-recovery			
Vadj	input voltage range		-10	--	+10	%Vo

Note: *

- The "parallel cable" method is used for Ripple and Noise test, please refer to DC-DC Converter Application Notes for specific information;
- With light loads at or below 20%, Ripple & Noise for 1.5/1.8/2.5/3.3V output parts increases to 100mVp-p max. and a load below 10% for 5V/6.5V/9V/12V/15V output parts levels increase to 150mVp-p max.

General Specifications

Item	Operating Conditions	Min.	Typ.	Max.	Unit	
Operating Temperature	See Fig. 1	-40	--	+85	°C	
Storage Temperature		-55	--	+125		
Storage Humidity	Non-condensing	5	--	95	%RH	
Reflow Soldering Temperature	Peak temperature ≤245°C, duration ≤60s max. over 217°C. Also refer to IPC/JEDEC J-STD-020D.1.					
Switching Frequency	Full load, nominal input	K7801T-500R3	--	370	--	kHz
		Other output	--	700	--	
MTBF	MIL-HDBK-217F@25°C	2000	--	--	k hours	
Moisture Sensitivity Level (MSL)*	IPC/JEDEC J-STD-020D.1	Level 1				

Note: * For actual application, please refer to IPC/JEDEC J-STD-020D.1.

Mechanical Specifications

Case Material	Black plastic; flame-retardant and heat-resistant (UL94V-0)
Dimensions	15.24 x 11.40 x 8.25mm
Weight	1.5g (Typ.)
Cooling Method	Free air convection

Electromagnetic Compatibility (EMC)

Emissions	CE	CISPR32/EN55032	CLASS B (see Fig. 4-② for recommended circuit)		
	RE	CISPR32/EN55032	CLASS B (see Fig. 4-② for recommended circuit)		
Immunity	ESD	IEC/EN 61000-4-2	Contact ±4kV		perf. Criteria B
	RS	IEC/EN 61000-4-3	10V/m		perf. Criteria A
	EFT	IEC/EN 61000-4-4	±1kV (see Fig. 4-① for recommended circuit)		perf. Criteria B
	Surge	IEC/EN 61000-4-5	line to line ±1kV (see Fig. 4-① for recommended circuit)		perf. Criteria B
	CS	IEC/EN 61000-4-6	3Vr.m.s		perf. Criteria A

Typical Characteristic Curves

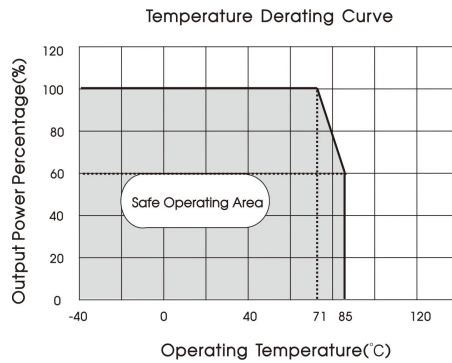
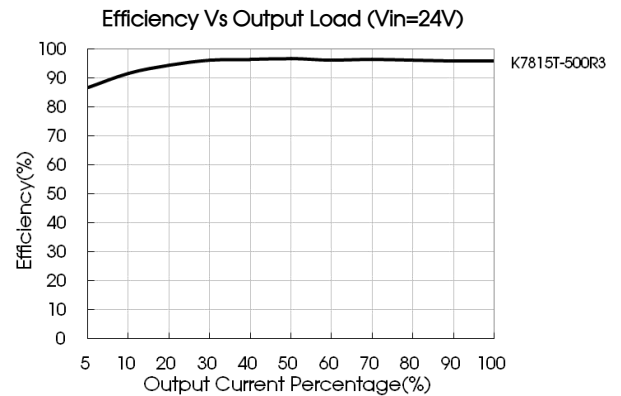
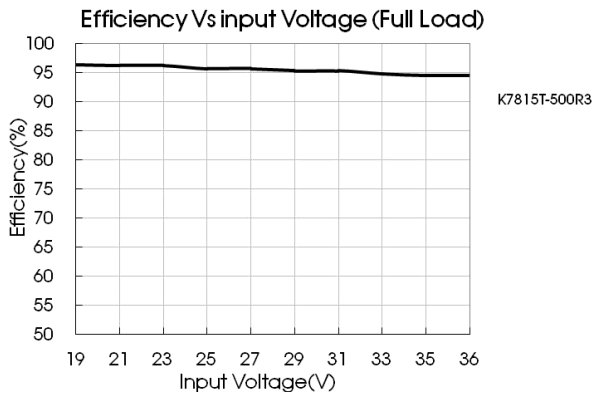
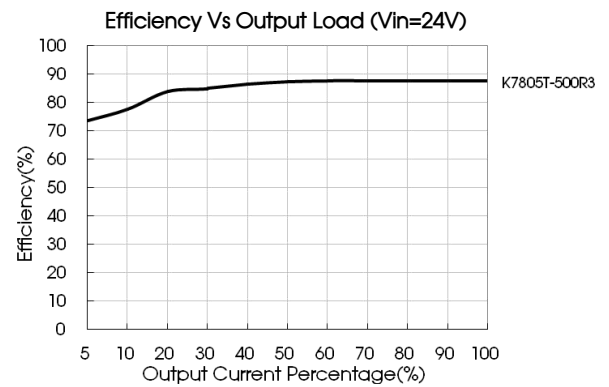
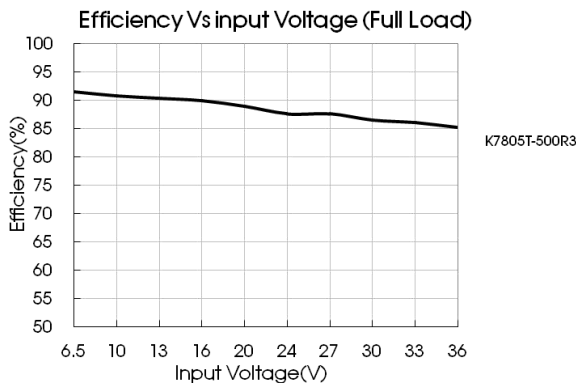

Fig. 1



Design Reference

1. Typical application

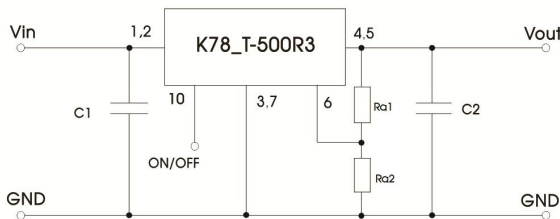

Fig. 2 Typical application circuit

Part No.	C1 (ceramic capacitor)	C2 (ceramic capacitor)	Ra1/Ra2 (Vadj resistance)
K7801T-500R3	10µF/50V	22µF/10V	Refer to Vadj resistance calculation
K78X2T-500R3		22µF/10V	
K7802T-500R3		22µF/10V	
K7803T-500R3		22µF/10V	
K7805T-500R3		22µF/16V	
K78X6T-500R3		22µF/16V	
K7809T-500R3		22µF/25V	
K7812T-500R3		22µF/25V	
K7815T-500R3		22µF/25V	

table 1

- Note:
1. The required C1 and C2 capacitors must be connected as close as possible to the terminals of the module;
 2. Refer to Table 1 for C1 and C2 capacitor values. For certain applications, increased values and/or tantalum or low ESR electrolytic capacitors may also be used instead;
 3. Converter cannot be used for hot swap and with output in parallel;
 4. To further reduce the output ripple and noise, we suggested the use of a "LC" filter at the output terminals, with an inductor value (L) of 10μH-47μH.

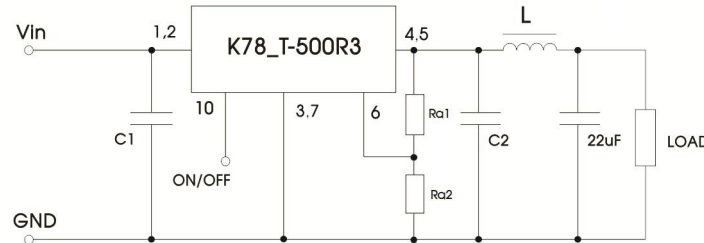

Fig. 3 External "LC" output filter circuit diagram

2. EMC Compliance circuit

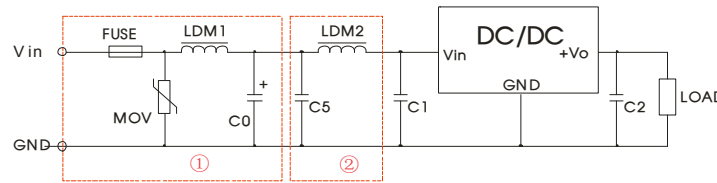

Fig.4 Recommended compliance circuit

FUSE	MOV	LDM1	C0	C1/C2	C5	LDM2
Select fuse value according to actual input current	S20K30	82μH	680μF /50V	Refer to table 1	4.7μF /50V	12μH

Note: Part ① in Fig. 4 shows Immunity compliance filter and part ② filter for Emission compliance; depending on requirement both filters ① and ② can be used in series as shown.

3. Trim Function for Output Voltage Adjustment (open if unused)

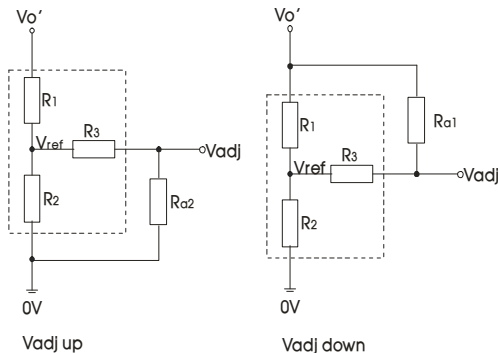

Fig. 5 Circuit diagram of Vadj up and down (dashed line shows internal part of module)

Calculating Trim resistor values:

$$\begin{aligned} \text{up: } Ra2 &= \frac{\alpha R2}{R2 - \alpha} - R3 & \alpha &= \frac{Vref}{Vo' - Vref} \cdot R1 \\ \text{down: } Ra1 &= \frac{\alpha R1}{R1 - \alpha} - R3 & \alpha &= \frac{Vo' - Vref}{Vref} \cdot R2 \end{aligned}$$

Ra1, Ra2= Trim Resistor value;
Vo' = desired output voltage.
α = self-defined parameter;

Vout(V)	R1(kΩ)	R2(kΩ)	R3(kΩ)	Vref(V)
1.5	7.5	7.5	15	0.75
1.8	35.7	26.29	100	0.765
2.5	27	11.858	51	0.765
3.3	33	9.9	47	0.765
5	75	13.5	75	0.765
6.5	75	10	51	0.765
9	51	4.7	27	0.765
12	75	5.1	27	0.765
15	82	4.423	27	0.765

Note: The 1.5V model's output voltage can only be adjusted up (Vadj up) and cannot be adjusted to a lower voltage (Vadj down is not applicable).

4. For additional information please refer to DC-DC converter application notes on

www.mornsun-power.com

Dimensions and Recommended Layout

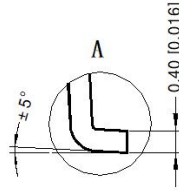
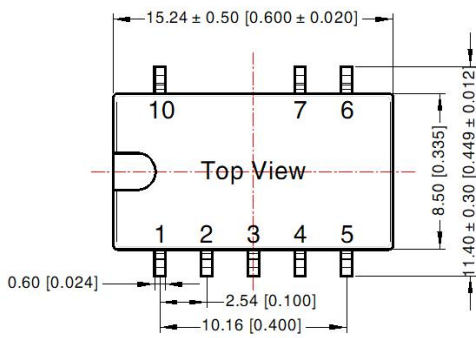

THIRD ANGLE PROJECTION

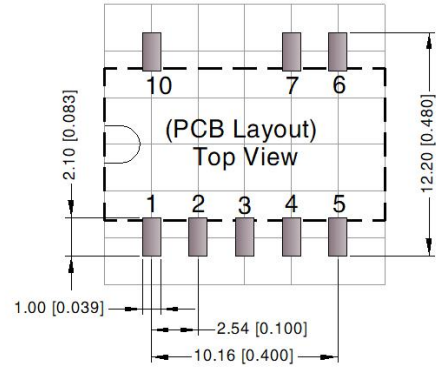

Note: Grid 2.54*2.54mm

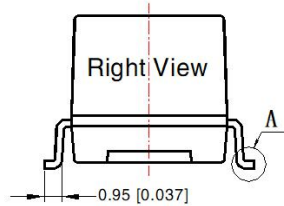
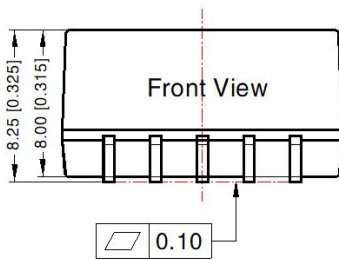

Pin-Out	
Pin	Mark
1	+Vin
2	+Vin
3	GND
4	+Vout
5	+Vout
6	V adj
7	GND
10	Remote On/Off

Note:
Unit: mm[inch]
Pin section tolerances: $\pm 0.10[\pm 0.004]$
General tolerances: $\pm 0.25[\pm 0.010]$

NC: Pin to be isolated from circuitry

Notes:

- For additional information on Product Packaging please refer to www.mornsun-power.com. Tape Packaging bag number: 58210057, Reel packaging bag number:58210058.
- The specified maximum capacitive load is tested under full load condition and over the input voltage range;
- All parameters in this datasheet were measured under following conditions: $T_a=25^{\circ}\text{C}$, relative humidity <75%RH, nominal input voltage and rated output load (unless otherwise specified);
- All index testing methods in this datatable are based on our company corporate standards;
- The performance indexes of the product models listed in this manual are as above, but some indexes of non-standard model products will exceed the above-mentioned requirements, and please directly contact with our technician for specific information;
- Products are related to laws and regulations: see "Features" and "EMC";
- Our products shall be classified according to ISO14001 and related environmental laws and regulations, and shall be handled by qualified units.

Mornsun Guangzhou Science & Technology Co., Ltd.

Address: No. 5, Kehui St. 1, Kehui development center, Science Ave., Guangzhou Science City, Huangpu district, Guangzhou, P.R. China

Tel: 86-20-38601850

Fax: 86-20-38601272

E-mail: info@mornsun.cn

www.mornsun-power.com