



Monolithic ICs

T-77-01



T-58-01

T-50-15

.. Under Development

● Communication Systems

Type	Function	Package		Features	Reference Catalog
		Configuration	No. of pins		
BA631	FM intercom	DIP	14	PLL circuit allows easy adjustment. Usable either as a transmitter or as a receiver by changing the external components.	No.2708
BA1602L	FM intercom	LF	18	PLL synthesizer; full duplex communication possible.	No.3121
BA4112	Narrow-band FM-IF system for communication equipment	DIP	16	IF amp. for FM communication equipment + detector with squelch.	No.3121
BA4113	Narrow-band FM-IF system for communication equipment	DIP	18	IF amp. for FM communication equipment + detector with squelch and center meter driver output.	No.3121
BA4114	Narrow-band FM-IF system for communication equipment	DIP	16	Low voltage operation $V_{cc}=1.8\sim 7.0V$; few external components.	No.3121
BA3814L	Power controller	LF	16	Power ON/OFF controller with 2 internal comparators.	—
BA3414L	Microphone amp. for communication equipment	LF	16	Internal send/receive switch and preamp. with limiter.	No.3121

● Special Applications

BA6527A	Leak breaker	SIP	8	Capable of detecting minute signal.	No.2708
BA7042	VCO with adjustable sensitivity	DIP	8	Center frequency can be set by external constant. Frequency control sensitivity can be set by external constant (built-in amplifier for sensitivity control);	—
BU2112F	Battery charger controller for Ni-Cd battery	DIP	18	Built-in protection using 8-bit PWM	—
BU2911	Door chime	DIP	18	Contains six different chime sounds including two unisons; 3V power supply; level and one-shot selectable.	No.3121
 ☆ BA6592F	Color TV signal generator RGB TO NTSC/PAL ENCODER	MF	24	Contains and NTSC or PAL color TV signal generator. Equipped with separate Y/C outputs.	—



Dimensions (Unless otherwise specified, dimensions are shown in Typ. values.)

SIP

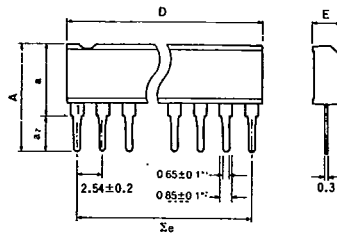

• SIP Dimensions (Unit: mm)

Package	A	a	a ₂	D	Σe	E
SIP 5	9.7	6.2	3.5	12.0	10.16	2.4
SIP 7	9.7	6.2	3.5	17.0	15.24	2.8
SIP 8	10.5	7.0	3.5	19.5	17.78	2.8
SIP 9	10.5	7.0	3.5	22.0	20.32	2.8
SIP 10	10.5	7.0	3.5	25.2	22.86	2.8

*1 SIP 10pin: 0.6 *2 SIP 10pin: 0.8

DIP/DIPS

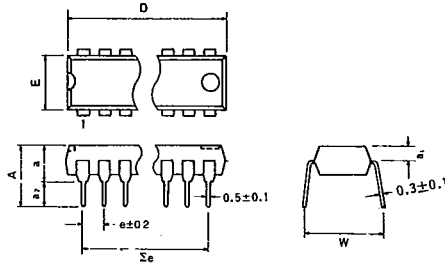

• DIP Dimensions (Unit: mm)

Package	A	a	a ₁	a ₂	D	e	Σe	E	W
DIP 8	6.8	3.6	1.1	3.2	9.3	2.54	7.62	6.5	8.8
DIP 14	6.94	3.65	1.65	3.29	19.4	2.54	15.24	6.5	8.8
DIP 16	6.94	3.65	1.65	3.29	19.4	2.54	17.78	6.5	8.8
DIP 18	6.94	3.65	1.65	3.29	22.9	2.54	20.32	6.5	8.8
DIP 20	7.09	3.65	1.65	3.44	26.3	2.54	22.86	6.5	8.8
DIP 22	7.09	3.65	1.65	3.44	26.3	2.54	25.40	6.5	8.8
DIP 24	7.51	4.22	1.8	3.29	32.0	2.54	27.94	13.8	16.5
DIP 28	7.51	4.22	1.8	3.29	37.1	2.54	33.02	13.8	16.5
DIP 40	7.7	4.5	1.8	3.2	52.3	2.54	48.26	13.8	16.5
DIPS 18	7.35	3.65	1.65	3.7	19.4	1.778	14.224	6.5	8.8
DIPS 22	7.35	3.65	1.65	3.7	19.4	1.778	17.78	6.5	8.8
DIPS 24	7.4	4.0	1.7	3.4	22.8	1.778	19.558	6.5	8.8
DIPS 30	7.9	4.7	1.7	3.2	28.0	1.778	24.892	8.4	11.4
DIPS 32	7.9	4.7	1.7	3.2	28.0	1.778	26.67	8.4	11.4
DIPS 42	7.7	4.5	1.8	3.2	37.1	1.778	35.56	13.8	16.5

MF/MFS/MFP

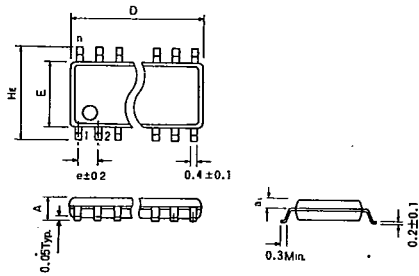

• MF Dimensions (Unit: mm)

Package	A	a ₁	D	H _e	e	E
MF 8	1.5	0.65	5.0	6.2	1.27	4.4
MF 14	1.5	0.65	8.7	6.2	1.27	4.4
MF 16	1.5	0.65	10.0	6.2	1.27	4.4
MF 18	1.8	0.8	11.2	7.8	1.27	5.4
MF 20	1.8	0.8	12.5	7.8	1.27	5.4
MF 22	1.8	0.8	13.7	7.8	1.27	5.4
MF 24	1.8	0.8	15.0	7.8	1.27	5.4
MF 28	2.2	1.0	18.5	9.9	1.27	7.5
MFS 16	1.5	0.65	6.6	6.2	0.8	4.4
MFS 20	1.8	0.8	8.7	7.8	0.8	5.4
MFS 24	1.8	0.8	10.0	7.8	0.8	5.4
MFP 24	1.9	0.8	13.7	7.8	0.8	5.4
MFP 28	2.2	0.95	18.5	9.9	0.8	7.5

LF/LFS

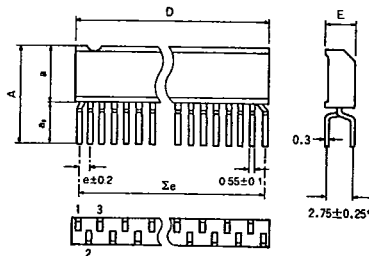

• LF Dimensions (Unit: mm)

Package	A	a	a ₂	D	Σe	e	E
LF 9	9.8	5.0	4.8	12.0	10.16	1.27	2.4
LF 12	9.8	5.0	4.8	17.0	13.97	1.27	2.8
LF 16	9.9	5.8	4.1	19.5	19.05	1.27	2.8
LF 18	9.9	5.8	4.1	22.0	21.59	1.27	2.8
LFS 24	10.0	5.8	4.2	22.0	20.447	0.889	2.8

*LFS 24: 2.54±0.25



Monolithic ICs



T-90-20

QFP/QFPS

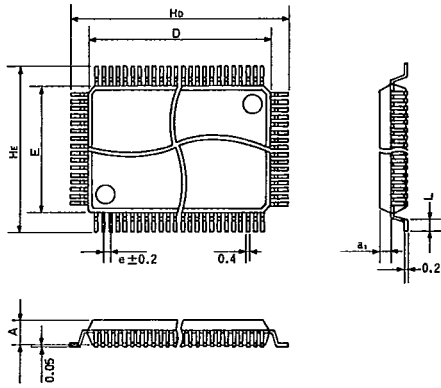

• QFP Dimensions (Unit: mm)

Package	A	a_1	D	e	E	H_E	H_D	L
QFP 32	1.45	0.65	7.0	0.8	7.0	9.0	9.0	0.4
QFP 44	2.15	1.0	10.0	0.8	10.0	14.0	14.0	1.2
QFP 64	2.15	1.0	20.0	1.0	14.0	18.0	24.0	1.2
QFP 80	2.7	1.275	20.0	0.8	14.0	18.0	24.0	1.2
QFPS 56	2.15	1.0	10.0	0.65	10.0	12.4	12.4	0.5
QFPS 80	2.7	1.275	14.0	0.65	14.0	16.4	16.4	0.5
QFPS 100	2.7	1.275	20.0	0.65	14.0	18.0	24.0	1.2

SIP-P 10 pin

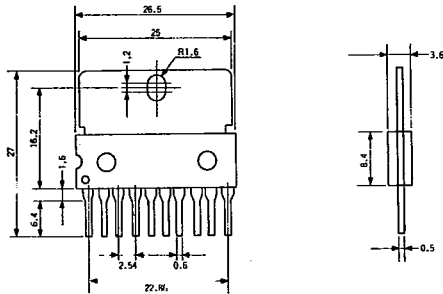

SIP-P 12 pin

