





<b>APPROVAL</b>		
<b>Electrical</b>	<b>UL</b>	<b>IEC</b>
Standard	600V	1000V
Rated voltage	52A	41A
Rated current	20AWG	0.5mm <sup>2</sup>
Wire range	AC3500V/1Min	
Withstanding voltage		
<b>Mechanical</b>		
Ambient temperature	-40°C~+105 °C	
Strip length	12mm	
Torque	1.2Nm(10.5Lb-In)	
<b>Dimensions</b>		
Pitch	10.16mm(.400" )	
Poles	2P-9P	
<b>Material</b>		
Housing	PA66,UL94V-0	
Contact	Copper	
Screws	M4,Steel, Cr <sup>3+</sup> Zn-plated	
Cage	Brass,Ni-plated	



### HOW TO ORDER :

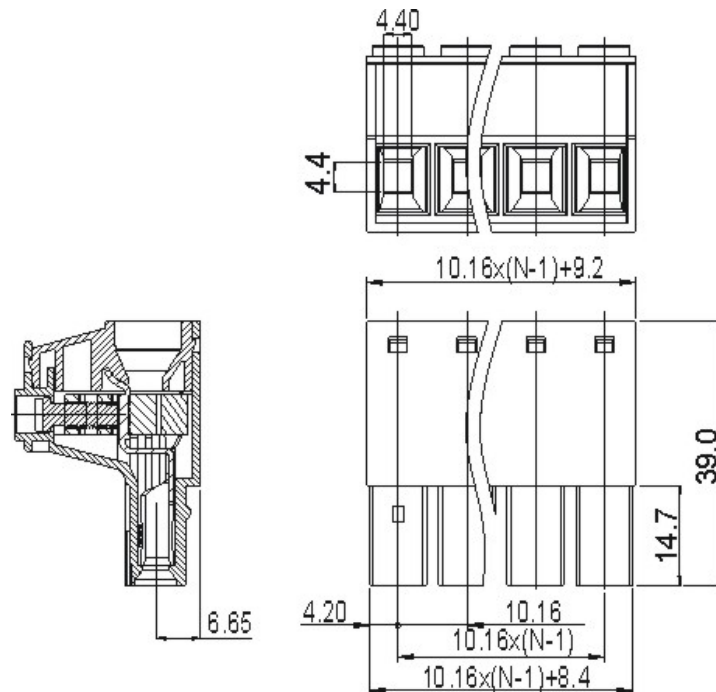
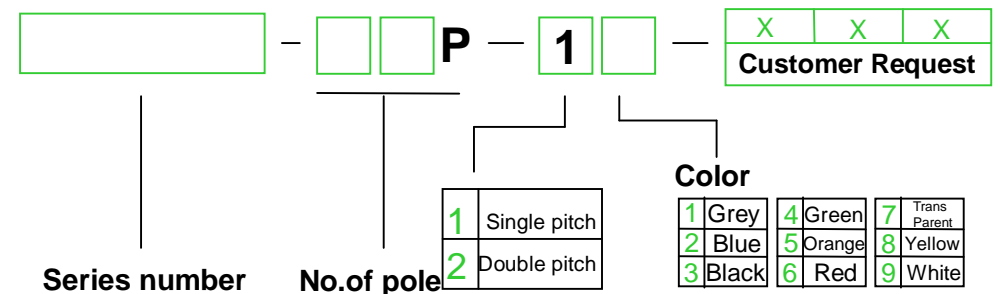
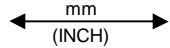

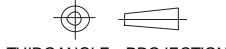
 mm (INCH)	 <b>DEGSON ELECTRONICS CO., LTD.</b>
 THROANGLE PROJECTION	<b>NAME</b> <b>5EDGK-10.16</b>