

4 WAY D/DOOR

FREE STANDING KIOSK

- Kiosk Removable from Base & Frame
- Hot Dipped Galvanised or Stainless Steel Frame and Gland plate
- Unistrut Available in place of Gland Plate
- Stainless Steel Butt Hinges
- Lever Lock Handle or Stainless Steel Thru Lock
- Vents in Roof Overhang
- Nylon Door Restraints
- Can be Supplied Fully Wired & Fitted
- Phase, Neutral & Earth Bars Supplied as Optional Extras
Busbars Mounted on Colour Coded Insulators

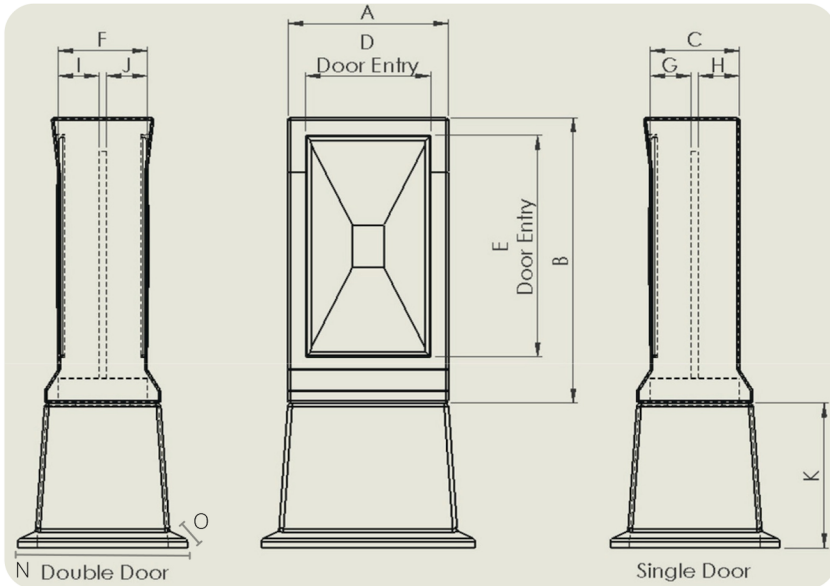
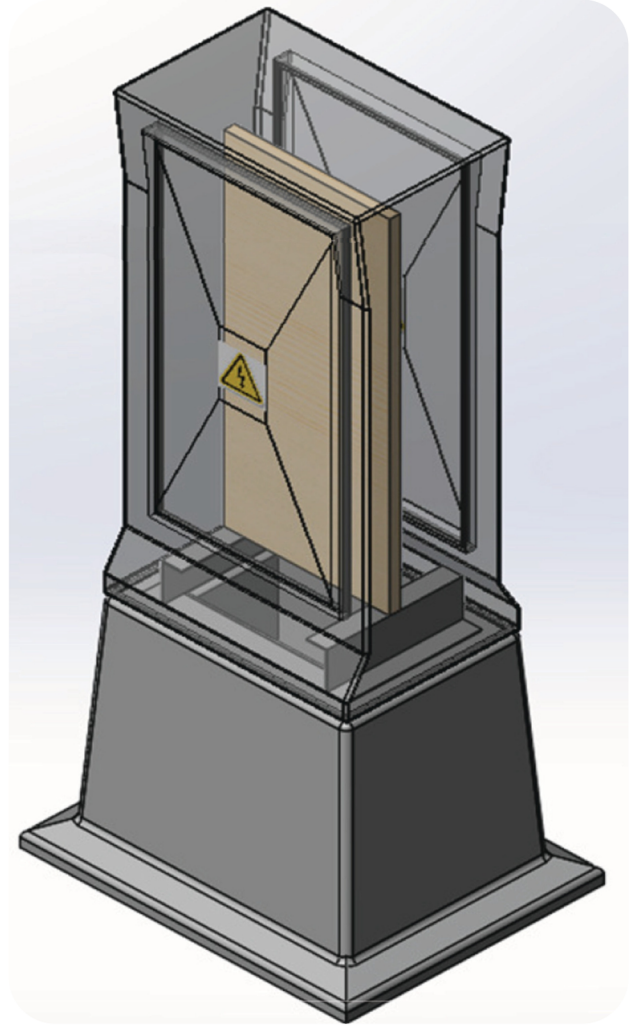

TYPE	DIMENSIONS (mm)															SPACE ON BOARD				
	A	B	C	D	E	F	G	H	I	J	K	L	M	N	O	FRONT		BACK		
																	H	W	H	W
4 WAY D/DOOR	570	670		365	375	435			145	155	370				680	590	450	445	450	395

**Kiosks available in Grey or Light Stone as Standard
Other Colours are available on request**

