

\*RoHS COMPLIANT

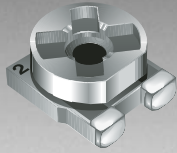

**BOURNS®**

**Features**

- Recommended for reflow processing
- Rotor design compatible with pick and place and automatic adjustment equipment
- Supplied in 8 mm embossed tape, compatible with automatic assembly equipment
- Rear adjust version available
- 3 mm size meets EIA/EIAJ standard trimmer footprint
- RoHS compliant\* - see processing information on lead free surface mount trimmers

**3303 - 3 mm SMD Trimming Potentiometer**

**Electrical Characteristics**

Standard Resistance Range .....100 ohms to 1 megohm  
 (see standard resistance table)  
 Resistance Tolerance .....±25 % std.  
 Absolute Minimum Resistance  
 ≤ 1K Ohms .....20 ohms max.  
 >1K Ohms .....2 % max. of TR  
 Contact Resistance Variation ..5 % max.  
 Resolution .....Infinite  
 Adjustment Angle .....260 ° ±20 °

**Environmental Characteristics**

Resistance to Soldering Heat  
 .....260 °C, 10 seconds, TRS max. 5 %  
 Power Rating (50 VDC max.)  
 70 °C .....0.15 watt  
 Temperature Range  
 .....-40 °C to +125 °C  
 Temperature Coefficient  
 .....±250 ppm/°C  
 Humidity .....95 %RH  
 500 hours  
 TRS max. ....±5 %  
 Load Life  
 .....@ 70 °C rated power 500 hours  
 TRS ± 5 %  
 Rotational Cycling .....20 turns  
 TRS ±15 %

**Physical Characteristics**

Torque .....20-200 g-cm max.  
 Mechanical Angle .....Continuous  
 Marking .....Part marking code  
 Standard Packaging  
 .....2000 pcs./7 " reel  
 Adjustment Tool .....H-90

**How To Order**

**3303 X - 3 - 103 E**

Model \_\_\_\_\_  
 Style \_\_\_\_\_  
 Orientation of Parts In Tape:  
 • Styles W, C - Terminals Toward Sprocket Holes  
 • Styles X, D - Terminals Away From Sprocket Holes (preferred)  
 Standard or Modified Product Indicator \_\_\_\_\_  
 -1 = Single Slot (C, D Pin Styles Only)  
 -3 = Cross Slot Low Profile (W, X Pin Styles Only)  
 Resistance Code \_\_\_\_\_  
 Embossed Tape Designator \_\_\_\_\_  
 Consult factory for other available options.

**3303W, X-3**  
**3mm Open Frame**  
**for Reflow Soldering**  
**3-Terminal**  
**Low Profile**

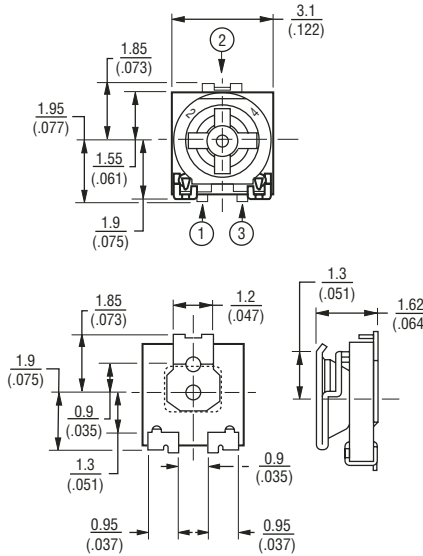

**SUGGESTED PWB LAYOUT**

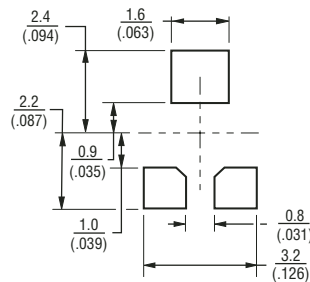

TOLERANCES: ± 0.30 (.012) EXCEPT WHERE NOTED

DIMENSIONS ARE:  $\frac{\text{MM}}{\text{(INCHES)}}$

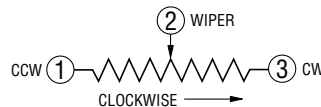

**3303C,D-1**  
**3-Terminal**  
**Both Sides Adjust**  
**(OPTIONAL)**

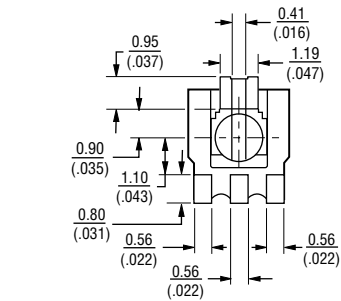
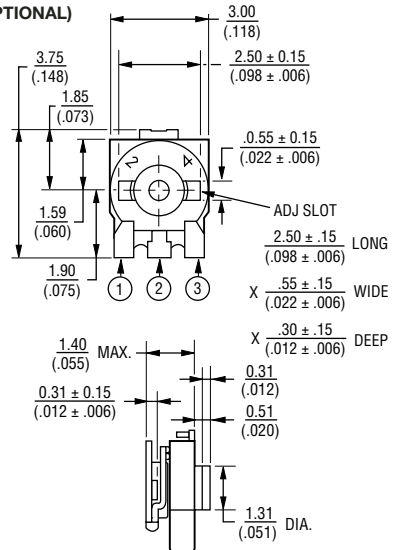

**SUGGESTED PWB LAYOUT**

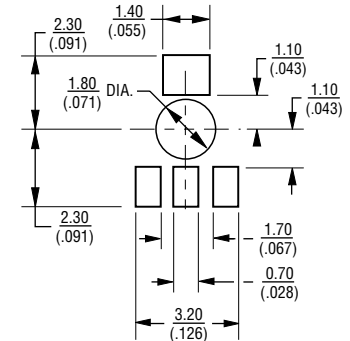

TOLERANCES: ± 0.38 (.015) EXCEPT WHERE NOTED

DIMENSIONS ARE:  $\frac{\text{MM}}{\text{(INCHES)}}$

\*RoHS Directive 2002/95/EC Jan 27 2003 including Annex. Specifications are subject to change without notice. Customers should verify actual device performance in their specific applications.

# 3303 - 3 mm SMD Trimming Potentiometer



## Packaging Specifications

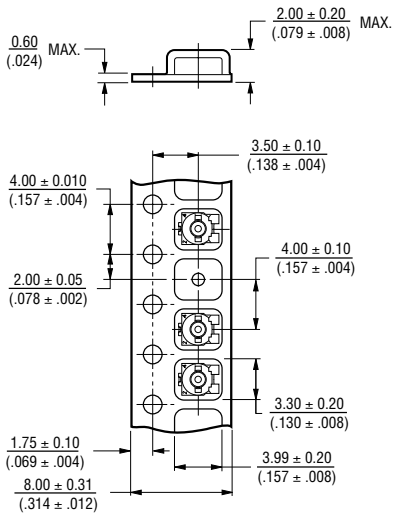

TAPE

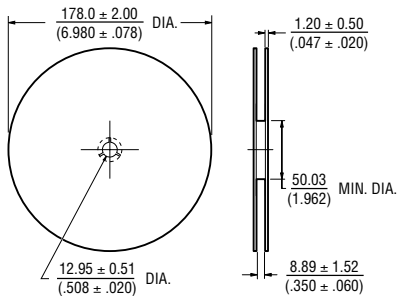

REEL

Meets EIA 481

TOLERANCES: ± 0.25 (.010) EXCEPT WHERE NOTED

DIMENSIONS ARE:  $\frac{\text{MM}}{\text{(INCHES)}}$

## Standard Resistance Table

Resistance (Ohms)	Part Marking Code	Resistance Code
100	12	101
200	22	201
500	52	501
<b>1,000</b>	<b>13</b>	<b>102</b>
<b>2,000</b>	<b>23</b>	<b>202</b>
<b>5,000</b>	<b>53</b>	<b>502</b>
<b>10,000</b>	<b>14</b>	<b>103</b>
<b>20,000</b>	<b>24</b>	<b>203</b>
50,000	54	503
100,000	15	104
200,000	25	204
500,000	55	504
1,000,000	16	105

Popular distribution resistance values listed in boldface. Special resistances available.