

Product Catalogue 2019

Lightings



Camelion®
More Energy Solutions

www.camelionbattery.com



More Energy Solutions

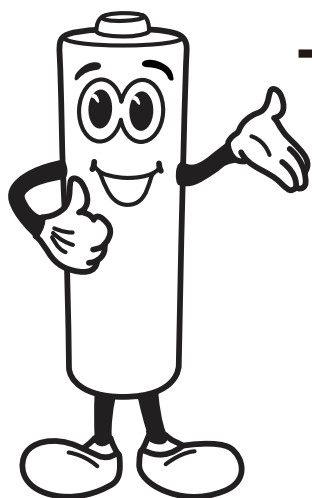

**Try us out
today!**

- Flashlight
- Rechargeable Flashlight
- Spotlight
- Lantern
- Rechargeable Lantern
- Work Light
- Rechargeable Work Light
- Safety Light
- Home Lighting
- Professional Lighting

CONTENT

Flashlight

Aluminum Flashlight

T13, T511, T558, T536, T556 **4**

LED Pocket Flashlight

HP7011 **6**

LED Rubber Flashlight

PT1L2D, PT1L2AA **6**

LED Flashlight

FL1L2D, FL1L2C, FL1L2AA **8**

Rechargeable Flashlight

Rechargeable Aluminum Flashlight

RT396, RT397, RT398 **10**

Rechargeable LED Flashlight

RHP6041, RHP6062 **12**

Spotlight

S32, FL-16LED, FL-9LED, CM25L **14**

Lantern

LED Lantern

SL2011, SL1011N **16**

Rechargeable Lantern

Rechargeable Lantern

RS650, RS651 **18**

Work Light

Work Light

S31, SL5240N, SL7280N **20**

Switch Light

S35, S28, T11 **22**

Rechargeable Work Light

Work Light

S20, RS60 **24**

S21, S22 **26**

Safety Light

Safety Light

S48, S652, S53, S767, T556S **28**

S760, S766, S765, S769, S711 **30**

Home Lighting

Sensor Light

S50, L7018, SL7019, **32**

Tap Light

SL7015 **32**

Professional Lighting

Head Light

S51, S58 **34**

Pen Light

DL2AAAS **34**

LED Pen Light

DL2AAASL **34**

Flashlight

Maximum Illumination in a Professional, Durable Design



Aluminum Flashlight

- Broad & effective lighting range
- Unbreakable anodized aircraft aluminum alloy
- Ultra bright LED light source
- Shock resistant and weatherproof
- Professional lighting for security purposes or outdoor activities

Specifications							
Model#	LEDs	LED Type	Luminous Flux	Battery Mode	Body Material	Available Colors	Water Resistant (Y/N)
T13	1	CREE® XT-E 5W + COB 3W LED	400Lm	3 x AA	Aircraft aluminum	■ Black	Y
T511	1	CREE® XR-E 3W LED	150Lm	3 x D	Aircraft aluminum	■ Black	Y
T558	1	CREE® XR-E 3W LED	150Lm	2 x AA	Aircraft aluminum	■ Black	Y
T536	1	CREE® XR-E 3W LED	120Lm	3 x AAA	Aircraft aluminum	■ Black	Y
T556	1	CREE® XP-E 3W LED	120Lm	3 x AAA	Aircraft aluminum	■ Black	Y

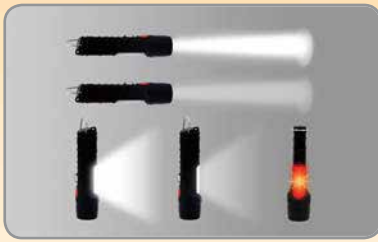

T13



CREE® XT-E
5W LED



Exceptional Illumination



Aircraft Aluminium Alloy

T511



CREE® XR-E
3W LED



T511-DB

T558



CREE® XR-E
3W LED



T558-DB

3 Lighting Modes

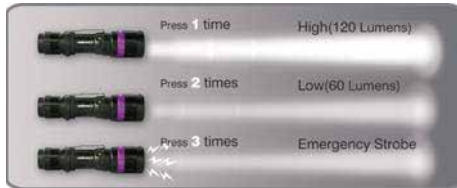

T536



CREE® XR-E
3W LED



T536-3LR03BP

Directions

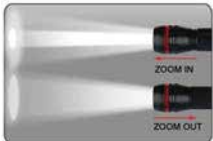

3 Lighting modes with red alarm ring

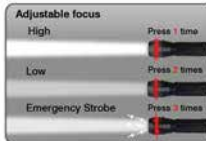

T556



CREE® XP-E
3W LED



T556-3LR03 BP

Packaging Details

Item#	Packaging Type	Batteries Included	Blister/Details					Outer Carton Details					
			Dimensions (mm)			Net Weight (g)	Packs/ Carton	Dimensions (cm)			Volume (M ³)	Gross Weight (Kg)	Net Weight (kg)
			L Length	W Width	D Depth			L Length	W Width	H Height			
T511-DB	Double Blister	—	393	141	60	310	12	29.2	22.5	41.8	0.0275	4.3	3.7
T558-DB	Double Blister	—	113	280	39	93	24	33.0	17.8	31.7	0.0187	3.0	2.2
T558-2LR6DB	Double Blister	2LR6	113	280	39	141	24	33.0	17.8	31.7	0.0187	4.2	3.4
T536-3LR03BP	Blister Pack	3LR03	250	150	38	214	24	47.5	31.0	27.5	0.0405	6.2	5.1
T556-3LR03BP	Blister Pack	3LR03	110	190	38	144	24	49.5	27.5	25	0.0340	7.8	7.0

Flashlight

Ideal Lighting for Outdoors



LED Pocket Flashlight

- Ultra shock resistant up to 3 meters drop height
- Continuous lighting up to 20 hrs
- LED light source
- Water resistant (IPX4)*
- Slim portable design



LED Rubber Flashlight

- Shock resistant up to 2 meter drop height
- LED light source providing outstanding illumination
- Water proof of IPX7 standard**
- Long continuous operating time
- Lanyard included

*IPX4 water resistant: Water splashed against the product from any direction shall have no harmful effect.

**IPX7 water proof: Ingress of water in quantities causing harmful effects shall not be possible when the enclosure is temporarily immersed in water under standardized conditions of pressure and time

Model#	Specifications						
	LEDs	LED Type	Luminous Flux	Battery Mode	Body Material	Available Colors	Water Resistant (Y/N)
HP7011	1	1W LED	90Lm	3 x AAA	Rubber	<div style="display: inline-block; width: 10px; height: 10px; background-color: red; margin-right: 5px;"></div> Red <div style="display: inline-block; width: 10px; height: 10px; background-color: green; margin-right: 5px;"></div> Green	Y
PT1L2D	1	0.5W LED	45Lm	2 x D	Rubber	<div style="display: inline-block; width: 10px; height: 10px; background-color: red; margin-right: 5px;"></div> Red <div style="display: inline-block; width: 10px; height: 10px; background-color: blue; margin-right: 5px;"></div> Blue	Y
PT1L2AA	1	0.5W LED	45Lm	2 x AA	Rubber	<div style="display: inline-block; width: 10px; height: 10px; background-color: red; margin-right: 5px;"></div> Red <div style="display: inline-block; width: 10px; height: 10px; background-color: blue; margin-right: 5px;"></div> Blue	Y

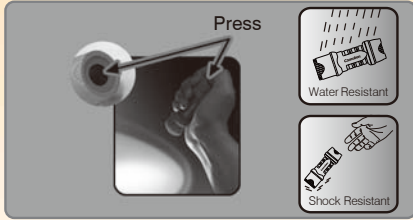

HP7011



HP7011-BP



HP7011-3R03BP



HP7011D24
HP7011-3R03PD24

PT1L2D



PT1L2D-2R20PBP



PT1L2DBP

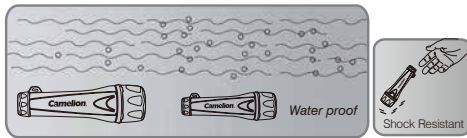

PT1L2AA



PT1L2AA-2R6PBP



PT1L2AABP

Packaging Details

Item#	Packaging Type	Batteries Included	Blister/Display Details					Outer Carton Details					
			Dimensions (mm)			Net Weight (g)	Packs/ Carton	Dimensions (cm)			Volume (M ³)	Gross Weight (Kg)	Net Weight (kg)
			L Length	W Width	D Depth			L Length	W Width	H Height			
HP7011-3R03BP	Blister Pack	3R03P	190	110	40	96.5	48	51.5	21.5	26.5	0.0294	6.4	4.7
HP7011-BP	Blister Pack	—	190	110	40	74	48	46.5	41.5	21.5	0.0415	4.8	3.7
HP7011-3R03PD24	Display Box	3R03P	303	206	110	2036	4	46	34	25	0.0391	9.3	8.2
HP7011D24	Display Box	—	303	206	110	1496	4	46	34	25	0.0391	7.1	6.0
PT1L2D-2R20PBP	Blister Pack	2R20P	305	175	70	446	24	50.5	45	33	0.0750	11.7	10.7
PT1L2DBP	Blister Pack	—	305	175	70	279	24	50.5	45	33	0.0750	7.7	6.7
PT1L2AA-2R6PBP	Blister Pack	2R6P	248	120	50	161	48	49.5	36	33	0.0588	8.7	7.7
PT1L2AABP	Blister Pack	—	248	120	50	131	48	49.5	36	33	0.0588	7.3	6.3

Flashlight

LED Flashlights for Home and Outdoors



LED Flashlight

- Maximum focus and light intensity
- Long continuous operating hours
- Non replace needed LED light source
- Anti-roll design, handy grip and a hook ring

Model#	Specifications						
	LEDs	LED Type	Luminous Flux	Battery Mode	Body Material	Available Colors	Water Resistant (Y/N)
FL1L2D	1	0.5W LED	45Lm	2 x D	Plastic	<div style="display: flex; flex-direction: column; gap: 2px;"> ■ Red ■ Yellow ■ Blue ■ Black </div>	N
FL1L2C	1	0.5W LED	45Lm	2 x C	Plastic	<div style="display: flex; flex-direction: column; gap: 2px;"> ■ Red ■ Yellow ■ Blue ■ Black </div>	N
FL1L2AA	1	0.5 W LED	35Lm	2 x AA	Plastic	<div style="display: flex; flex-direction: column; gap: 2px;"> ■ Red ■ Yellow ■ Blue ■ Black </div>	N



Hook Ring

 **1LED**

FL1L2D

Up to **200 Hrs**
Continuous use



FL1L2DR20P



FL1L2DD12

 **1LED**

FL1L2C

Up to **90 Hrs**
Continuous use



FL1L2C2R14P

 **1LED**

FL1L2AA

Up to **35 Hrs**
Continuous use



FL1L2AAR6P



FL1L2AAD24

Packaging Details

Item#	Packaging Type	Batteries Included	Blister/Display Details					Outer Carton Details					
			Dimensions (mm)			Net Weight (g)	Packs/ Carton	Dimensions (cm)			Volume (M ³)	Gross Weight (Kg)	Net Weight (kg)
			L Length	W Width	D Depth			L Length	W Width	H Height			
FL1L2DR20P	Blister Pack	2R20P	292	158	64	313	24	46	31.5	31	0.0449	9.0	7.5
FL1L2DD12	Display box	—	250	188	195	1332	4	51.5	40	21.5	0.0443	7.0	5.3
FL1L2C2R14P	Blister Pack	2R14P	240	131	50	170	24	47	26	20	0.0244	4.1	5.0
FL1L2AA2R6P	Blister Pack	2R6P	211	99	38	84	60	40	30	23	0.0276	6.0	5.3
FL1L2AAD24	Display box	—	230	154	150	1116	8	24	33	32.5	0.0515	10.5	8.9

Rechargeable Flashlight

Maximum Illumination and Durable Design



Rechargeable Aluminum Flashlight

- 200 meters effective lighting range, up to 5 km visibility
- Anodized aircraft aluminum alloy
- Shock resistant and weatherproof
- Up to 1000 recharge cycle
- Concealed recharge socket
- Easy grip with anti-roll design

Model#	Flashlight Specifications							Charger Specification		
	LED Type	LEDs	Battery Mode	Body Material	Available Colors	Water Resistant (Y/N)	Operating Time	Input	Ouput	Charging Time
RT396	CREE® XP-E 3W LED	1	Lithium-ion 18650	Aircraft aluminum	■ Black	Y	4 hrs	/	/	6 hrs
RT397	CREE® XR-E 3W LED	1	3 x NC-D2500	Aircraft aluminum	■ Black	Y	8 hrs	100-240~50/60Hz	4.2 --- 500mA	6 hrs
RT398	CREE® XR-E 3W LED	1	3 x NC-C2500	Aircraft aluminum	■ Black	Y	8 hrs	100-240~50/60Hz	4.2 --- 500mA	6 hrs

 **3 WATT LED CREE® XP-E**

RT396

**Up to
9 Hrs**
Continuous
use



RT396-18650CB

 **3 WATT LED CREE® XR-E**

3 Lighting Modes



RT397

**Up to
8 Hrs**
Continuous
use



RT397-3NC-D2500CB



Rechargeable



Aircraft
aluminum



High
Illumination

RT398

**Up to
8 Hrs**
Continuous
use



RT398-3NC-C2500CB

Packaging Details

Item#	Packaging Type	Batteries Included	Box Details				Outer Carton Details						
			Dimensions (mm)			Net Weight (g)	Packs/ Carton	Dimensions (cm)			Volume (M ³)	Gross Weight (Kg)	Net Weight (kg)
			L Length	W Width	D Depth			L Length	W Width	H Height			
RT396-18650CB	Box	Li-ion 18650	170	138	58	/	24	44	36	26	0.0412	5.7	5.1
RT397-3NC-D2500CB	Box	3NC-D2500	316	145	65	992	8	33.1	30.5	27.8	0.0281	8.2	7.9
RT398-3NC-C2500CB	Box	3NC-C2500	256	125	55	650	8	27.1	26.5	23.8	0.0171	5.5	5.2

Rechargeable Flashlight

Ideal Lighting for Home and Outdoors



Rechargeable LED Flashlight

- Built in rechargeable battery
- Easy charging with retractable plug on the flashlight
- LED light source
- Long continuous operating time
- Dual lighting modes (3/6 beam selector on model RHP6062)

Flashlight Specifications								
Model #	LEDs	LED Type	Milli Candela	Battery Mode	Body Material	Available Colors	Water Resistant (Y/N)	Operating Time
RHP6041	4	Super Bright LED	1850 mcd	Lead Acid	Plastic	<div style="display: flex; gap: 5px;"> Yellow Black </div>	N	20 hrs
RHP6062	6	Super Bright LED	1850 mcd	Lead Acid	Plastic	<div style="display: flex; gap: 5px;"> Yellow+Black </div>	N	3LEDs: 24 hrs 6LEDs: 15 hrs

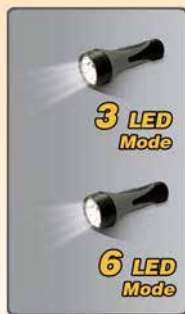

RHP6041



RHP6041BP

Directions

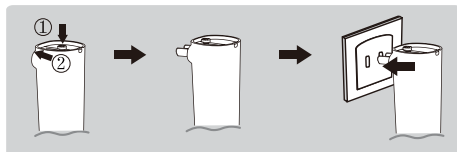

RHP6062

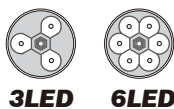

RHP6062BP

Packaging Details

Item#	Packaging Type	Batteries Included	Blister/Box Details					Outer Carton Details					
			Dimensions (mm)			Net Weight (g)	Packs/ Carton	Dimensions (cm)			Volume (M ³)	Gross Weight (Kg)	Net Weight (kg)
			L Length	W Width	D Depth			L Length	W Width	H Height			
RHP6041BP	Blister Pack	Lead Acid	240	103	57	170	48	54.5	50.5	26	0.0716	9.1	8.1
RHP6062BP	Blister Pack	Lead Acid	285	110	63	198	48	56.5	56	31.5	0.0997	10.9	9.5

Spotlight

For Home and Outdoors



2-IN-1 Spotlight

- 3W high power LED and duo color COB
- 2-IN-1 multi-function lighting
- Five different lighting modes (Low Beam/ High Beam/ White Light/ Red Light/ Red Flashing)
- Two-position side handle with a folding tail handle



LED Spotlight

- Cloverleaf reflector designed for maximum focus and light intensity
- Powerful lighting distance up to 150 meters
- Long continuous operating time
- LED light source
- Handy with hooks and anti-roll design

Model#	Specifications						
	LEDs	LED Type	Luminous Flux	Battery Mode	Body Material	Available Colors	Water Resistant (Y/N)
S32	2	3W White LED+ 3W duo color COB	230Lm	3 x AA	Plastic	Black	Y
FL-16LED	16	Super Bright LED	60Lm	4 x D	Plastic	Yellow	Y
FL-9LED	9	Super Bright LED	35Lm	4 x AA	Plastic	Yellow	Y
CM25L	1	OSRAM S5	90Lm	4 x D	Plastic	Yellow	Y

5 Lighting Modes

LED Spotlight Modes:



COB Area Lantern Modes:



S32



S32-3R6PCB

 **16LED**

FL-16LED

**Up to
500 Hrs**
Continuous
use



FL-16LED-4R20PCB



FL-16LED-4R20P

 **9LED**

FL-9LED

**Up to
150 Hrs**
Continuous
use



FL-9LED-4R6P

 **1LED**

CM25L

**Up to
70 Hrs**
Continuous
use



CM25L-4R25

Packaging Details

Item#	Packaging Type	Batteries Included	Blister/Box Details					Outer Carton Details					
			Dimensions (mm)			Net Weight (g)	Packs/ Carton	Dimensions (cm)			Volume (M ³)	Gross Weight (Kg)	Net Weight (kg)
			L Length	W Width	D Depth			L Length	W Width	H Height			
S32-3R6PCB	Box	3 x AA	185	105	148	350	6	38.5	33	168	0.0214	2.6	2.35
FL-16LED-4R20PCB	Box	4 x D	250	123	135	708	12	51	38	28.5	0.0552	9.1	8.5
FL-16LED-4R20P	Shrink Pack	4 x D	250	120	132	695	12	51	37	28	0.0528	8.9	8.3
FL-9LED-4R6P	Shrink Pack	4 x D	100	146	110	278	36	59	54	24	0.0765	12.0	10
CM25L-4R25	Shrink Pack	4 x D	255	110	115	800	12	53	32.5	28.5	0.0491	12.5	9.6

Lantern

Ideal Lighting for Home and Outdoors



LED Lantern

- 360° effective lighting
- LED lighting of outstanding illumination and high energy efficiency
- Easy grip design with adjustable handle and hook
- Non-topple base
- Different lighting modes

Specifications							
Model#	LEDs	LED Type	Luminous Flux	Battery Mode	Body Material	Available Colors	Water Resistant (Y/N)
SL2011	1	0.5W LED	55Lm	4 x AA	Plastic	<div style="display: flex; gap: 5px;"> ■ Yellow ■ Red </div>	N
SL1011N	5	0.5W LED	200Lm	3 x D	Plastic	<div style="display: flex; gap: 5px;"> ■ Yellow ■ Green </div>	Y



SL2011



55 lumens

Up to 50,000
Hours LED Lifetime

360°
Effective Lighting



SL2011-4R6PCB



SL2011-4R6PD6



SL1011N



3 Mode
Lighting Modes

Up to 50,000
Hours LED Lifetime

Effective Lighting 360°
Degree Lighting



SL1011N-CB

Packaging Details													
Item#	Packaging Type	Batteries Included	Box/Display					Outer Carton Details					
			Dimensions (mm)			Net Weight (g)	Packs/ Carton	Dimensions (cm)			Volume (M ³)	Gross Weight (Kg)	Net Weight (kg)
			L Length	W Width	D Depth			L Length	W Width	H Height			
SL2011-4R6P-CB	Box	4R6P	352	240	295	244	24	46.8	35.5	30.0	0.0499	6.3	5.66
SL2011-4R6PD6	Display Box	4R6P	340	227	138	/	12	47	36.4	16	0.0274	2.4	3.29
SL1011N-CB	Box	3LR20	125	125	205	600	12	43.4	27.2	40.5	0.0478	8.6	7.2

Rechargeable Lantern

LED Lantern for Home and Outdoors



Rechargeable LED Lantern

- LED light source providing outstanding illumination
- 360° effective lighting with light diffuser
- Built in rechargeable battery
- Adjustable handle with hook
- Two lighting mode of night light and full beam lighting (model RS650)

Flashlight Specifications								
Model #	LEDs	LED Type	Luminous Flux	Battery Mode	Body Material	Available Colors	Water Resistant (Y/N)	Operating Time
RS650	1	1W LED	70Lm	Lead Acid	Plastic	<div style="display: flex; gap: 5px;"> Yellow Green </div>	N	6 hrs
RS651	1	0.5W LED	55Lm	Li-ion 18650	Plastic	<div style="display: flex; gap: 5px;"> Yellow Red </div>	N	10 hrs



RS650

up to **120** hours² continuous lighting

2 Mode Lighting Modes

Up to **50,000** Hours LED Lifetime

Efficient Lighting **360°** Effective Lighting



RS650



RS651

up to **10** hours continuous lighting

55 lumens

Up to **50,000** Hours LED Lifetime

360° Effective Lighting



RS651-18650CB

Packaging Details

Item#	Packaging Type	Batteries Included	Box Details					Outer Carton Details					
			Dimensions (mm)			Net Weight (g)	Packs/ Carton	Dimensions (cm)			Volume (M ³)	Gross Weight (Kg)	Net Weight (kg)
			L Length	W Width	D Depth			L Length	W Width	H Height			
RS650	Box	Lead Acid	125	125	205	523	12	43.4	27.2	40.5	0.0478	7.0	6.4
RS651-18650CB	Box	Li-ion 18650	112	112	13.8	231	12	35.2	24	29.5	0.025	3.1	2.3



Work Light

Ideal Lighting for Workplace



Work Light

- Powerful 3W COB LED illumination
- 360o rotatable bracket, can adjust to any direction, convenient to hand carry or put on table
- Special coating applied, a better outlook and smoother to handle
- Long Lifespan COB: needs no replacement, extremely energy saving
- Outstanding illumination provided by 3W COB LED
- Strong magnet button and swivel hook
- Durable rubberized ABS casing for better comfort

Model#	LED Type	Luminous Flux	Battery Mode	Body Material	Available Colors	Water Resistant (Y/N)
S31	3W COB LED	200Lm	4x AAA	Plastic	 Black	N
SL5240N	3W COB LED	220Lm	3 x AA	Plastic	 Black+Red	N
SL7280N	3W COB LED	200Lm	3 x AAA	Plastic	 Black+Red	N

S31 3W COB LED

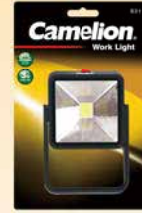
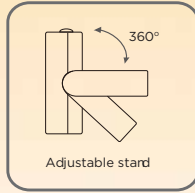
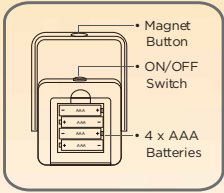

S31-4LR03TB



S31-D12



SL5240N 3W COB LED



SL5240N-BP



SL5240N-3R6PD12



SL7280N 3W COB LED



SL7280N-BP



SL7280N-3R03PD12

Packaging Details

Item#	Packaging Type	Batteries Included	Blister/Display Details					Outer Carton Details						
			Dimensions (mm)			Net Weight (g)	Packs/ Carton	Dimensions (cm)			Volume (M ³)	Gross Weight (Kg)	Net Weight (kg)	
			L Length	W Width	D Depth			L Length	W Width	H Height				
S31-4LR03TB	Blister Pack	4LR03	305	235	150	8	48	49	32.5	32.5	0.0518	8.58	6.9	
S31-D12	Display Box	----	320	170	132	1480	48	36	34	29	0.0365	6.3	5.9	
SL5240N-BP	Blister Pack	----	395	125	32	182	24	40.5	27.5	32	0.0357	4.67	4.37	
SL5240N-3R6PD12	Display Box	3R6P	202	227	210	1750	4	49	24	46	0.0541	9.0	7.0	
SL7280N-BP	Blister Pack	----	202	125	40	94	48	58	36.5	22.5	0.0477	5.5	4.5	
SL7280N-3R03PD12	Display Box	3R03P	143	232	108	1050	4	32.5	32	21.5	0.0224	5.0	4.2	

Work Light

Ideal Lighting for Workplace

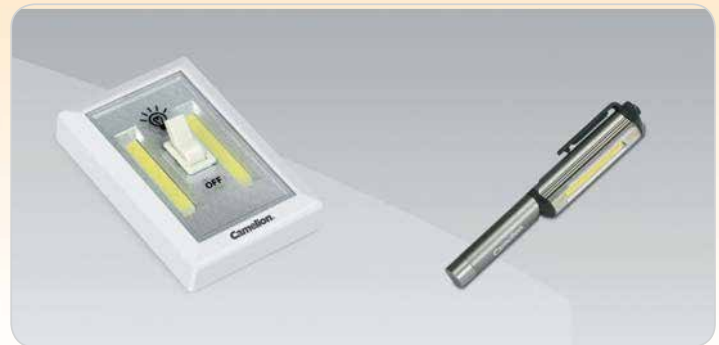

Switch Light

- Powerful lighting provided with two 3W COB LED
- Choice of installation with magic tape, screws or magnet
- Non replace needed LEDs
- Uses widely available AAA batteries

LED Pen Work Light

- Powerful 3W COB lighting
- Durable CNC-machined aluminum alloy body
- Rotatable magnetic clip
- None replace needed LED of up to 50,000 hours lifespan

Specifications							
Model#	LEDs	LED Type	Luminous Flux	Battery Mode	Body Material	Available Colors	Water Resistant (Y/N)
S35	2	3W COB LED	250Lm	4 x AAA	Plastic	☐ White	N
S28	2	3W COB LED	250Lm	4 x AAA	Plastic	☐ White	N
T11	1	3W COB LED	200Lm	3 x AAA	Plastic	■ Blue ■ Red ■ Silver	N

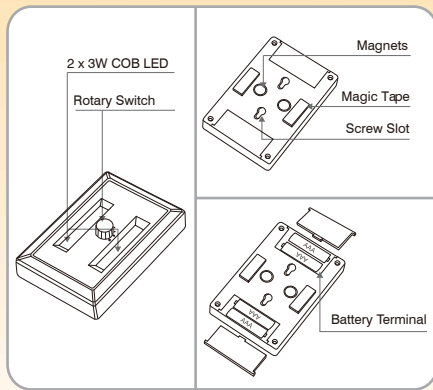

S35 3W COB LED



S35-4R03PD12

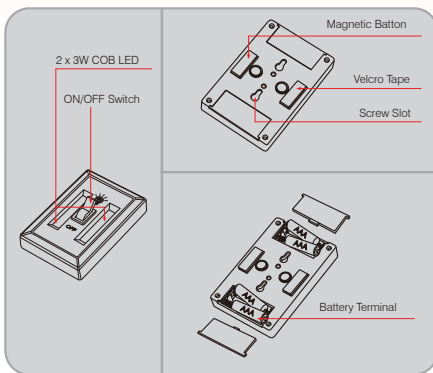

S28 3W COB LED



S28-4R03PD12

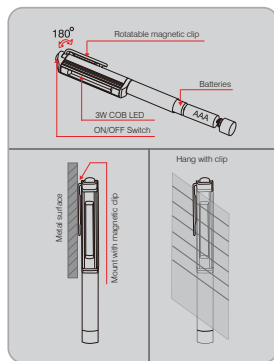

T11 3W COB LED



T11-D12

Packaging Details

Item#	Packaging Type	Batteries Included	Display Details				Outer Carton Details						
			Dimensions (mm)			Net Weight (g)	Packs/ Carton	Dimensions (cm)			Volume (M ³)	Gross Weight (Kg)	Net Weight (kg)
			L Length	W Width	D Depth			L Length	W Width	H Height			
S35-4R03PD12	Display Box	4R03P	280	195	118	1785	4	40.5	29.5	25.6	0.0306	6.5	5
S28-4R03PD12	Display Box	4R03P	280	195	118	1785	4	40.5	29.5	25.6	0.0306	6.5	5
T11-D12	Display Box	3R03P	106	141	165	1321	48	31	24.4	18.7	0.0142	4.32	4

Rechargeable Work Light

Ideal Lighting for Workplace



LED Work Light

- Five lighting modes: High beam / normal beam / Low beam / Flashing / SOS.
- Gentle and white light to protect your eyes.
- Power indicator: Easy to check when charging or using.
- Over-charge, Over-discharge and Short-circuit.
- Universal Micro-USB Input and Output Socket.

Specifications							
Model#	LEDs	LED Type	Luminous Flux	Battery Mode	Body Material	Available Colors	Water Resistant (Y/N)
S20	1	8W COB LED	500Lm	Li-ion 18650 3.7V, 4000mAh	Plastic	Black	Y
RS60	1	10W	400Lm	Li-ion 18650 3.7V, 2000mAh	Plastic	Black	N

S20 Rechargeable Work Light



S20-CB



RS60



Packaging Details

Item#	Packaging Type	Batteries Included	Display Details				Outer Carton Details						
			Dimensions (mm)			Net Weight (g)	Packs/ Carton	Dimensions (cm)			Volume (M ³)	Gross Weight (Kg)	Net Weight (kg)
			L Length	W Width	D Depth			L Length	W Width	H Height			
S20-CB	Box	4R03P	205	75	240	600	12	47.5	43	26	0.519	8.5	7.2
RS60-CB	Box	Li-ion 18650	385	45	40	230	24	40	28.5	18	0.0205	5.9	5.52

Rechargeable Work Light



Ideal Lighting for Workplace



LED Work Light

- High power COB light source
- Powered by rechargeable lithium-ion batteries
- Portable and lightweight
- Weatherproof
- Adjustable

Specifications

Model#	LEDs	LED Type	Luminous Flux	Battery Mode	Body Material	Available Colors	Water Resistant (Y/N)
S21	1	10W COB LED	800Lm	Li-ion 18650 7.4V 2200mAh	Plastic	 Yellow	Y
S22	1	20W COB LED	1600Lm	Li-ion 18650 7.4V 4400mAh	Plastic	 Red	Y

S21

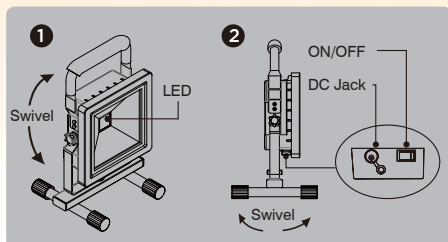

S21-CB

S22



S22-CB

Packaging Details

Item#	Packaging Type	Batteries Included	Display Details				Outer Carton Details						
			Dimensions (mm)			Net Weight (g)	Packs/ Carton	Dimensions (cm)			Volume (M ³)	Gross Weight (Kg)	Net Weight (kg)
			L Length	W Width	D Depth			L Length	W Width	H Height			
S21-CB	Box	Li-ion 18650	130	110	225	1100	12	45.5	40.5	24.5	0.0451	14.2	13.2
S22-CB	Box	Li-ion 18650	170	120	270	1600	10	61.5	35.5	29	0.0633	17	16

Safety Light

Ideal Lighting for Riders



Safety Light

- High bright LED light source
- Durable silicon straps
- Multiple lighting modes
- Easy mount

Aluminum Safety Light

- High bright LED light source
- Durable aluminum casing
- Weather and slip resistant
- Three lighting modes
- Easy mount
- Long continuous lighting time

Specifications							
Model#	LEDs	LED Type	Luminous Flux	Battery Mode	Body Material	Available Colors	Water Resistant (Y/N)
S48	1	0.6W COB	40Lm	Li-polymer	ABS+PMMA	Red	Y
RS652	4	Super Bright LED	20Lm	Li-polymer	ABS + PS + silicon	Red White	Y
S53	2	2×0.5W 2835 LED	20Lm	2×CR2032	ABS+ Silicone	Red+Black	Y
S767	1	Super Bright LED	5Lm	2 x CR2032	Aluminum + silicon	Red Black	Y
T556S	1	CREE® XP-E LED	120Lm	3 x AAA	Aircraft aluminum	Black	Y



S48
Rechargeable
Safety Light



S48-BP1



RS652
Rechargeable
Safety Light



RS652-BP



S53



S53-2CR2032BP



S767



S767-2CR2032BP

Directions



3 lighting modes with red alarm ring

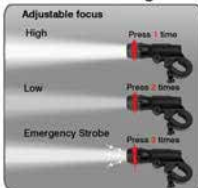

T556S



1LED



T556S-3LR03DB

Packaging Details

Item#	Packaging Type	Batteries Included	Blister/Details					Outer Carton Details					
			Dimensions (mm)			Net Weight (g)	Packs/ Carton	Dimensions (cm)			Volume (M ³)	Gross Weight (Kg)	Net Weight (kg)
			L Length	W Width	D Depth			L Length	W Width	H Height			
S48-BP1	Blister Pack	Li-polymer	111	172	30	52	48	38.5	37.5	27	0.0390	3.4	2.5
RS652-BP	Blister Pack	Li-polymer	111	172	27	34	48	42	35.5	20	0.0299	2.6	1.6
S53-2CR2032BP	Blister Pack	2CR2032	111	172	48	85	48	37.5	34.5	27	0.0349	5.0	4.1
S767-2CR2032BP	Blister Pack	2CR2032	111	172	42	28	48	56	29.5	20	0.0331	2.4	1.4
T556S-3LR03DB	Double Blister	3LR03	222	128	42	184	24	57.5	32.5	29	0.0542	9.6	8.8

Safety Light

Ideal Lighting for Riders



Safety Light

- Super Bright LED light source
- Adjustable angle
- Three lighting modes
- Weather and slip resistant
- Easy mount and dismount
- Long continuous operating time

Specifications							
Model#	LEDs	LED Type	Luminous Flux	Battery Mode	Body Material	Available Colors	Water Resistant (Y/N)
S760	2	Super Bright LED	8Lm	2 x CR2032	Silicon	■ Red White	Y
S766	5	Super Bright LED	20Lm	3 x AAA	Silicon	■ Red White	Y
S765	3	Super Bright LED	10Lm	2 x AAA	Plastic	 Black	Y
S769	5	Super Bright LED	20Lm	4 x AAA	Plastic	 Black	Y
S771	3	Super Bright LED	10Lm	2 x AAA	Plastic	 Red+Black	Y



S760



2LED



S760-2CR2032BP2



S760-2CR2032-PB30

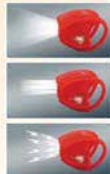

S766



5+2LED



S766-3R03PBP

Laser Light



S765



S765-2LR03BP

3 Lighting Modes



Constant



Flashing



Strobe

S769



S769-4LR03BP

3 Lighting Modes



Constant



Flashing



Strobe

S771



S771-2LR03BP

Packaging Details

Item#	Packaging Type	Batteries Included	Blister/Details				Outer Carton Details						
			Dimensions (mm)			Net Weight (g)	Packs/ Carton	Dimensions (cm)			Volume (M ³)	Gross Weight (Kg)	Net Weight (kg)
			L Length	W Width	D Depth			L Length	W Width	H Height			
S760-2CR2032BP2	Blister Pack	2CR2032	202	125	35	94	48	46	25.5	28	0.0329	4.95	4.5
S760-2CR2032-PB30	Fish Bowl	2CR2032	130	110	150	718	12	41	24.5	34.5	0.0347	9.4	8.6
S766-3R03PBP	Blister Pack	3R03P	111	172	35	60	48	35	31	19	0.0207	3.5	3.0
S765-2LR03BP	Blister Pack	2LR03	125	202	32	115	48	44.0	43.0	22.5	0.0426	6.5	5.5
S769-4LR03BP	Blister Pack	4LR03	125	202	42	170	48	56.0	44.5	22.5	0.0561	9.2	8.2
S771-2LR03BP	Blister Pack	2LR03	125	202	38	82	48	51.0	45.0	22.5	0.0517	4.9	3.9

Home Lighting

Ideal Lighting for Household



Sensor Light

- Wide Sensory Angles
- Long sensory distance
- Powerful LED light source
- Choice of installation by adhesive plate or magnet

Tap Light

- Easy to install and operate
- Adequate brightness and soft lighting
- Energy saving
- Up to 100 hours of continuous lighting

Specifications

Model#	Bulb Type	Luminous Flux	Battery Mode	Body Material	Available Colors	Water Resistant (Y/N)
S50	3W COB	150Lm	3 x AAA	ABS	<input type="checkbox"/> White	N
SL7018	Super Bright LED	15Lm	3 x AA	Plastic	<input type="checkbox"/> White	N
SL7019	Super Bright LED	15Lm	3 x AAA	Plastic	<input type="checkbox"/> White	N
SL7015	Super Bright LED	5Lm	3 x AAA	Plastic	<input type="checkbox"/> Magenta <input type="checkbox"/> Yellow <input type="checkbox"/> Green <input type="checkbox"/> Blue	N



S50



S50-3R03P



SL7018



SL7018-3LR6TB

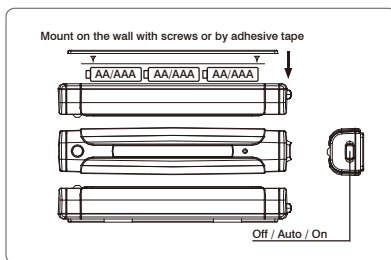

SL7019



SL7019-3LR03TB



SL7015



SL7015-3LR03D24

Packaging Details

Item#	Packaging Type	Batteries Included	Blister/Display Details				Outer Carton Details						
			Dimensions (mm)			Net Weight (g)	Packs/ Carton	Dimensions (cm)			Volume (M ³)	Gross Weight (Kg)	Net Weight (kg)
			L Length	W Width	D Depth			L Length	W Width	H Height			
S50-3R03P	Display box	3LR03	286	156	85	82	48	33	30.2	19	0.0190	5.14	3.94
SL7018-3LR6TB	Blister Pack	3LR6	305	125	35	234	24	36.5	26.2	34	0.0325	6.3	5.6
SL7019-3LR03TB	Blister Pack	3LR03	305	125	32	199	48	54	30	28	0.0450	8.4	7.4
SL7015-6R03PBP2	Blister Pack	3LR03	40	222	167	196	24	46	41.5	18.7	0.0357	6.0	4.7
SL7015-3LR03D24	Display box	3LR03	342	258	87	1990	48	37	28	20.5	0.0468	4.6	3.4

Professional Lighting

Specialized lighting



Head Light

- Powerful LED light source
- Multiple lighting modes
- Adjustable Angle head light
- Flexible headband



Pen Light

- Powerful spot beam
- Durable aircraft aluminum
- Strong pocket clip
- Push button switch

Specifications

Model#	Bulb Type	Luminous Flux	Battery Mode	Body Material	Available Colors	Water Resistant (Y/N)
S51	5W XP-G LED and 2x3W COB	200Lm	3 x AAA	ABS	■ Black	N
S58	3W COB	120Lm	3 x AAA	ABS	■ Black	N
DL2AAAS	Vacuum	5Lm	2 x AAA	Aircraft aluminum	□ Silver	N
DL2AAASL	LED	15Lm	2 x AAA	Aircraft aluminum	□ Silver	N



S51



S51-3LR03DB



S58



S58-3LR03DB

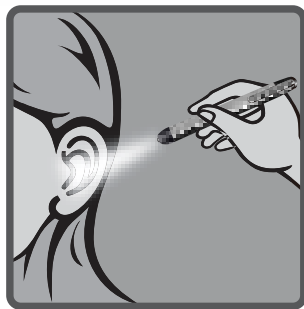

Powered by 2 x AAA batteries

DL2AAAS



DL2AAAS



Powered by 2 x AAA batteries

DL2AAASL



DL2AAASL

Packaging Details

Item#	Packaging Type	Batteries Included	Blister/Details					Outer Carton Details					
			Dimensions (mm)			Net Weight (g)	Packs/ Carton	Dimensions (cm)			Volume (M ³)	Gross Weight (Kg)	Net Weight (kg)
			L Length	W Width	D Depth			L Length	W Width	H Height			
S51-3LR03DB	Blister Pack	3LR03	128	178	83	111.5	48	55	45.5	35	0.0876	6.3	5.35
S58-3LR03DB	Blister Pack	3LR03	128	178	67	99.5	48	55	43.5	30.5	0.0730	5.7	4.78
DL2AAAS	Blister Pack	2R03P	195	90	21	56	100	48.5	39	25	0.0479	7.0	5.6
DL2AAASL	Blister Pack	2R03P	195	90	21	56	100	48.5	39	25	0.0479	7.0	5.6