



■ Features

- Compliance to EN50155 and EN45545-2 railway standard
- Ultra compact and 1U low profile(25mm)
- 4:1 wide input range
- No minimum load required
- Protections: Short circuit / Overload / Over voltage / Input reverse polarity
- 4000VDC I/O isolation (Reinforced isolation)
- Half encapsulated , cooling by free air convection
- -40~+70°C wide working temperature
- Built-in constant current limiting circuit
- LED indicator for power on
- 3 years warranty

■ Applications

- Bus, tram, metro or railway system
- Highly vibrating, highly dusty, extremely low or high temperature harsh environment
- Wireless network
- Telecom or datacom system
- Industry control system

■ Description

RSD-60 is a 60W enclosed type DC-DC reliable railway converter. This series is compliant with EN50155/ IEC60571 railway standard, constituting three types of models with 4:1 wide but different input ranges 9~36V/18~72V/40~160V, suitable for railway and all kinds of transportation systems exploiting the frequently used standard input voltages such as 12V, 24V, 36V, 48V, 72V, 96V and 110V. Various output voltages, 3.3V, 5V, 12V and 24V are available for selection.

This series has the capability of working under -40~+70°C, low ripple and noise, supreme EMC characteristics, 4KVDC I/P-OP, low enclosure profile 25mm and an interior with semi-potted silicone. It does not only well fits the in-car systems or the facilities by rails for railway, trams and buses but also can be used in the harsh environment with high vibration, high dust, extremely low or high temperature, etc.

■ Model Encoding

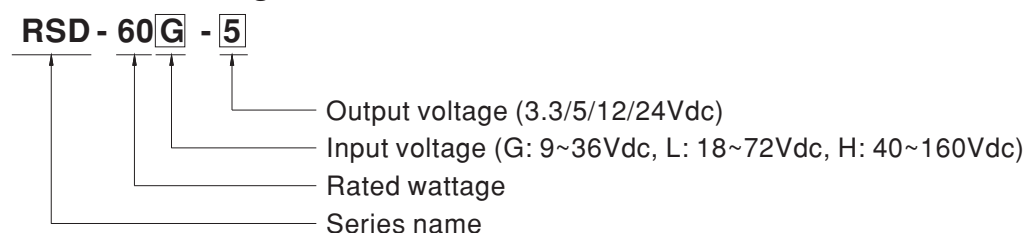



SPECIFICATION

MODEL	RSD-60G-3.3	RSD-60G-5	RSD-60G-12	RSD-60G-24	RSD-60L-3.3	RSD-60L-5	RSD-60L-12	RSD-60L-24	
OUTPUT	DC VOLTAGE	3.3V	5V	12V	24V	3.3V	5V	12V	24V
	RATED CURRENT	12A	12A	5A	2.5A	12A	12A	5A	2.5A
	CURRENT RANGE	0 ~ 12A	0 ~ 12A	0 ~ 5A	0 ~ 2.5A	0 ~ 12A	0 ~ 12A	0 ~ 5A	0 ~ 2.5A
	RATED POWER	39.6W	60W	60W	60W	39.6W	60W	60W	60W
	RIPPLE & NOISE (max.) Note.2	60mVp-p	100mVp-p	50mVp-p	50mVp-p	60mVp-p	60mVp-p	50mVp-p	50mVp-p
	VOLTAGE TOLERANCE Note.3	±2.0%	±2.0%	±2.0%	±2.0%	±2.0%	±2.0%	±2.0%	±2.0%
	LINE REGULATION	±0.5%	±0.5%	±0.3%	±0.2%	±0.5%	±0.5%	±0.3%	±0.2%
	LOAD REGULATION	±0.5%	±0.5%	±0.3%	±0.2%	±0.5%	±0.5%	±0.3%	±0.2%
	SETUP, RISE TIME	100ms, 60ms at full load							
HOLD UP TIME (Typ.)	G type comply with S1 level(3ms) @full load, S2 level(10ms) @50% load; L type comply with S2 level(10ms) @full load								
INPUT	VOLTAGE RANGE CONTINUOUS	9 ~ 36VDC				18 ~ 72VDC			
	EFFICIENCY (Typ.)	86.5%	88%	92%	90%	88.5%	89%	93%	91.5%
	DC CURRENT (Typ.)	2.1A/24VDC 3A/24VDC				0.95A/48VDC 1.5A/48VDC			
	INRUSH CURRENT (Typ.)	20A/24VDC				20A/48VDC			
PROTECTION	OVERLOAD	105 ~ 135% rated output power Protection type : Constant current limiting, recovers automatically after fault condition is removed							
	OVER VOLTAGE	4.3 ~ 4.95V	5.75 ~ 7V	13.8 ~ 16.2V	27.6 ~ 32.4V	4.3 ~ 4.95V	5.75 ~ 7V	13.8 ~ 16.2V	27.6 ~ 32.4V
ENVIRONMENT	WORKING TEMP.	-40 ~ +55°C (no derating) ; +70°C @ 60% load by free air convection ; +70°C (no derating with external base plate)							
	WORKING HUMIDITY	5 ~ 95% RH non-condensing							
	STORAGE TEMP., HUMIDITY	-40 ~ +85°C, 10 ~ 95% RH non-condensing							
	TEMP. COEFFICIENT	±0.03%/°C (0 ~ 50°C)							
	VIBRATION	10 ~ 500Hz, 5G 10min./1cycle, 60min. each along X, Y, Z axes ; Mounting : compliance to IEC61373							
SAFETY & EMC (Note 4)	SAFETY STANDARDS	EAC TP TC 004 approved, IEC60950-1 (LVD)							
	WITHSTAND VOLTAGE	I/P-O/P:4KVDC I/P-FG:2.5KVDC O/P-FG:2.5KVDC							
	ISOLATION RESISTANCE	I/P-O/P, I/P-FG, O/P-FG:100M Ohms / 500VDC / 25°C / 70% RH							
	EMC EMISSION	Parameter	Standard			Test Level / Note			
		Conducted	EN55032			Class A			
		Radiated	EN55032			Class B			
		Harmonic Current	EN6100-3-2			Class A			
		Voltage Flicker	EN6100-3-3			-----			
	EMC IMMUNITY	Parameter	Standard			Test Level / Note			
		ESD	EN61000-4-2			Level 3, ±8KV air ; Level 3, ±6KV contact			
Radiated Field		EN61000-4-3			Level X				
EFT / Burst		EN61000-4-4			Level 3, 2KV at power Level 4, 2KV at signal				
Surge		EN61000-4-5			Level 3, 1KV Line-Line, Level 3, 2KV Line-Earth				
Conducted		EN61000-4-6			Level 3				
RAILWAY STANDARD	Compliance to EN45545-2 for fire protection ; EN50155 / IEC60571 including IEC61373 for shock & vibration, EN50121-3-2 for EMC								
OTHERS	MTBF	593.8K hrs min. MIL-HDBK-217F (25°C)							
	DIMENSION	128*60*25mm (L*W*H)							
	PACKING	0.29Kg; 48pcs/14.9Kg/0.76CUFT							
NOTE	<ol style="list-style-type: none"> All parameters NOT specially mentioned are measured at 24,48VDC input, rated load and 25°C of ambient temperature. Ripple & noise are measured at 20MHz of bandwidth by using a 12" twisted pair-wire terminated with a 0.1uf & 47uf parallel capacitor. Tolerance : includes set up tolerance, line regulation and load regulation. The power supply is considered a component which will be installed into a final equipment. All the EMC tests are been executed by mounting the unit on a 360mm*360mm metal plate with 1mm of thickness. The final equipment must be re-confirmed that it still meets EMC directives. For guidance on how to perform these EMC tests, please refer to "EMI testing of component power supplies." (as available on http://www.meanwell.com) Strongly recommended that external output capacitance should not exceed 5000uF. The ambient temperature derating of 3.5°C/1000m with fanless models and of 5°C/1000m with fan models for operating altitude higher than 2000m(6500ft). 								



SPECIFICATION

MODEL	RSD-60H-3.3	RSD-60H-5	RSD-60H-12	RSD-60H-24	
OUTPUT	DC VOLTAGE	3.3V	5V	12V	24V
	RATED CURRENT	12A	12A	5A	2.5A
	CURRENT RANGE	0 ~ 12A	0 ~ 12A	0 ~ 5A	0 ~ 2.5A
	RATED POWER	39.6W	60W	60W	60W
	RIPPLE & NOISE (max.) Note.2	80mVp-p	60mVp-p	50mVp-p	50mVp-p
	VOLTAGE TOLERANCE Note.3	±2.0%	±2.0%	±2.0%	±2.0%
	LINE REGULATION	±0.5%	±0.5%	±0.3%	±0.2%
	LOAD REGULATION	±0.5%	±0.5%	±0.3%	±0.2%
	SETUP, RISE TIME	100ms, 60ms at full load			
	HOLD UP TIME (Typ.)	H-type comply with S2 level(10ms) @ full load			
INPUT	VOLTAGE RANGE CONTINUOUS	40 ~ 160VDC			
	EFFICIENCY (Typ.)	87.5%	89%	92.5%	91.5%
	DC CURRENT (Typ.)	0.415A/110VDC	0.62A/110V		
	INRUSH CURRENT (Typ.)	20A/110VDC			
PROTECTION	OVERLOAD	105 ~ 135% rated output power Protection type : Constant current limiting, recovers automatically after fault condition is removed			
	OVER VOLTAGE	4.3 ~ 4.95V	5.75 ~ 7V	13.8 ~ 16.2V	27.6 ~ 32.4V
		Protection type : Shut down o/p voltage, re-power on to recover			
ENVIRONMENT	WORKING TEMP.	-40 ~ +55°C (no derating) ; +70°C @ 60% load by free air convection ; +70°C (no derating with external base plate)			
	WORKING HUMIDITY	5 ~ 95% RH non-condensing			
	STORAGE TEMP., HUMIDITY	-40 ~ +85°C, 10 ~ 95% RH non-condensing			
	TEMP. COEFFICIENT	±0.03%/°C (0 ~ 50°C)			
	VIBRATION	10 ~ 500Hz, 5G 10min./1cycle, 60min. each along X, Y, Z axes ; Mounting : compliance to IEC61373			
SAFETY & EMC (Note 4)	SAFETY STANDARDS	EAC TP TC 004 approved, IEC60950-1 (LVD)			
	WITHSTAND VOLTAGE	I/P-O/P:4KVDC I/P-FG:2.5KVDC O/P-FG:2.5KVDC			
	ISOLATION RESISTANCE	I/P-O/P, I/P-FG, O/P-FG:100M Ohms / 500VDC / 25°C / 70% RH			
	EMC EMISSION	Parameter	Standard	Test Level / Note	
		Conducted	EN55032	Class A	
		Radiated	EN55032	Class B	
		Harmonic Current	EN6100-3-2	Class A	
		Voltage Flicker	EN6100-3-3	-----	
	EMC IMMUNITY	Parameter	Standard	Test Level / Note	
		ESD	EN61000-4-2	Level 3, ±8KV air ; Level 3, ±6KV contact	
		Radiated Field	EN61000-4-3	Level X	
		EFT / Burst	EN61000-4-4	Level 3, 2KV at power Level 4, 2KV at signal	
		Surge	EN61000-4-5	Level 3, 1KV Line-Line, Level 3, 2KV Line-Earth	
		Conducted	EN61000-4-6	Level 3	
RAILWAY STANDARD	Compliance to EN45545-2 for fire protection ; EN50155 / IEC60571 including IEC61373 for shock & vibration, EN50121-3-2 for EMC				
OTHERS	MTBF	593.8K hrs min. MIL-HDBK-217F (25°C)			
	DIMENSION	128*60*25mm (L*W*H)			
	PACKING	0.29Kg; 48pcs/14.9Kg/0.76CUFT			
NOTE	<ol style="list-style-type: none"> All parameters NOT specially mentioned are measured at 110VDC input, rated load and 25°C of ambient temperature. Ripple & noise are measured at 20MHz of bandwidth by using a 12" twisted pair-wire terminated with a 0.1uF & 47uF parallel capacitor. Tolerance : includes set up tolerance, line regulation and load regulation. The power supply is considered a component which will be installed into a final equipment. All the EMC tests are been executed by mounting the unit on a 360mm*360mm metal plate with 1mm of thickness. The final equipment must be re-confirmed that it still meets EMC directives. For guidance on how to perform these EMC tests, please refer to "EMI testing of component power supplies." (as available on http://www.meanwell.com) Strongly recommended that external output capacitance should not exceed 5000uF. The ambient temperature derating of 3.5°C/1000m with fanless models and of 5°C/1000m with fan models for operating altitude higher than 2000m(6500ft). 				

Block Diagram

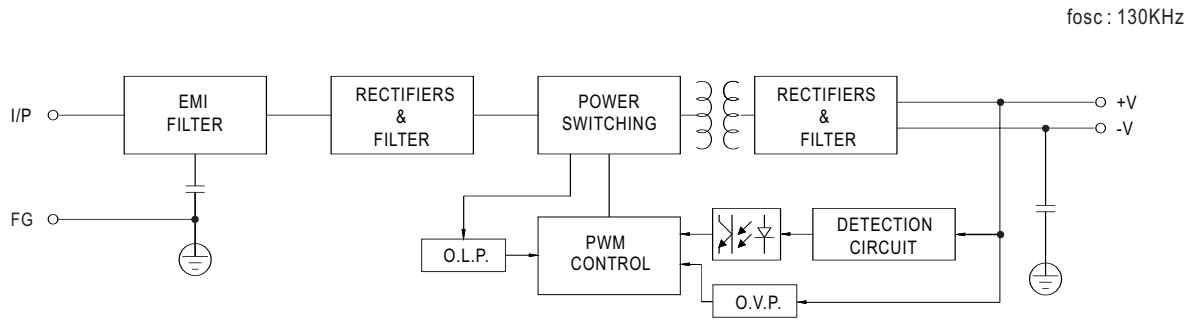

Input Fuse

There is one fuse connected in series to the positive input line, which is used to protect against abnormal surge. Fuse specifications of each model are shown as below.

Type	Fuse Type	Reference and Rating
G	Time-Lag	CONQUE MST, 10A, 250V
L	Time-Lag	CONQUE MST, 5A, 250V
H	Time-Lag	CONQUE MST, 2.5A, 250V

Input Reverse Polarity Protection

There is a MOSFET connected in series to the negative input line. If the input polarity is connected reversely, the MOSFET opens and there will be no output to protect the unit.

Input Range and Transient Ability

The series has a wide range input capability. With $\pm 40\%$ of rated input voltage, it can withstand that for 1 second.

Input Under-Voltage Protection

If input voltage drops below V_{imin} , the internal control IC shuts down and there is no output voltage. It recovers automatically when input voltage reaches above V_{imin} , please refer to the cruve below.

RSD-60G-24

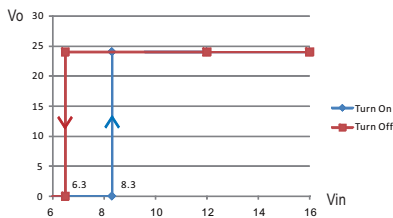

RSD-60L-24

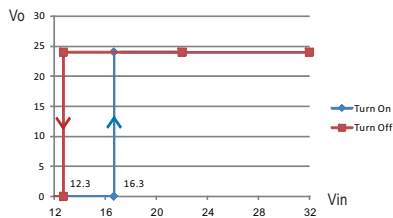

RSD-60H-24

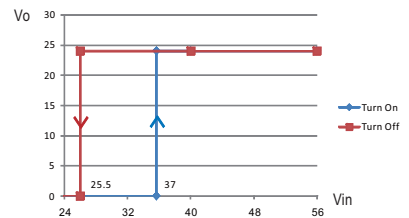

Inrush Current

Inrush current is suppressed by a resistor during the initial start-up, and then the resistor is bypassed by a MOSFET to reduce power consumption after accomplishing the start-up.

Hold-up Time

L/H type is in compliance with S2 level (10ms), while G types are in compliance with S1 level (3ms) at full load output condition. To fulfil the requirements of S2 level (10ms), G types require de-rating their output load to 50%, please refer to the curve diagrams below.

RSD-60G-3.3

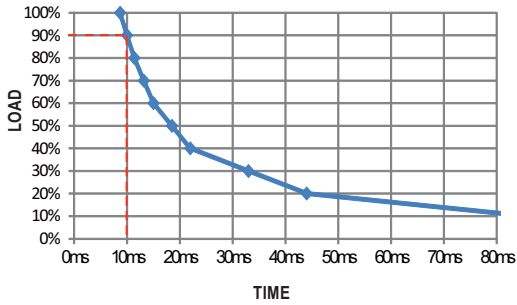

RSD-60G-5

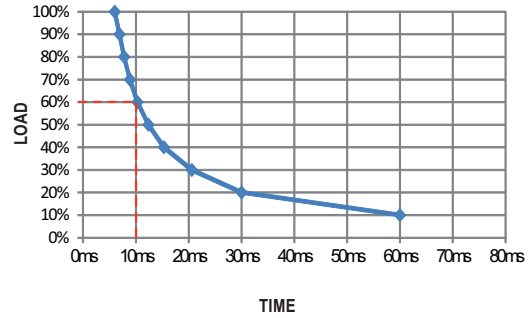

RSD-60G-12

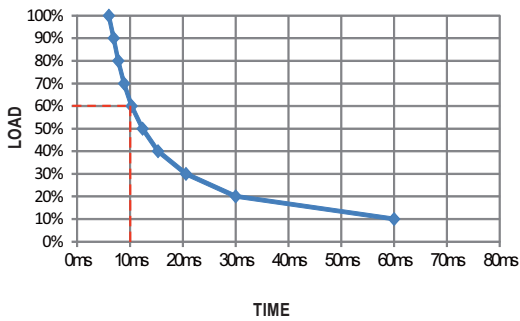

RSD-60G-24

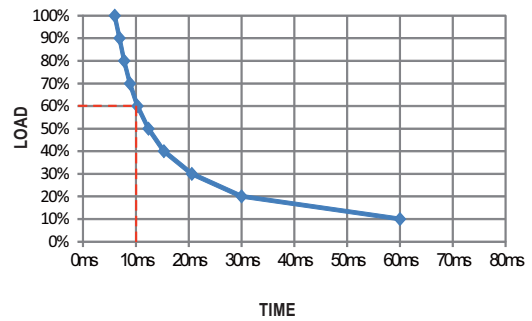

Output Voltage Adjustment

This function is optional, which the standard product does not have it. If you do need the function, please contact MW for details.

Efficiency vs Load & Vin Curve

The efficiency vs load & Vin curves of each model are shown as below.

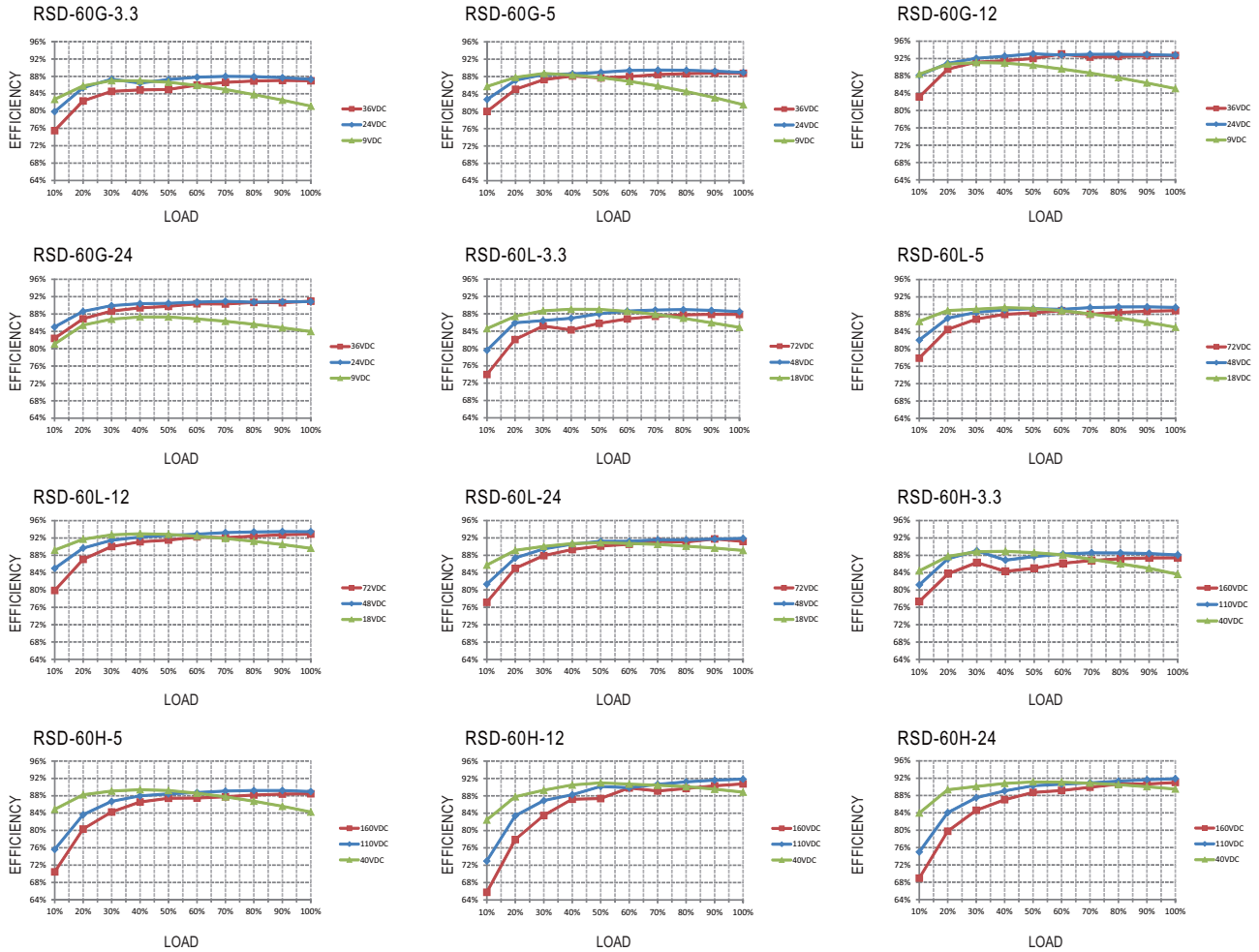

Parallel and Series Connection

A. Operation in Parallel

Since RSD-60 series don't have built-in parallel circuit, it can only use external circuits to achieve the redundant operation but not increase the current rating.

1. Add a diode at the positive-output of each power supply (as shown as below), the current rating of the diode should be larger than the maximum output current rating and attached to a suitable heat sink. This is only for redundant use (increase the reliability of the system) and users have to check suitability of the circuit by themselves.

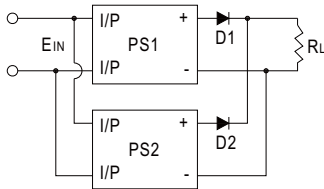

2. When using S.P.S. in parallel connection, the leakage current will increase at the same time. This could pose as a shock hazard for the user. So please contact the supplier if you have this kind of application.

B. Operation in Series

RSD-60 can be operated in series. Here are the methods of doing it:

1. Positive and negative terminals are connected as shown as below. According to the connection, you can get the positive and negative output voltages for your loads.

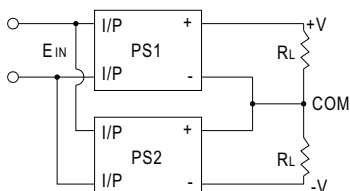

2. Increase the output voltage (current does not change). Because RSD-60 series have no reverse blocking diode in the unit, you should add an external blocking diode to prevent the damage of every unit while starting up. The voltage rating of the external diode should be larger than $V1+V2$ (as shown as below).

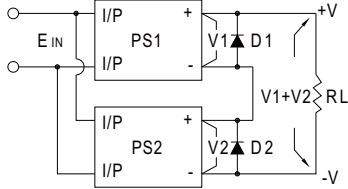

Overload Protection

If the output draw up to 105~135% of its output power rating, the converter will go into overload protection which is constant current mode. After the faulty condition is removed, it will recover automatically. Please refer to the diagram below for the detail operation characteristic. Please note that it's not suitable to operate within the overload region continuously, or it may cause to over temperature and reduce the life of the power supply unit or even damage it.

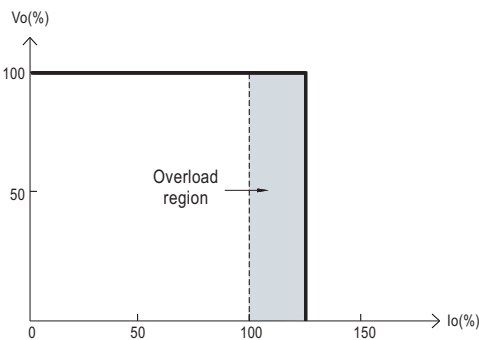

Over Voltage Protection

The converter shuts off to protect itself when the output voltage drawn exceeds 115~140% of its output rating. It must be repowered on to recover.

LED Indicator

Equipped with a built-in LED indicator, the converter provides an easy way for users to check its condition through the LED indicator.
Green : normal operation; No signal: no power or failure.

Derating Curve

a. Single unit operation

If the unit has no iron plate mounted on its bottom, the maximum ambient temperature for the unit will be 55°C as operating under full load condition. It requires de-rating output current when ambient temperature is between 55~70°C, please refer to the de-rating curve as below.

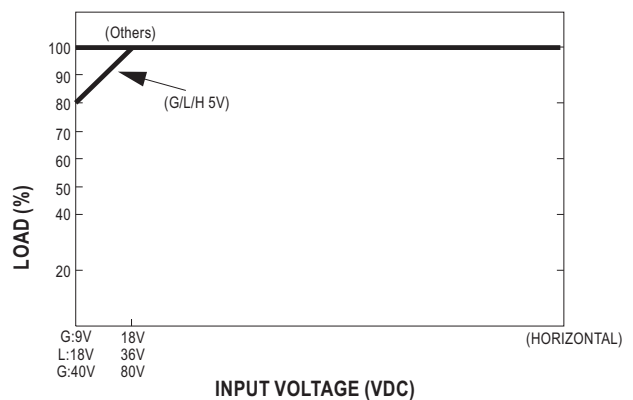
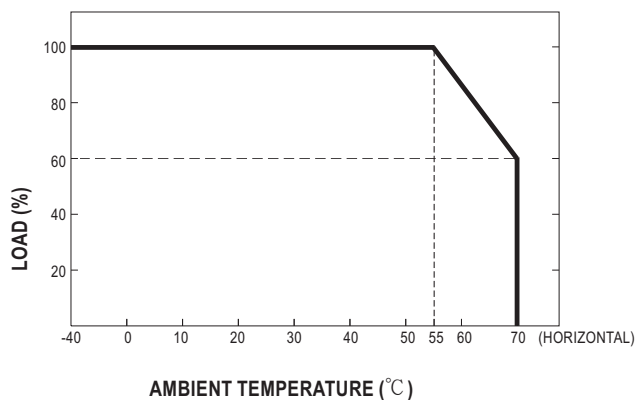

Suitable installation methods are shown as below. Since RSD-60 is a semi-potted model, its thermal performances for the following installation methods are similar and share the same derating curve.

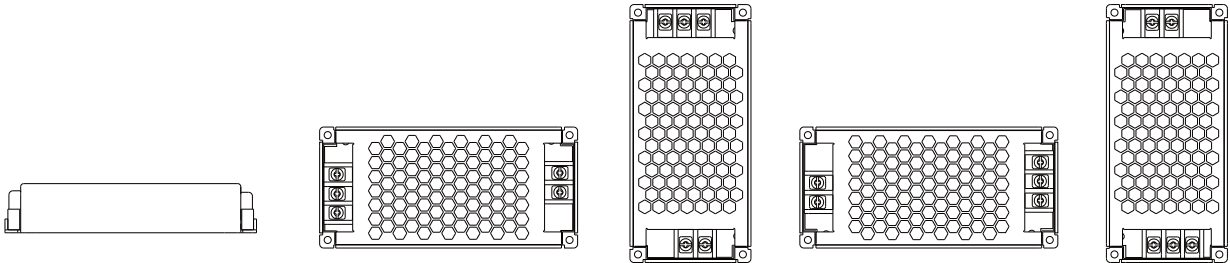

b. Operate with additional iron plate

If it is necessary to fulfil the requirements of EN50155 TX level that operate the unit fully-loaded at 70°C, RSD-60 series must be installed onto an iron plate on the bottom. The size of the suggested iron plate is shown as below. In order for optimal thermal performance, the iron plate must have an even & smooth surface and RSD-60 series must be firmly mounted at the center of the iron plate.

Unit:mm

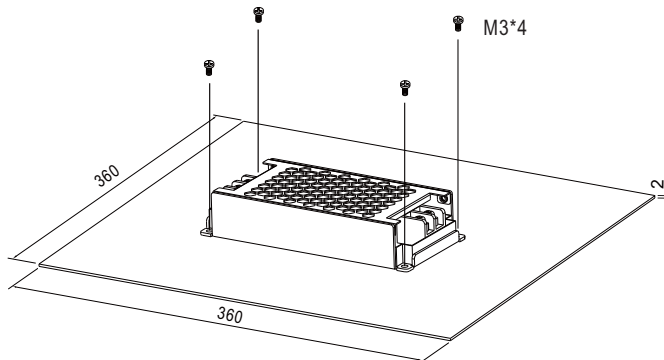

The load vs ambient temperature curve is shown as below.

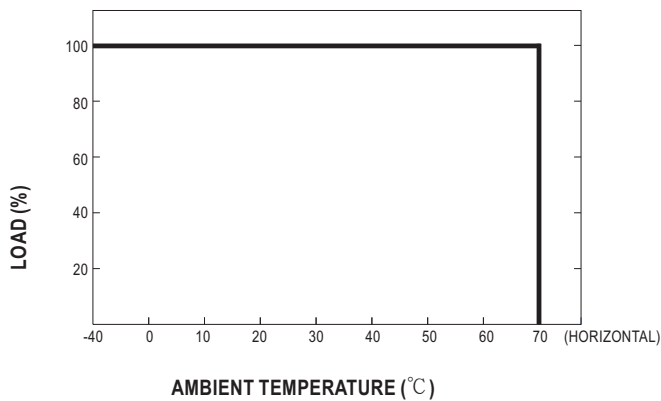

Suitable installation methods are shown as below. Since RSD-60 is a semi-potted model, its thermal performances for the following installation methods are similar and share the same derating curve.

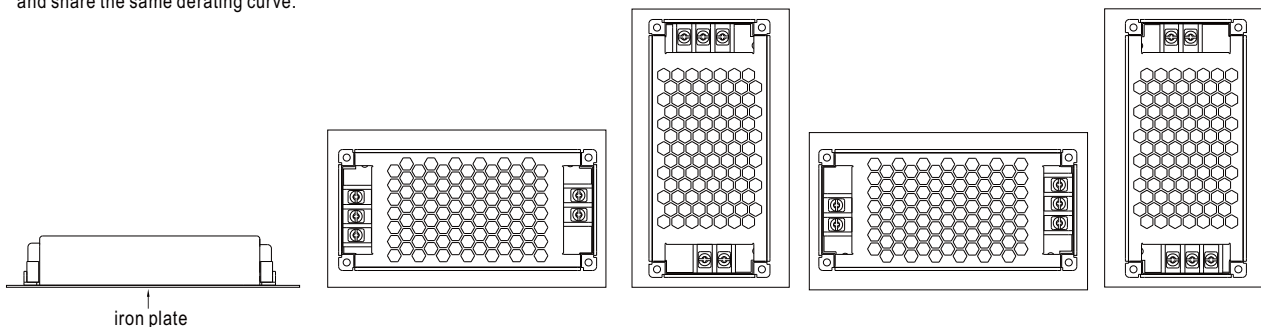

■ Immunity to Environmental Conditions

Test method	Standard	Test conditions	Status
Cooling Test	EN 50155 section 12.2.3 (Column 2, Class TX) EN 60068-2-1	Temperature: -40°C Dwell Time: 2 hrs/cycle	No damage
Dry Heat Test	EN 50155 section 12.2.4 (Column 2, Class TX) EN 50155 section 12.2.4 (Column 3, Class TX & Column 4, Class TX) EN 60068-2-2	Temperature: 70°C / 85°C Duration: 6 hrs / 10min	PASS
Damp Heat Test, Cyclic	EN 50155 section 12.2.5 EN 60068-2-30	Temperature: 25°C~55°C Humidity: 90%~100% RH Duration: 48 hrs	PASS
Vibration Test	EN 50155 section 12.2.11 EN 61373	Temperature: 19°C Humidity: 65% Duration: 10 mins	PASS
Increased Vibration Test	EN 50155 section 12.2.11 EN 61373	Temperature: 19°C Humidity: 65% Duration: 5 hrs	PASS
Shock Test	EN 50155 section 12.2.11 EN 61373	Temperature: 21 ± 3°C Humidity: 65 ± 5% Duration: 30ms*18	PASS
Low Temperature Storage Test	EN 50155 section 12.2.3 (Column 2, Class TX) EN 60068-2-1	Temperature: -40°C Dwell Time: 16 hrs	PASS
Salt Mist Test	EN 50155 section 12.2.10 (Class ST4)	Temperature: 35°C ± 2°C Duration: 96 hrs	PASS

■ EN45545-2 Fire Test Conditions

Test Items			Hazard Level		
	Items	Standard	HL1	HL2	HL3
R22	Oxygen index test	EN 45545-2:2013 EN ISO 4589-2:1996	PASS	PASS	PASS
	Smoke density test	EN 45545-2:2013 EN ISO 5659-2:2006	PASS	PASS	PASS
	Smoke toxicity test	EN 45545-2:2013 NF X70-100:2006	PASS	PASS	PASS
R24	Oxygen index test	EN 45545-2:2013 EN ISO 4589-2:1996	PASS	PASS	PASS
R25	Glow-wire test	EN 45545-2:2013 EN 60695-2-11:2000	PASS	PASS	PASS
R26	Vertical flame test	EN 45545-2:2013 EN 60695-11:2003	PASS	PASS	PASS

■ Mechanical Specification

Case No.255 Unit:mm

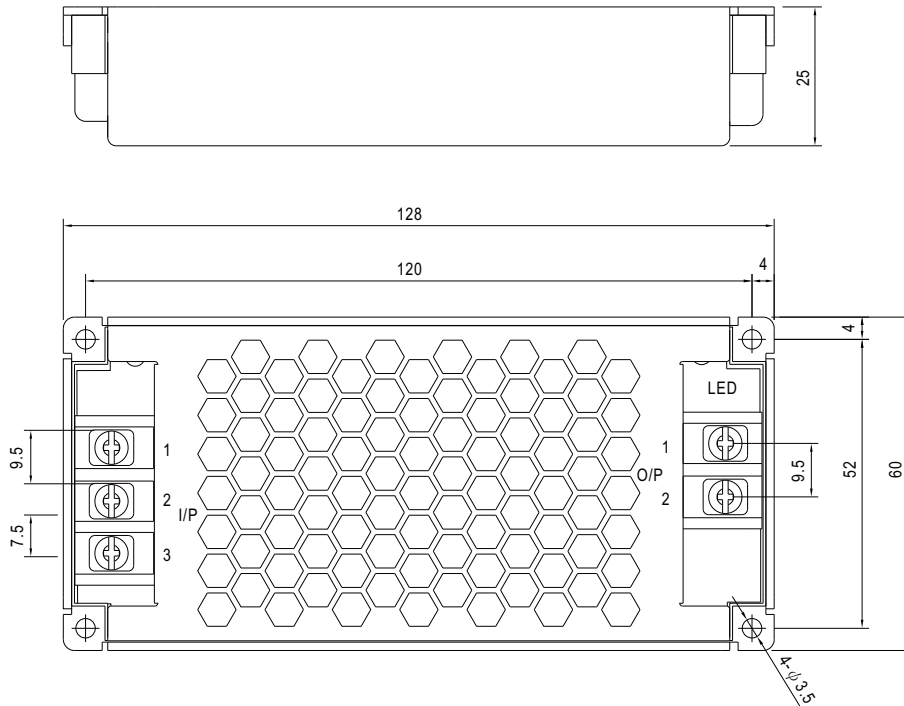

Input Terminal Pin No. Assignment :

Pin No.	Assignment
1	DC INPUT V+
2	DC INPUT V-
3	FG \perp

Output Terminal Pin No. Assignment :

Pin No.	Assignment
1	DC OUTPUT -V
2	DC OUTPUT +V

■ Installation Manual

Please refer to : <http://www.meanwell.com/manual.html>