

Dimension			
L	W	H	
330	140	41 (1U)	mm
13	5.5	1.61(1U)	inch



Features

- 1U low profile design
- Full digital design with 93% conversion efficiency for both AC/DC and DC/AC conversion
- Ultrafast switching time between AC/DC and DC/AC of 1 ms
- CB/TUV/UL 62368-1 certified, and design refer to IEC 62477 regulation
- Active current sharing up to 11000W(4+1)
- <3% Low THDi in both conversion mode
- Force charging and discharging mode with CANBus model
- Complete protections: Anti-islanding protection, AC fail protection, DC OVP, OLP, OCP, OTP
- 5 years warranty

Applications

- Battery cell formation & grading
- V2G (Vehicle-to-grid) system
- Marine battery charger module
- Electric scooter or vehicle charger station
- Kinetic energy recovery system
- Electrolysis system
- Wastewater treatment system

Description

The BIC-2200 is a 2.2KW bidirectional power supply with energy recycle function. It is fully digital and 1U height designed. It is designed to control the power transferred from AC grid to DC and DC to AC grid for energy recycle. The implementation of a bidirectional power supply of the BIC-2200 allows battery manufactures to charge the battery from AC grid and recycle the DC energy back into AC grid in one single unit. With built-in functions such as active current sharing, remote ON/OFF control and CANBus model available, the BIC-2200 provides vast design flexibility for battery formation & test equipment, V2G(Vehicle-to-grid) system, charging station, laser system and kinetic recovery system.

Model Encoding / Order Information

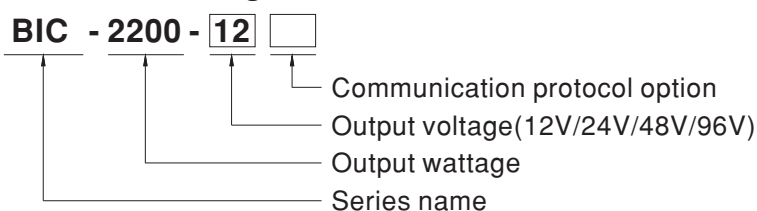

Type	Communication Protocol	Note
Blank	None protocol	In Stock
CAN	CANBus protocol	In Stock

SPECIFICATION

MODEL	BIC-2200-12	BIC-2200-24	BIC-2200-48	BIC-2200-96	
AC to DC Direction	DC VOLTAGE	12V	24V	48V	96V
	RATED CURRENT	180A	90A	45A	22.5A
	RATED POWER	2160W			
	FULL POWER VOLTAGE RANGE	12 ~ 15V	24 ~ 28V	48 ~ 65V	96 ~ 112V
	RIPPLE & NOISE (max.) Note.2	160mVp-p	260mVp-p	300mVp-p	480mVp-p
	VOLTAGE ADJ. RANGE	10 ~ 15V	19 ~ 28V	38 ~ 65V	76 ~ 112V
	CURRENT RANGE	0 ~ 180A	0 ~ 90A	0 ~ 45A	0 ~ 22.5A
	VOLTAGE TOLERANCE Note.3	± 1.0%	± 1.0%	± 1.0%	± 1.0%
	LINE REGULATION	± 0.5%	± 0.5%	± 0.5%	± 0.5%
	LOAD REGULATION	± 0.5%	± 0.5%	± 0.5%	± 0.5%
SETUP, RISE TIME	1800ms, 60ms/230VAC at full load				
INPUT	AC VOLTAGE RANGE	180 ~ 264VAC			
	FREQUENCY RANGE	47 ~ 63Hz			
	POWER FACTOR (Typ.)	0.98/230VAC at full load			
	EFFICIENCY (Typ.) Note.5	90%	93%	93%	93%
	AC CURRENT (Typ.)	11A/230VAC			
	INRUSH CURRENT (Typ.)	COLD START 35A/230VAC			
	LEAKAGE CURRENT	<2mA/230VAC			
TOTAL HARMONIC DISTORTION	<3%(@load=100%/230VAC)				
DC to AC Direction	RATED INPUT POWER	1800W			
	FULL POWER VOLTAGE RANGE	12 ~ 15V	24 ~ 28V	48 ~ 65V	96 ~ 112V
	DC VOLTAGE RANGE	10 ~ 15V	19 ~ 28V	38 ~ 65V	76 ~ 112V
	MAX. INPUT CURRENT	150A	75A	37.5A	18.75A
	RATED OUTPUT POWER (Typ.) (@230V, 50Hz)	1725VA			
	VOLTAGE RANGE	180 ~ 264VAC determined by AC main			
	FREQUENCY RANGE	47 ~ 63Hz determined by AC main			
	AC CURRENT (Typ.)	7.5A/230VAC			
	POWER FACTOR (Typ.)	0.99/230VAC at full load			
	EFFICIENCY (Typ.) Note.5	90.5%	93%	93%	93%
TOTAL HARMONIC DISTORTION	<3%(@load=100%/230VAC)				
PROTECTION	OVER LOAD	105 ~ 115% rated output power AC to DC Constant current limiting, shut down DC O/P voltage 5 sec. after DC O/P voltage is down low, re-power on to recover DC to AC Not accurate with constant power design			
	SHORT CIRCUIT	Shut down O/P current, re-power on to recover			
	OVER VOLTAGE	17.6 ~ 20.8V	33.6 ~ 39.2V	72.6 ~ 86V	134 ~ 157V
	OVER TEMPERATURE	Protection type : Shut down O/P voltage, re-power on to recover			
	ISLANDING PROTECTION	Shut down AC O/P voltage, re-power on to recover			
FUNCTION	REMOTE ON-OFF CONTROL	By electrical signal or dry contact Short: Power ON Open: Power OFF Please refer to the Function Manual in following			
	BIDIRECTION SWITCH TIME (Typ.)	1ms			
	ALARM SIGNAL	Isolated TTL signal output for T-Alarm, DC-OK and Fault. Please refer to the Function Manual in following pages			
	AUXILIARY POWER	12V@0.5A tolerance ± 5%, ripple 150mVp-p			
	BATTERY MODE RATED CURRENT(default) Note.7	AC to DC Can be adjusted by communication	160A 80A	40A	20A
ENVIRONMENT	WORKING TEMP.	-30 ~ +70°C (Refer to "Derating Curve")			
	WORKING HUMIDITY	20 ~ 90% RH non-condensing			
	STORAGE TEMP., HUMIDITY	-40 ~ +85°C, 10 ~ 95% RH non-condensing			
	TEMP. COEFFICIENT	± 0.03%/°C (0 ~ 45°C)			
	VIBRATION	10 ~ 500Hz, 2G 10min./1cycle, 60min. each along X, Y, Z axes			
SAFETY & EMC (Note 4)	SAFETY STANDARDS	UL62368-1, CAN/CSA C22.2 No.62368-1,TUV BS EN/EN62368-1, EAC TP TC 004, IEC62477-1(by request) approved			
	WITHSTAND VOLTAGE Note.8	I/P-O/P:3KVAC I/P-FG:2KVAC O/P-FG:500VAC			
	ISOLATION RESISTANCE Note.8	I/P-O/P, I/P-FG, O/P-FG:100M Ohms / 500VDC / 25°C / 70% RH			
	EMC EMISSION	BS EN/EN55032			
		Parameter	Standard		Test Level / Note
		Conducted	BS EN/EN55032 (CISPR32)		Class B
		Radiated	BS EN/EN55032 (CISPR32)		Class A
		Harmonic Current	BS EN/EN61000-3-2		Class A
	EMC IMMUNITY	Voltage Flicker			
		BS EN/EN61000-3-3			
BS EN/EN55035, BS EN/EN61000-6-2					
Parameter		Standard		Test Level / Note	
ESD		BS EN/EN61000-4-2		Level 3, 8KV air ; Level 2, 4KV contact	
Radiated		BS EN/EN61000-4-3		Level 3	
EFT / Burst		BS EN/EN61000-4-4		Level 3	
Surge	BS EN/EN61000-6-2		2KV/Line-Line 4KV/Line-Earth		
Conducted	BS EN/EN61000-4-6		Level 3		
Magnetic Field	BS EN/EN61000-4-8		Level 4		
Voltage Dips and Interruptions	BS EN/EN61000-4-11		>95% dip 0.5 periods, 30% dip 25 periods, >95% interruptions 250 periods		
OTHERS	MTBF	155.56K hrs min. Telcordia SR-332 (Bellcore) ; 46K hrs min. MIL-HDBK-217F (25°C)			
	DIMENSION	330*140*41mm (L*W*H)			
	PACKING	2.9Kg; 4pcs/12.6Kg/1.25CUFT			
NOTE	<ol style="list-style-type: none"> All parameters NOT specially mentioned are measured at 230VAC input, rated load and 25°C of ambient temperature. Ripple & noise are measured at 20MHz of bandwidth by using a 12" twisted pair-wire terminated with a 0.1uF & 47uF parallel capacitor. Tolerance : includes set up tolerance, line regulation and load regulation. Need additional EMI filter to meet regulations of EMC conducted and radiated emission. Characteristics of EMI filter please refer to the table, minimum insertion loss. The efficiency is measured at 75% load. The ambient temperature derating of 5°C/1000m with fan models for operating altitude higher than 2000m(6500ft). CANBus model only. During withstands voltage and isolation resistance testing, the screw "A" shall be temporarily removed, and shall be installed back after the testing As a constant power output, the driver will auto derating the current limitation when voltage raise above rated voltage(12V,24V,48V,96V) in order to remain 1800W output. On the other hand, when voltage is below rated voltage(12V,24V,48V,96V), the maximum current limitation will set at Max input current. <p>※ Product Liability Disclaimer : For detailed information, please refer to https://www.meanwell.com/serviceDisclaimer.aspx</p>				

■ BLOCK DIAGRAM

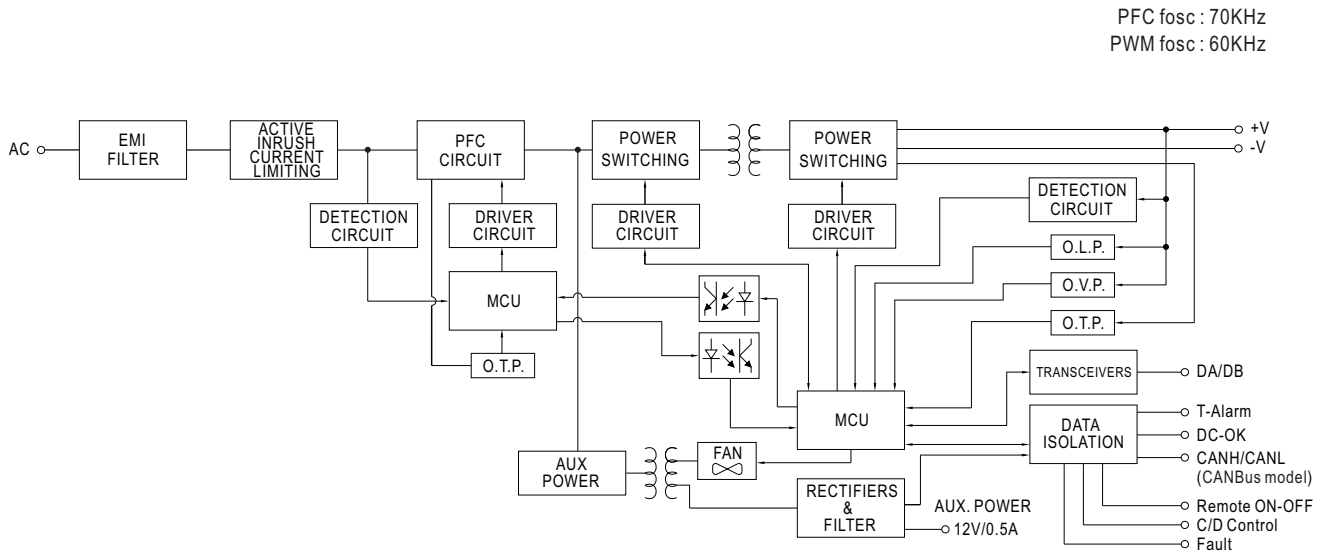

■ DERATING CURVE

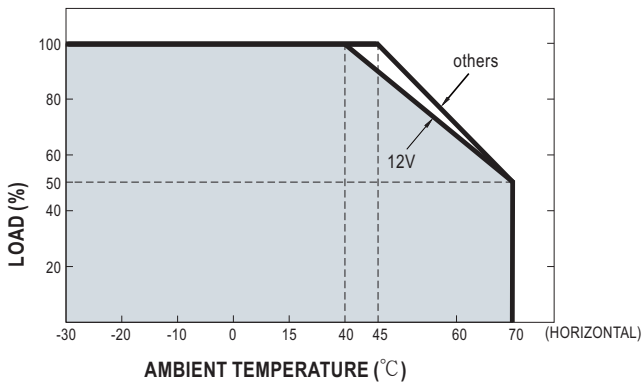

■ STATIC CHARACTERISTICS

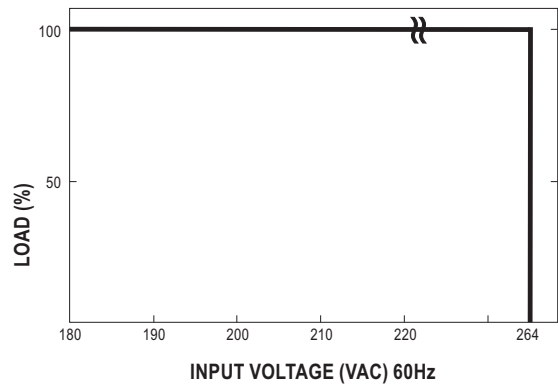

MECHANICAL SPECIFICATION

Case No. 277C

Unit:mm

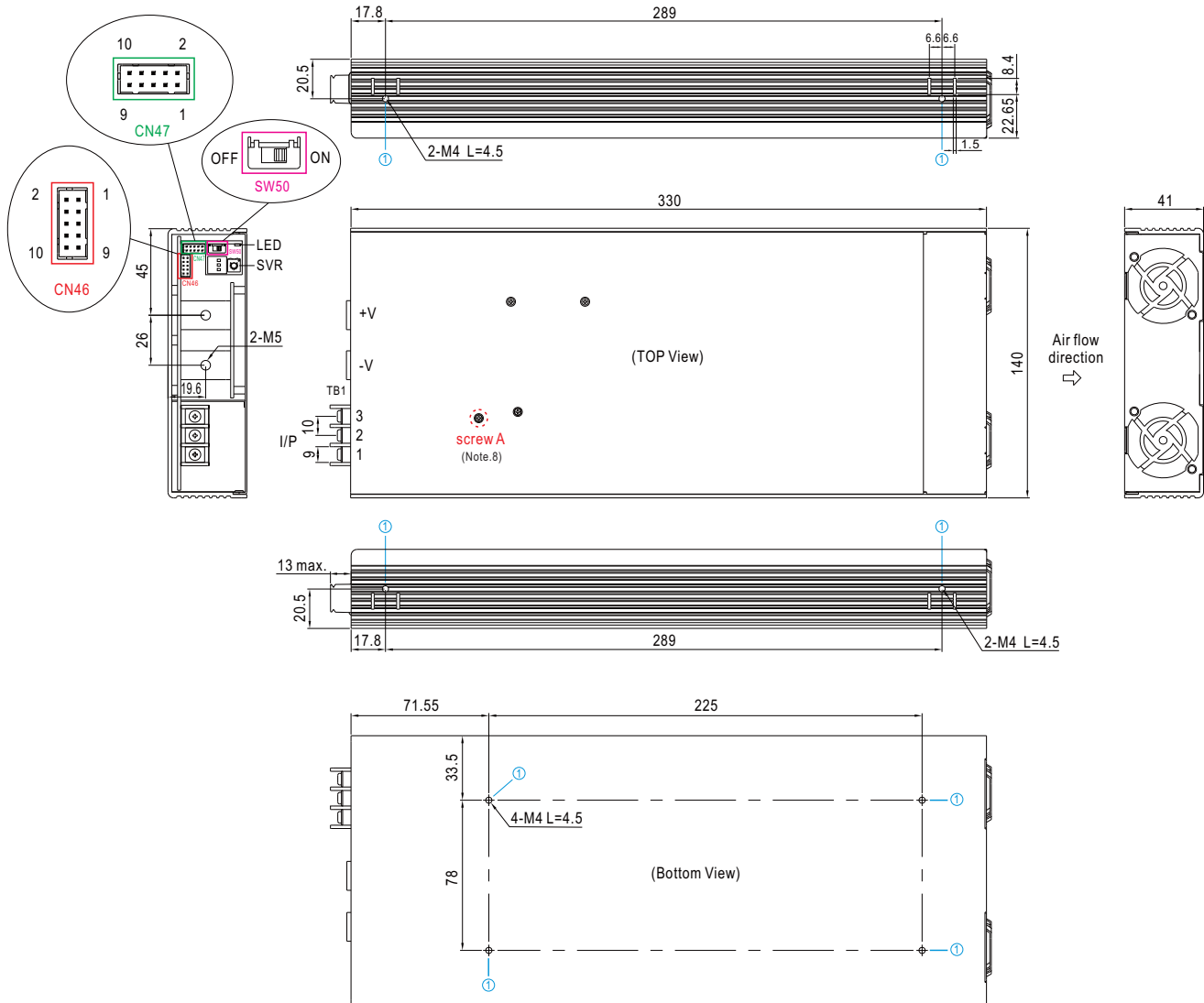

AC Input Terminal(TB1) Pin NO. Assignment

Pin No.	Assignment	Terminal	Max mounting torque
1	AC/L	DECA T35-EO32-03	18Kgf-cm
2	AC/N		
3	FG \perp		

DC Output Terminal Pin No. Assignment

Assignment	Diagram	Maximum mounting torque
+V, -V		10Kgf-cm

LED Status Indicators

LED	Description
	Green AC to DC Direction, functions as regular power supply.
	Green DC to AC Direction, functions as grid inverter.
	Red Abnormal status (Over temperature protection, Overload protection, Fan fail.)

- Light
- Flash

Mounting Instruction

Hole No.	Recommended Screw Size	MAX. Penetration Depth L	Recommended mounting torque
①	M4	4.5mm	7~10Kgf-cm

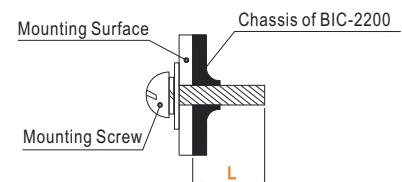

※Control Pin No. Assignment(CN46) : HRS DF11-10DP-2DS or equivalent

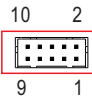

Mating Housing	HRS DF11-10DS or equivalent
Terminal	HRS DF11-10SC or equivalent

Pin No.	Function	Description
1	+12V-AUX	Auxiliary voltage output, 11.4~12.6V, referenced to GND-AUX (pin 2,4). The maximum output current is 0.5A. This output is not controlled by the Remote ON/OFF control.
2,4	GND-AUX	Auxiliary voltage output GND. The signal return is isolated from the output terminals (+V & -V).
3	+5V-AUX	Auxiliary voltage output, 4.5~5.5V, referenced to GND-AUX (pin 2,4) only for Remote ON/OFF used. This output is not controlled by the Remote ON/OFF control.
5	Remote ON-OFF	The unit can turn the output ON/OFF by electrical signal or dry contact between Remote ON/OFF and +5V-AUX(pin 3). (Note.1)
6	C/D Control (Note.2)	High (4.5 ~ 5.5V) : Battery Charging mode Low (-0.5 ~ 0.5V) : Battery Discharging mode (Note.1)
7	DC-OK	High (4.5 ~ 5.5V) : When the $V_{out} \leq 80\% \pm 5\%$. Low (-0.5 ~ 0.5V) : When $V_{out} \geq 80\% \pm 5\%$. The maximum sourcing current is 4mA and only for output. (Note.1)
8	Fault	High (4.5 ~ 5.5V) : When the $V_{ac} \leq 165V_{rms}$, OLP, SCP, OTP, OVP, AC Fail, fan lock, islanding protection. Low (-0.5 ~ 0.5V) : When $V_{ac} \geq 175V_{rms}$ and when power supply work normally. The maximum sourcing current is 4mA and only for output. (Note.1)
9	T-ALARM	High (4.5 ~ 5.5V) : When the internal temperature exceeds the limit of temperature alarm, or when any of the fans fails. Low (-0.5 ~ 0.5V) : When the internal temperature is normal, and when fans work normally. The maximum sourcing current is 4mA and only for output(Note.1)
10	NC	-----

Note 1 : Isolated signal, referenced to GND-AUX.
Note 2 : CANBus model only.

※Control Pin No. Assignment(CN47): HRS DF11-10DP-2DS or equivalent



Mating Housing	HRS DF11-10DS or equivalent
Terminal	HRS DF11-10SC or equivalent

Pin No.	Function	Description
1,2	DA	Differential digital signal for parallel control. (Note.1)
3,4	DB	
5,6	GND	Negative output voltage signal. Certain function reference. It can not be connected directly to the load.
7	CANH (CANBus model)	For CANBus model: Data line used in CANBus interface. (Note.2)
8	CANL (CANBus model)	For CANBus model: Data line used in CANBus interface. (Note.2)
9,10	GND-AUX	Auxiliary voltage output GND. The signal return is isolated from the output terminals (+V & -V).

Note 1 : Non-isolated signal, referenced to GND.
Note 2 : Isolated signal, referenced to GND-AUX.

◎ Bidirection process

BIC-2200 possesses AC to DC and DC to AC two way conversion functions. The conversion direction can be automatically detected and controlled by BIC-2200's internal firmware or manually switched by users according to different application requirements. Before entering detailed function explanation. Please refer to following definitions.

AC to DC (Energy absorbing and charging/ power supplying):

The BIC-2200 converts AC energy from the grid into DC energy for the battery or the loads. The operation principle is the same as an ordinary power supply or a charger.



DC to AC (Energy recycling and discharging):

Opposite to the AC to DC conversion, the BIC-2200 converts DC energy from the battery or loads into AC energy, then feeding back to the grid. AC output synchronization range is 180Vac~264Vac/47Hz~63Hz, the bidirectional power supply can work normally as long as the AC grid is within the range.



Bi-direction auto-detect mode:

This is default factory setting, BIC-2200 operates as table below

Condition	Mode
Set voltage > load voltage	AC to DC
Set voltage < load voltage	DC to AC

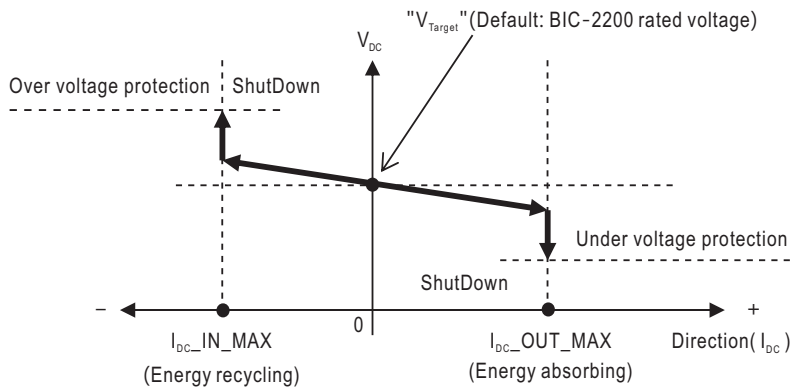

Operating characteristic curve

Note:Detail of set voltage, please refer to user's manual.

Bi-direction battery mode:

This mode only can be activated by CANBus model. Set the BIC-2200 in AC to DC (charging) or DC to AC (discharging) conversion directly through command DIRECTION_CTRL below.

Command	Conversion
DIRECTION_CTRL = 00h	AC to DC (charging)
DIRECTION_CTRL = 01h	DC to AC (discharging)

◎ Current Sharing

BIC-2200 has the built-in active current sharing function and can be connected in parallel, up to 5 units, to provide higher output power as exhibited below :

- ※ The power supplies should be paralleled using short and large diameter wiring and then connected to the load.
- ※ In parallel connection, power supply with the highest output Voltage will be the master unit and its Vout will be the DC bus voltage.
- ※ The total output current must not exceed the value determined by the following equation:

$$\text{Maximum output current at parallel operation} = (\text{Rated current per unit}) \times (\text{Number of unit}) \times 0.95$$
- ※ When the total output current is less than 5% of the total rated current, or say $(5\% \text{ of Rated current per unit}) \times (\text{Number of unit})$ the current shared among units may not be balanced.
- ※ Under parallel operation ripple of the output voltage may be higher than the SPEC at light load condition. It will go back to normal ripple level once the output load is more than 5%.
- ※ CN47/SW50 Function pin connection

Parallel	PSU1		PSU2		PSU3		PSU4		PSU5	
	CN47	SW50	CN47	SW50	CN47	SW50	CN47	SW50	CN47	SW50
1 unit	X	ON	—	—	—	—	—	—	—	—
2 unit	V	ON	V	ON	—	—	—	—	—	—
3 unit	V	ON	V	OFF	V	ON	—	—	—	—
4 unit	V	ON	V	OFF	V	OFF	V	ON	—	—
5 unit	V	ON	V	OFF	V	OFF	V	OFF	V	ON

(V : CN47 connected ; X : CN47 not connected)

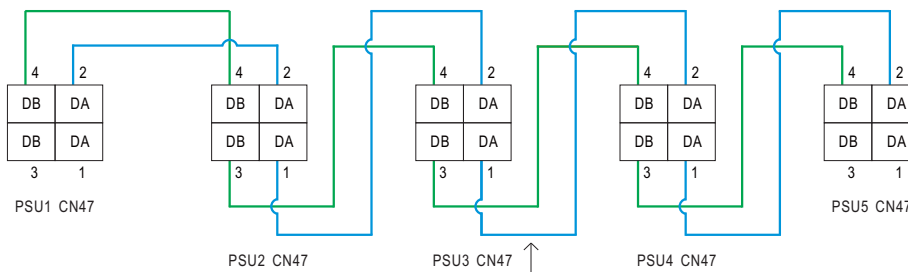
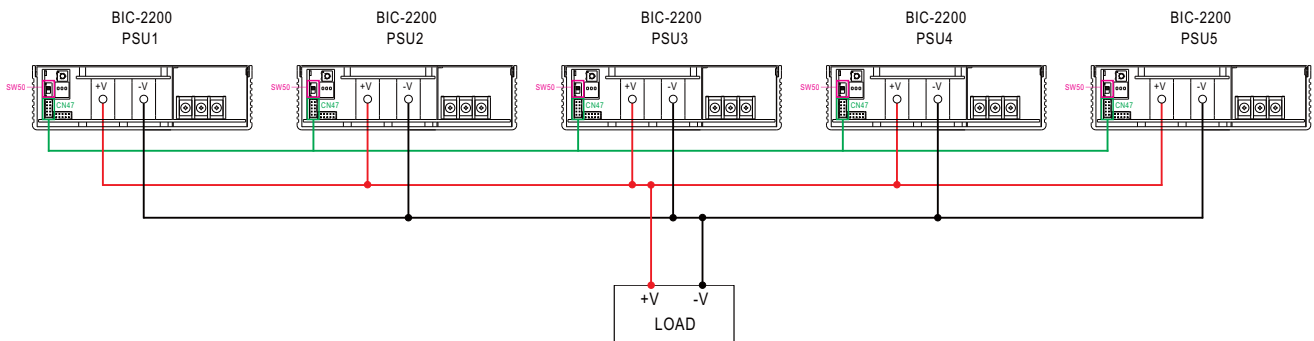

If the lines of CN47 are too long, they should be twisted in pairs to avoid the noise.

◎ DA, DB connected mutually in parallel.

GUIDANCE OF ADDITIONAL FILTER

1.Schematic

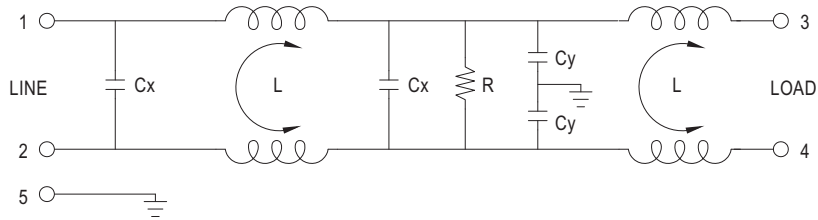

2.Minimum insertion loss (In dB at 50 Ω system): Filter model 30DPGS5C or equivalent

FREQ. MHz	0.01	0.05	0.10	0.15	0.50	1.0	5.0	10	30
COM. MODE dB	2	5	8	10	30	35	55	45	30
DIF. MODE dB	4	15	18	18	45	50	40	40	40

3.Configuration

