

N20/30

FF030

RF130

BLDC
1632

FF130

FF180

RF500

RF300

RF310

094

BLDC
2035

370

2418

2430

385

2838

395

30-C

32-C

40-C

32ZY13

32ZY25

520

BLDC
520

380

555

BLDC
3640

775

38S

BLDC
38S

45S

BLDC
45S

50S

BLDC
50S

60S

BLDC
60S

80S

稳压器

同步
电机永磁
直流电机交流
可逆电机

A60KTYZ AC Synchronous Gear Motor



Dimension(mm)

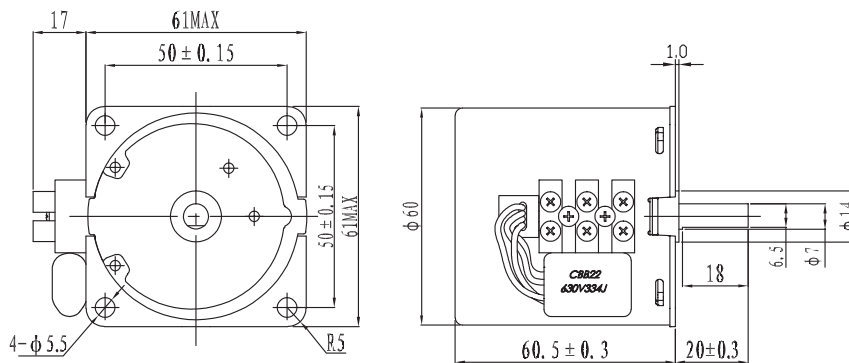

Working Conditions

Environment Temp.	-15 ~ +45° C
Humidity	15% ~ 90%RH
Working Volt.	85% ~ 110% of Nominal Volt.
Frequency	Nominal Frequency ±3%
Installation	Shaft keep horizontally or upward

Technical Data

Nominal Volt. (V)	220											
Nominal Frequency (HZ)	50-60											
Working Duty (S)	S1											
Capicitor applicable (μF)	0.33											
Input Power (W)	< 10											
Input Current (mA)	< 45											
Output speed (r/min)	2.5	5	10	15	20	30	40	50	60	80	110	
Output torque (Kg/cm)	75	45	24	16	12	8	6	4.8	4	3	2	
Direction	CW/CCW											
Insulation Class	E											
Dielectric Strength	1800V/S											
Temp.rising (K)	< 65											
Noise (dB)	小于 45											

Note : If you need different power, or special desgin on shaft, please inquiry us.