

MEMS Gauge Pressure Sensor 2SMPP

MEMS Gauge Pressure Sensor Featuring Small Size and Low Power Consumption

- Ultra-miniature 6.1 × 4.7 × 8.2 mm (L × W × H).
- Piezo Resistive element provides electrical characteristics that are superior to capacitive type pressure sensors.
- 0 to 37 kPa (2SMPP-02) or -50 to 50 kPa (2SMPP-03) pressure range.
- Low Power consumption of 0.2 mW
- Low Temperature Influence
- RoHS Compliant

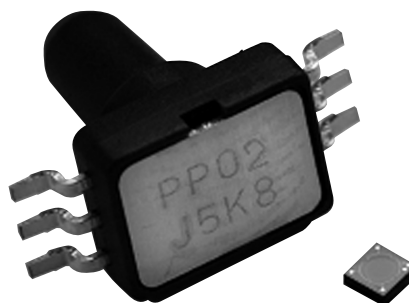

Ordering Information

Standard Models with Surface mount package

Classification	Pressure Range	Structure	Packaging	Model
Bottom Port Type	0 to 37 kPa	SOP	Plastic sleeve	2SMPP-02
	-50 to 50 kPa			2SMPP-03

Terminal Arrangement

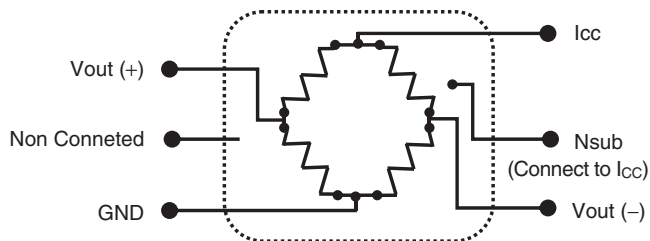

Application Examples

- Medical equipment
- Home appliance
- Air movement control
- Level indicators
- Leak detection
- Pressure controller

Specifications

■ Ratings

Item	2SMPP-02	2SMPP-03
Pressure type	Gauge Pressure	
Sensing type	Piezo Resistive	
Applicable gases	Air (Non-corrosive, dust free)	
Ratings	Pressure range	0 to 37 kPa
	Withstand pressure	Max. 53 kPa
	Supply current	100 μ ADC (130 μ ADC absolute max.)
	Ambient operating temperature	0 to 50°C (with no icing or condensation)
	Ambient operating humidity	15 to 90%RH (with no icing or condensation)
	Ambient storage temperature	-30 to 85°C (with no icing or condensation)
	Ambient storage humidity	10 to 95%RH (with no icing or condensation)

Note: 1. The above values are initial values measured at ambient temperature condition of 23°C.

2. Please avoid caustic gases.
3. Standard 2SMPP-02 product is not calibrated for negative pressures.

■ Electrical Characteristics

Item	2SMPP-02	2SMPP-03	
Pressure type		Positive	Negative
Operating pressure range	0 to 37 kPa	0 to 50 kPa	-50 to 0 kPa
Bridge resistance	20 \pm 2 k Ω		
Offset voltage (See note 2.)	-2.5 \pm 4.0 mV		
Span voltage (See note 2.)	31.0 \pm 3.1 mV (at 37 kPa)	42.0 \pm 5.5 mV (at 50 kPa)	-43.0 \pm 5.5 mV (at -50 kPa)
Non-Linearity (See note 2.)	0 \pm 0.8%FS (0 to 37 kPa)	0.8 \pm 0.5%FS (at 50 kPa)	0.2 \pm 0.5%FS (at -50 kPa)
Hysteresis (See note 2.)	0 \pm 0.5%FS (0 to 37 kPa)	0 \pm 0.2%FS (-50 to 50 kPa)	
Temperature influence of Span	0.5 \pm 1.0%FS (at 0°C)	1.0 \pm 2.0%FS (at 0°C)	0.8 \pm 2.0%FS (at 0°C)
	0.3 \pm 1.0%FS (at 50°C)	-0.1 \pm 2.0%FS (at 50°C)	0.1 \pm 2.0%FS (at 50°C)
	---	1.0 \pm 3.0%FS (at 85°C)	1.2 \pm 3.0%FS (at 85°C)
Temperature influence of Offset	0 \pm 3.0%FS (0 to 25°C)	-1.0 \pm 3.0%FS (at 0°C)	
	0 \pm 3.0%FS (25 to 50°C)	1.0 \pm 3.0%FS (at 50°C)	
	---	2.0 \pm 5.0%FS (at 85°C)	

Note: 1. The above values are initial values measured at ambient temperature condition of 23°C.

2. Not including temperature influence.
3. The above values are operated at 100 μ ADC

■ Environment Characteristics

Item	2SMPP-02	2SMPP-03
Vibration resistance	Destruction	10 Hz to 500 Hz 10 G
	Malfunction	10 Hz to 500 Hz 10 G
Shock resistance	Destruction	15 G
	Malfunction	15 G
Life Expectancy	300,000 Operations min. (0 to 39 kPa)	100,000 Operations min. (0 to 75 kPa)
ESD	1000 V (Human body model)	
Weight	0.17 g	
Package Material	PPS (Polyphenylenesulfide)	

Engineering Data (for reference)

■ Output Characteristics - 2SMPP-02

Rated Pressure vs. Output Voltage

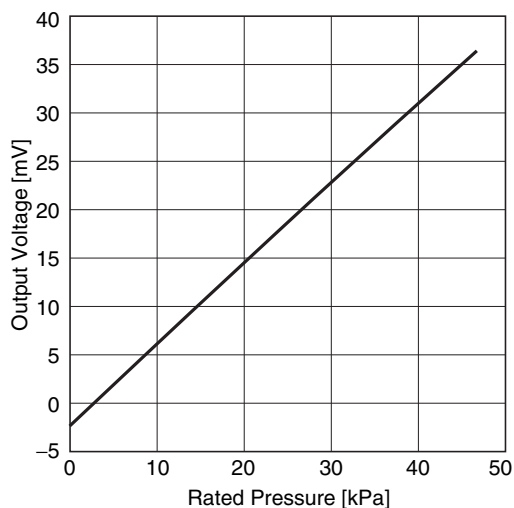

- Note:**
1. Ambient temperature condition: 25°C
 2. Drive current: 100 μ A
 3. These output voltage characteristics are measured with tester without a mounting board.
 4. The output voltage characteristics may be influenced by the mounting board. Be sure to check operation including durability in actual equipment before use.

Temperature influence of Span voltage

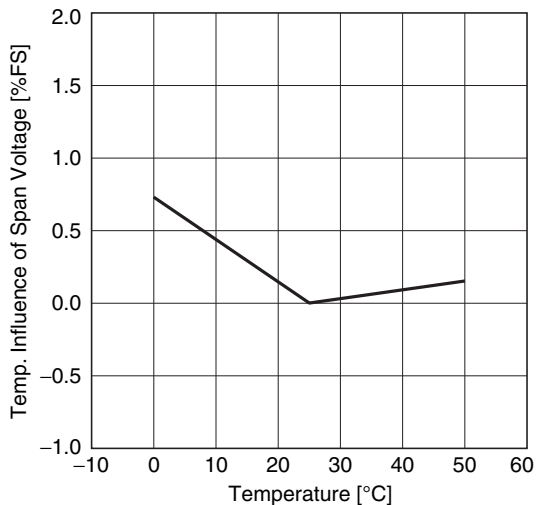

Temperature influence of Offset voltage

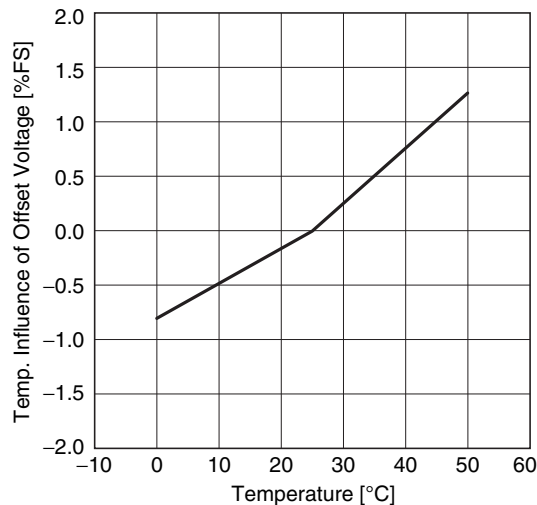

- Note:**
1. Measured points are 0°C and 25°C, 50°C
 2. Drive current: 100 μ A
 3. These output voltage characteristics are measured with tester without a mounting board.
 4. The output voltage characteristics may be influenced by the mounting board. Be sure to check operation including durability in actual equipment before use.

Pressure cycle range (0 to 40 kPa)

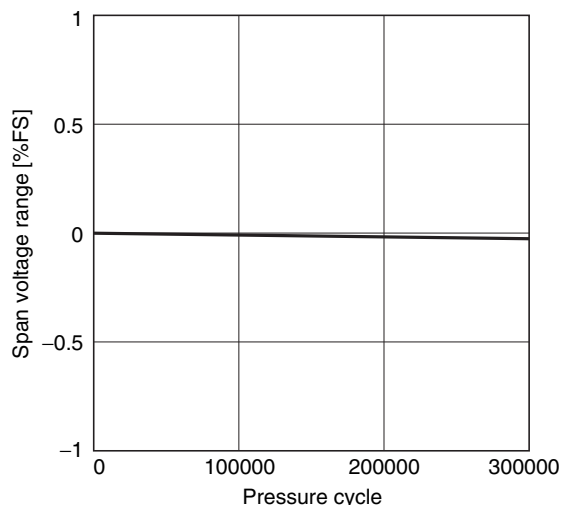
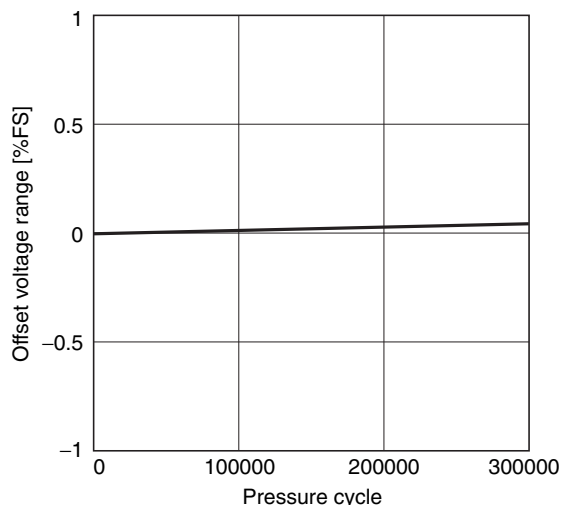

- Note:**
1. Tested temperature condition: 25°C
 2. Number of pressure cycle time: 3×10^5
 3. Rated cycle pressure: 0 to 40 kPa
 4. These output voltage characteristics are measured with tester without a mounting board.

■ Output Characteristics - 2SMPP-03

Rated Pressure vs. Output Voltage

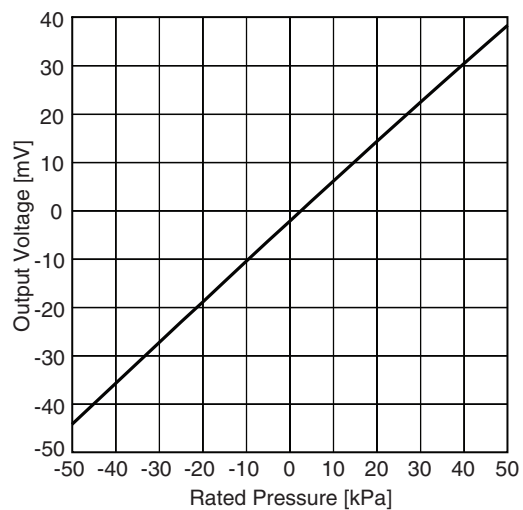

- Note:**
1. Ambient temperature condition: 25°C
 2. Drive current: 100 μ A
 3. These output voltage characteristics are measured with tester without a mounting board.
 4. The output voltage characteristics may be influenced by the mounting board. Be sure to check operation including durability in actual equipment before use.

Temperature influence of Span voltage (at 50 kPa)

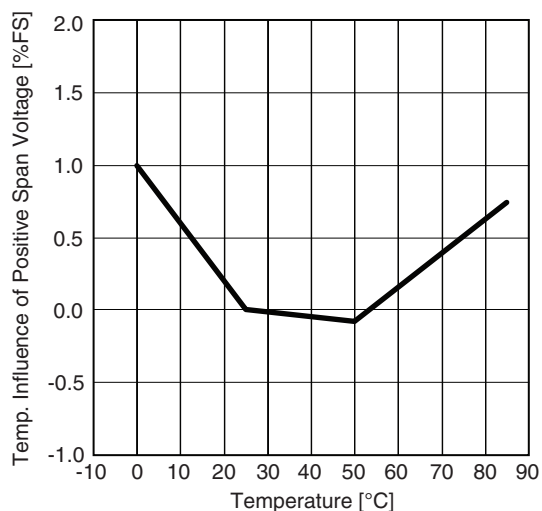

Temperature influence of Offset voltage (at 0 kPa)

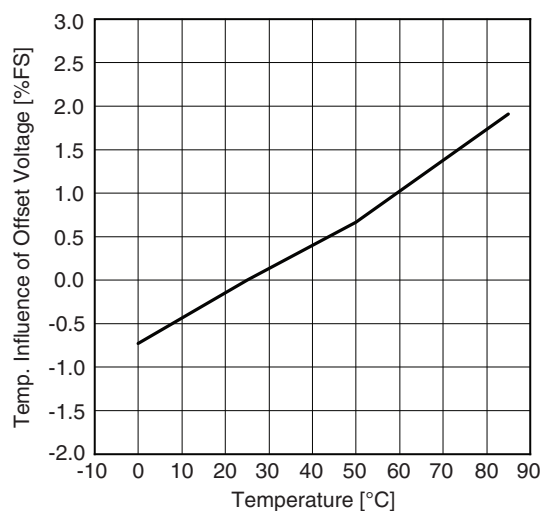

- Note:**
1. Measured points are 0°C, 25°C, 50°C and 85°C at 0 to 50 kPa.
 2. Drive current: 100 μ A
 3. These output voltage characteristics are measured with tester without a mounting board.
 4. The output voltage characteristics may be influenced by the mounting board. Be sure to check operation including durability in actual equipment before use.

Pressure cycle range (0 to 75 kPa)

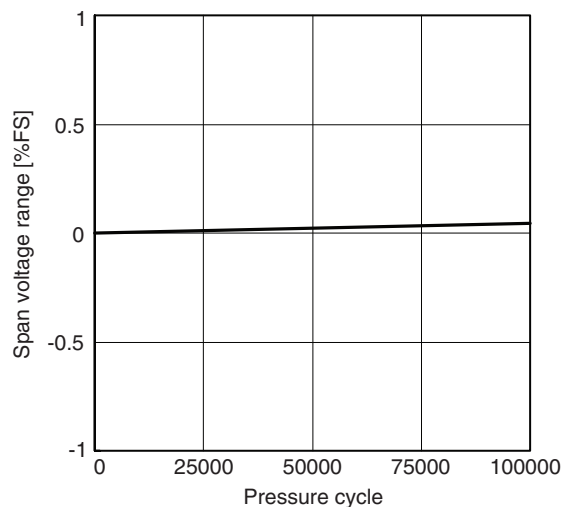
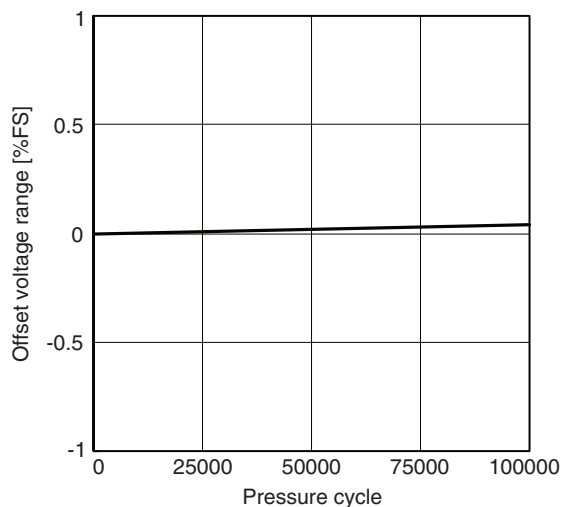

- Note:**
1. Tested temperature condition: 25°C
 2. Number of pressure cycle time: 1×10^5
 3. Rated cycle pressure: 0 to 75 kPa
 4. These output voltage characteristics are measured with tester without a mounting board.

Example of application circuit for MEMS Pressure Sensor

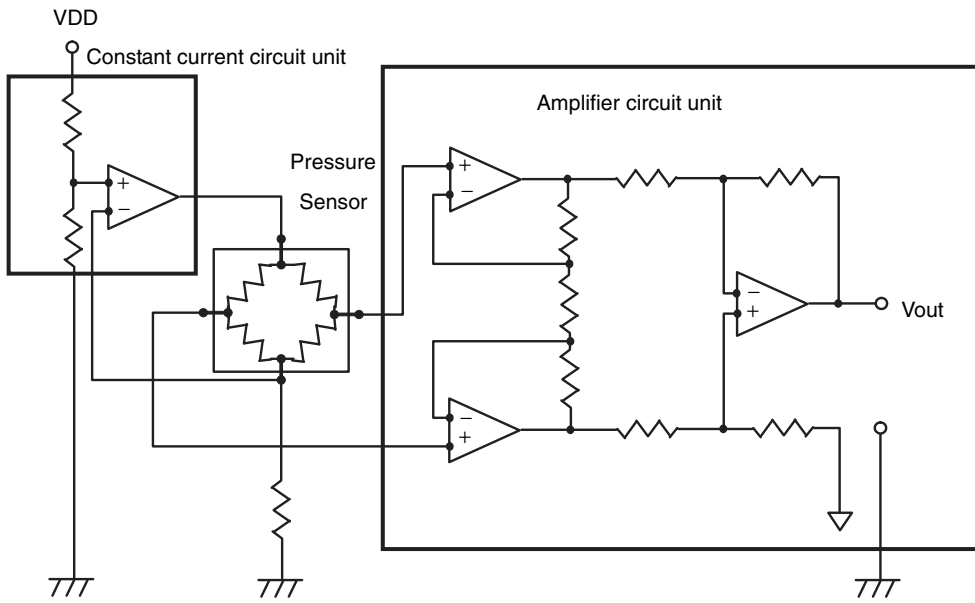

1. The pressure sensor is designed to convert a voltage by means of constant current drive.
2. Please amplify the output voltage of the pressure sensor by using the amplifying circuit if necessary.

Dimensions

Note: All units are in millimeters unless otherwise indicated.

2SMPP-02 2SMPP-03

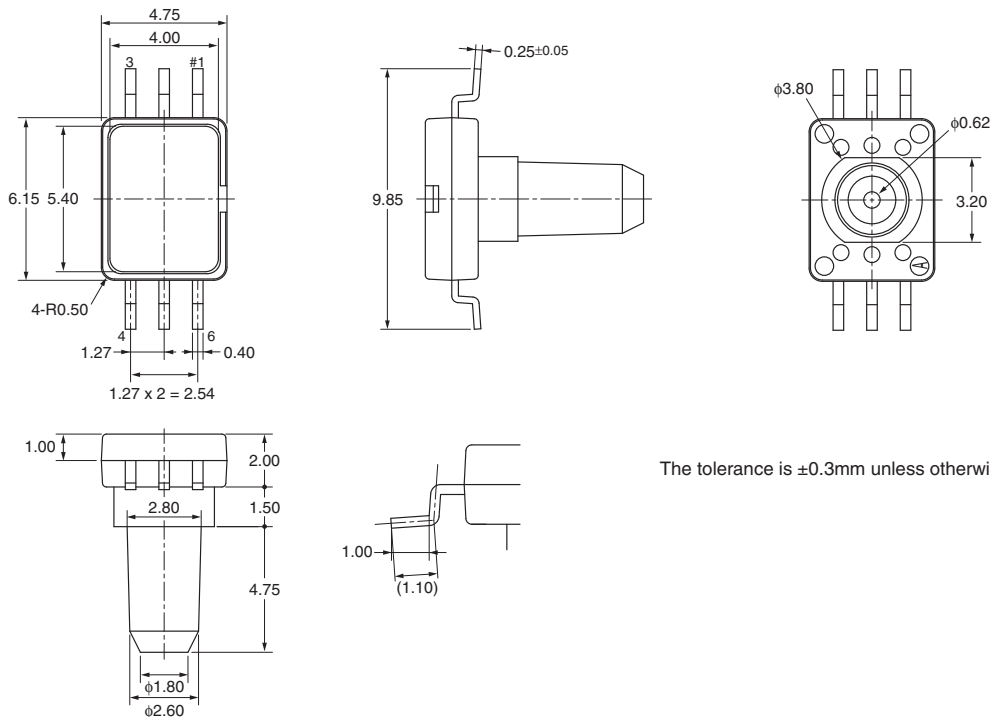

The tolerance is ±0.3mm unless otherwise specified.

Top view

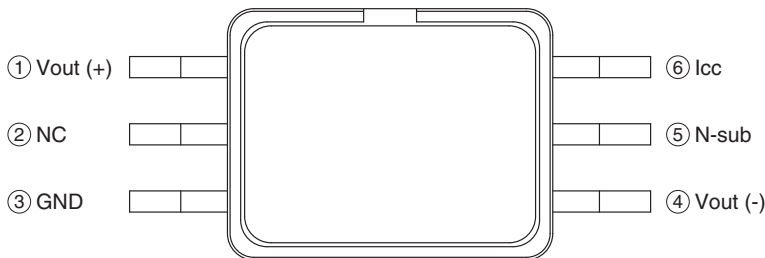

Marking

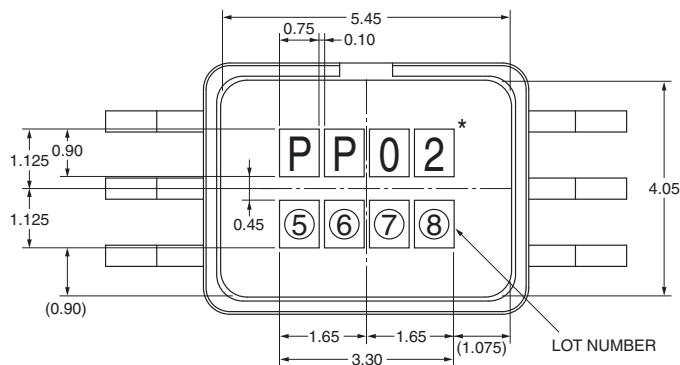

*part will be marked "PP03" for 2SMPP-03

Precautions

■ Precautions for Correct Use

Handling

- Only air can be used as pressure media on the products directly. It is prohibited to use pressure media including corrosive gases (e.g. organic solvents gases, sulfur dioxide and hydrogen sulfide gases), fluid and any other foreign materials.
- The products are not water proof. Please keep dry in use.
- Don't use the products under dew-condensing conditions. Frozen fluid on sensor chips may also cause fluctuation of sensor output and other troubles.
- Don't put foreign materials (e.g. a wire or pin) into connecting tube. It may cause breakage of pressure sensor chips or fluctuation of sensor output caused by clogging the tube.
- Use the products within rated pressure. Usage at pressure out of the range may cause breakage.
- Don't use under high-frequency vibration including ultrasonic wave.
- The products may be broken by static electricity. Charged materials (e.g. a workbench and a floor) and workers must provide measures against static electricity, including ground connection.
- Overpowering terminals may deform them and detract their solderability. Don't drop or handle the products roughly.
- Don't use the products under humid or dusty condition.
- Terminals connection of pressure sensors must be handled as directed by a connection diagram.

Environmental Conditions for Transport and Storage

- It is prohibited to keep the products with corrosive gases (e.g. organic solvents gases, sulfur dioxide and hydrogen sulfide gases).
- The products are not water proof. Please keep dry during storage.
- An anti-static treatment has been applied to the sleeves. Please note the following points.
 1. Getting wet may remove an anti-static treatment and eliminate its effect.
 2. The sleeves may feel sticky under hot and humid condition due to the nature of the anti-static treatment.
 3. Anti-static has aging degradation. It is prohibited to keep the sleeves for more than six months. The sleeves are also non-reusable.
- Don't keep the products under humid or dusty condition.

Mounting

- Use lands on the printed-circuit boards to which the sensor can be securely fixed.
- Fix pin No.2 on the printed-circuit boards, not fixed causes fluctuation of sensor output signals.

Soldering

- Due to its small size, the thermal capacity of the pressure sensor is low. Therefore, take steps to minimize the effects of external heat.
- Dip soldering bath: Max.260°C, within 10 sec.
- Soldering iron: Max. 260°C, within 10 sec.
- Do not heat the case of sensor package, heat only terminal.
- Use a non-corrosive resin type of flux. Since the pressure sensor chip is exposed to the atmosphere, do not allow flux to enter inside.

Cleaning

- Since the pressure sensor chip is exposed to atmosphere, do not allow cleaning fluid to enter inside.
- Avoid ultrasonic cleaning since this may cause breaks or disconnections in the wiring.

Coating

- Do not coat the pressure sensor when it is mounted to the print circuit board.
- Do not wash the print circuit board after the pressure sensor is mounted using detergent containing silicone. Otherwise, the detergent may remain on the surface of the pressure sensor.

■ Definitions

1. Offset voltage is defined as the output voltage at 0 kPa rated pressure
2. Positive span voltage is defined as the algebraic difference between the output voltage at 50 kPa rated pressure and the output voltage at 0 kPa rated pressure. (37 kPa and 0 kPa for 2SMPP-02)
3. Negative span voltage is defined as the algebraic difference between the output voltage at -50 kPa rated pressure and the output voltage at 0 kPa rated pressure. (Not applicable for 2SMPP-02)
4. Hysteresis is defined as follows; {The maximum value of difference at the same pressure}/span voltage x 100 %FS
5. Temperature influence of span voltage is defined as follows;
 - {Span voltage at 0°C - span voltage at 25°C}/span voltage at 25°C x 100%FS
 - {Span voltage at 50°C - span voltage at 25°C}/span voltage at 25°C x 100%FS
 - {Span voltage at 85°C - span voltage at 25°C}/span voltage at 25°C x 100%FS - - - does not apply to 2SMPP-02
6. Temperature influence of offset voltage is defined as follows
 - {Offset voltage at 0°C - offset voltage at 25°C}/span voltage at 25°C x 100%FS
 - {Offset voltage at 50°C - offset voltage at 25°C}/span voltage at 25°C x 100%FS
 - {Offset voltage at 85°C - offset voltage at 25°C}/span voltage at 25°C x 100%FS - - - does not apply to 2SMPP-02



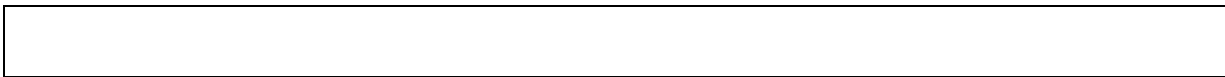

ALL DIMENSIONS SHOWN ARE IN MILLIMETERS.
To convert millimeters into inches, multiply by 0.03937. To convert grams into ounces, multiply by 0.03527.

OMRON[®]

**OMRON ELECTRONIC
COMPONENTS EUROPE B.V.**

Wegalaan 57
2132 JD Hoofdoorp, Netherland

847-882-2288

OMRON ON-LINE

Global - <http://www.omron.com>

EU - <http://www.components.omron.eu>

Cat. No. X305-E-1b

11/12

Specifications are subject to change without notice